



**LG**

Life's Good

# OWNER'S MANUAL

# LED TV

\* LG LED TV applies LCD screen with LED backlights.

Please read this manual carefully before operating your set and retain it for future reference.

47LA6900	47LA6950	47LA7400
55LA6900	55LA6950	55LA7400
		60LA7400

# IMPORTANT SAFETY INSTRUCTIONS

Always comply with the following precautions to avoid dangerous situations and ensure peak performance of your product.





**WARNING/CAUTION**

**RISK OF ELECTRIC SHOCK  
DO NOT OPEN**





TO REDUCE THE RISK OF ELECTRIC SHOCK DO NOT REMOVE COVER (OR BACK). NO USER SERVICEABLE PARTS INSIDE. REFER TO QUALIFIED SERVICE PERSONNEL.

 The lightning flash with arrowhead symbol, within an equilateral triangle, is intended to alert the user to the presence of uninsulated "dangerous voltage" within the product's enclosure that may be of sufficient magnitude to constitute a risk of electric shock to persons.

 The exclamation point within an equilateral triangle is intended to alert the user to the presence of important operating and maintenance (servicing) instructions in the literature accompanying the appliance.

**WARNING/CAUTION**  
- TO REDUCE THE RISK OF FIRE AND ELECTRIC SHOCK, DO NOT EXPOSE THIS PRODUCT TO RAIN OR MOISTURE.

 **WARNING**  
If you ignore the warning message, you may be seriously injured or there is a possibility of accident or death.

 **CAUTION**  
If you ignore the caution message, you may be slightly injured or the product may be damaged.

 **NOTE**  
The note helps you understand and use the product safely. Please read the note carefully before using the product.

ENGLISH

Read these instructions.  
Keep these instructions.  
Heed all warnings.  
Follow all instructions.

- Do not use this apparatus near water.

- Clean only with a dry cloth.

- Do not block any ventilation openings. Install in accordance with the manufacturer's instructions.

- Do not install near any heat sources such as radiators, heat registers, stoves, or other apparatus (including amplifiers) that produce heat.

- Do not defeat the safety purpose of the polarized or grounding-type plug. A polarized plug has two blades with one wider than the other. A grounding type plug has two blades and a third grounding prong. The wide blade or the third prong are provided for your safety. If the provided plug does not fit into your outlet, consult an electrician for replacement of the obsolete outlet (Can differ by country).

- Do not press strongly upon the panel with a hand or a sharp object such as a nail, pencil or pen, or make a scratch on it.

**WARNING:** This product contains chemicals known to the State of California to cause cancer and birth defects or other reproductive harm.

*Wash hands after handling.*

- Protect the power cord from being walked on or pinched particularly at plugs, convenience receptacles, and the point where they exit from the apparatus.



- Only use attachments/accessories specified by the manufacturer.



- Use only with a cart, stand, tripod, bracket, or table specified by the manufacturer, or sold with the apparatus. When a cart is used, use caution when moving the cart/apparatus combination to avoid injury from tip-over.



- Unplug this apparatus during lightning storms or when unused for long periods of time.

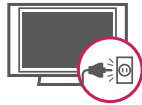

- Refer all servicing to qualified service personnel. Servicing is required when the apparatus has been damaged in any way, such as power-supply cord or plug is damaged, liquid has been spilled or objects have fallen into the apparatus, the apparatus has been exposed to rain or moisture, does not operate normally, or has been dropped.



- Do not stick metal objects or any other conductive material into the power cord. Do not touch the end of the power cord while it is plugged in.
- Keep the packing anti-moisture material or vinyl packing out of the reach of children. Anti-moisture material is harmful if swallowed. If swallowed by mistake, force the patient to vomit and visit the nearest hospital. Additionally, vinyl packing can cause suffocation. Keep it out of the reach of children.

- **CAUTION** concerning the Power Cord (Can differ by country):  
It is recommended that appliances be placed upon a dedicated circuit; that is, a single outlet circuit which powers only that appliance and has no additional outlets or branch circuits. Check the specification page of this owner's manual to be certain. Do not connect too many appliances to the same AC power outlet as this could result in fire or electric shock. Do not overload wall outlets. Overloaded wall outlets, loose or damaged wall outlets, extension cords, frayed power cords, or damaged or cracked wire insulation are dangerous. Any of these conditions could result in electric shock or fire. Periodically examine the cord of your appliance, and if its appearance indicates damage or deterioration, unplug it, discontinue use of the appliance, and have the cord replaced with an exact replacement part by an authorized service. Protect the power cord from physical or mechanical abuse, such as being twisted, kinked, pinched, closed in a door, or walked upon. Pay particular attention to plugs, wall outlets, and the point where the cord exits the appliance. Do not move the TV with the power cord plugged in. Do not use a damaged or loose power cord. Be sure do grasp the plug when unplugging the power cord. Do not pull on the power cord to unplug the TV.



- **Warning** - To reduce the risk of fire or electrical shock, do not expose this product to rain, moisture or other liquids. Do not touch the TV with wet hands. Do not install this product near flammable objects such as gasoline or candles, or expose the TV to direct air conditioning.



- Do not expose to dripping or splashing and do not place objects filled with liquids, such as vases, cups, etc. on or over the apparatus (e.g. on shelves above the unit).



- **Grounding**

(Except for devices which are not grounded.)

Ensure that you connect the earth ground wire to prevent possible electric shock (i.e. a TV with a three-prong grounded AC plug must be connected to a three-prong grounded AC outlet). If grounding methods are not possible, have a qualified electrician install a separate circuit breaker. Do not try to ground the unit by connecting it to telephone wires, lightning rods, or gas pipes.

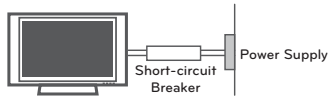

- As long as this unit is connected to the AC wall outlet, it is not disconnected from the AC power source even if the unit is turned off.
- Do not attempt to modify this product in any way without written authorization from LG Electronics. Unauthorized modification could void the user's authority to operate this product.
- **Outdoor Antenna Grounding**  
(Can differ by country):  
If an outdoor antenna is installed, follow the precautions below. An outdoor antenna system should not be located in the vicinity of overhead power lines or other electric light or power circuits, or where it can come in contact with such power lines or circuits as death or serious injury can occur. Be sure the antenna system is grounded so as to provide some protection against voltage surges and built-up static charges. Section 810 of the National Electrical Code (NEC) in the U.S.A. provides information with respect to proper grounding of the mast and supporting structure, grounding of the lead-in wire to an antenna discharge unit, size of grounding conductors, location of antenna discharge unit, connection to grounding electrodes and requirements for the grounding electrode.

**Antenna grounding according to the National Electrical Code, ANSI/NFPA 70**

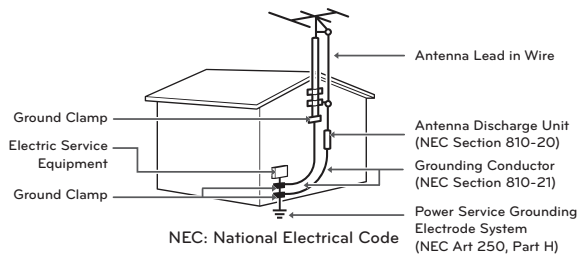

- **Cleaning**

When cleaning, unplug the power cord and wipe gently with a soft cloth to prevent scratching. Do not spray water or other liquids directly on the TV as electric shock may occur. Do not clean with chemicals such as alcohol, thinners or benzene.

- **Moving**

Make sure the product is turned off, unplugged and all cables have been removed. It may take 2 or more people to carry larger TVs. Do not press or put stress on the front panel of the TV.

- **Ventilation**

Install your TV where there is proper ventilation. Do not install in a confined space such as a bookcase. Do not cover the product with cloth or other materials while plugged. Do not install in excessively dusty places.

- If you smell smoke or other odors coming from the TV, unplug the power cord and contact an authorized service center.
- Keep the product away from direct sunlight.
- Never touch this apparatus or antenna during a thunder or lightning storm.
- When mounting a TV on the wall, make sure not to install the TV by hanging the power and signal cables on the back of the TV.
- Do not allow an impact shock or any objects to fall into the product, and do not drop anything onto the screen.
- **Disconnecting the Main Power**  
The power outlet used with this device must remain easily accessible.
- Store the accessories (battery, etc.) in a safe location out of the reach of children.
- This apparatus use batteries. In your community there might be regulations that require you to dispose of these batteries properly due to environmental considerations. Please contact your local authorities for disposal or recycling information.
- Do not dispose of batteries in a fire.
- Do not short circuit, disassemble or allow the batteries to overheat.

**• Dot Defect**

The Plasma or LCD panel is a high technology product with resolution of two million to six million pixels. In a very few cases, you could see fine dots on the screen while you're viewing the TV. Those dots are deactivated pixels and do not affect the performance and reliability of the TV.

**• Generated Sound**

**"Cracking" noise:** A cracking noise that occurs when watching or turning off the TV is generated by plastic thermal contraction due to temperature and humidity. This noise is common for products where thermal deformation is required.

**Electrical circuit humming/panel buzzing:** A low level noise is generated from a high-speed switching circuit, which supplies a large amount of current to operate a product. It varies depending on the product.

This generated sound does not affect the performance and reliability of the product.

- Take care not to touch the ventilation openings. When watching the TV for a long period, the ventilation openings may become hot. This does not affect the performance of the product or cause defects in the product.
- If the TV feels cold to the touch, there may be a small "flicker" when it is turned on. This is normal, there is nothing wrong with TV. Some minute dot defects may be visible on the screen, appearing as tiny red, green, or blue spots. However, they have no adverse effect on the TV's performance. Avoid touching the LCD screen or holding your finger(s) against it for long periods of time. Doing so may produce some temporary distortion effects on the screen.

**Preventing "Image burn" or "Burn-in" on your TV screen**

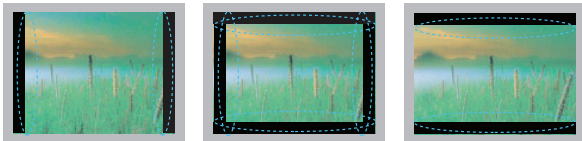

- If a fixed image displays on the TV screen for a long period of time, it will be imprinted and become a permanent disfigurement on the screen. This is "image burn" or "burn-in" and not covered by the warranty.
- If the aspect ratio of the TV is set to 4:3 for a long period of time, image burn may occur on the letterboxed area of the screen.
- Avoid displaying a fixed image on the TV screen for a long period of time (2 or more hours for LCD, 1 or more hours for the Plasma TV) to prevent image burn.

**For USA and Canada**

**FCC NOTICE**

This equipment has been tested and found to comply with the limits for a Class B digital device, pursuant to Part 15 of the FCC Rules. These limits are designed to provide reasonable protection against harmful interference in a residential installation. This equipment generates, uses and can radiate radio frequency energy and, if not installed and used in accordance with the instructions, may cause harmful interference to radio communications. However, there is no guarantee that interference will not occur in a particular installation. If this equipment does cause harmful interference to radio or television reception, which can be determined by turning the equipment off and on, the user is encouraged to try to correct the interference by one or more of the following measures:

- Reorient or relocate the receiving antenna.
- Increase the separation between the equipment and the receiver.
- Connect the equipment to an outlet on a circuit different from that to which the receiver is connected.
- Consult the dealer or an experienced radio/TV technician for help.

This device complies with part 15 of the FCC Rules. Operation is subject to the following two conditions: (1) this device may not cause harmful interference and (2) this device must accept any interference received, including interference that may cause undesired operation of the device.

Any changes or modifications in construction of this device which are not expressly approved by the party responsible for compliance could void the user's authority to operate the equipment.

**NOTE TO CABLE/TV INSTALLER**

This reminder is provided to call the CATV system installer's attention to Article 820-40 of the National Electric Code (U.S.A.). The code provides guidelines for proper grounding and, in particular, specifies that the cable ground shall be connected to the grounding system of the building, as close to the point of the cable entry as practical.

## Viewing 3D Imaging

### WARNING

#### Viewing Environment

- Viewing Time
  - When watching 3D content, take 5 - 15 minute breaks every hour. Viewing 3D content for a long period of time may cause headache, dizziness, fatigue or eye strain.

#### Those that have a photosensitive seizure or chronic illness

- Some users may experience a seizure or other abnormal symptoms when they are exposed to a flashing light or particular pattern from 3D content.
- Do not watch 3D videos if you feel nauseous, are pregnant and/ or have a chronic illness such as epilepsy, cardiac disorder, or blood pressure disease, etc.
- 3D Content is not recommended for those who suffer from stereo blindness or stereo anomaly. Double images or discomfort in viewing may be experienced.
- If you have strabismus (cross-eyed), amblyopia (weak eyesight) or astigmatism, you may have trouble sensing depth and easily feel fatigue due to double images. It is advised to take frequent breaks than the average adult.
- If your eyesight varies between your right and left eye, revise your eyesight prior to watching 3D content.

#### Symptoms which require discontinuation or refraining from watching 3D content

- Do not watch 3D content when you feel fatigue from lack of sleep, overwork or intoxication.
- When these symptoms are experienced, stop using/ watching 3D content and get enough rest until the symptom subsides.
  - Consult your doctor when the symptoms persist. Symptoms may include headache, eyeball pain, dizziness, nausea, palpitation, blurriness, discomfort, double image, visual inconvenience or fatigue.

### CAUTION

#### Viewing Environment

- Viewing Distance
  - Maintain a distance of at least twice the screen diagonal length when watching 3D content. If you feel discomfort in viewing 3D content, move further away from the TV.

#### Viewing Age

- Infants / Children
  - Usage/ Viewing 3D content for children under the age of 5 are prohibited.
  - Children under the age of 10 may overreact and become overly excited because their vision is in development (for example: trying to touch the screen or trying to jump into it. Special monitoring and extra attention is required for children watching 3D content.
  - Children have greater binocular disparity of 3D presentations than adults because the distance between the eyes is shorter than one of adults. Therefore they will perceive more stereoscopic depth compared to adults for the same 3D image.
- Teenagers
  - Teenagers under the age of 19 may be stimulated to light coming from 3D videos. Advise them not to watch 3D videos for a long time when they are tired.
- Elderly
  - The elderly may perceive less of a 3D effect than the youth. Do not sit closer to the TV than the recommended distance.

#### Cautions when using the 3D glasses

- Only use LG 3D glasses. Otherwise, you may not be able to view 3D videos properly.
- Do not use 3D glasses instead of your normal glasses, sunglasses or protective goggles.
- Using modified 3D glasses may cause eye strain or image distortion.
- Do not keep your 3D glasses in extremely high or low temperatures. It will cause deformation.
- The 3D glasses are fragile and are easy to scratched. Use a soft, clean piece of cloth when wiping the lenses. Do not scratch the lenses of the 3D glasses with sharp objects or clean/wipe them with chemicals.

## LICENSES

Supported licenses may differ by model. For more information about licenses, visit 'www.lg.com'.



Manufactured under license from Dolby Laboratories. "Dolby" and the double-D symbol are trademarks of Dolby Laboratories.



The terms HDMI and HDMI High-Definition Multimedia Interface, and the HDMI logo are trademarks or registered trademarks of HDMI Licensing LLC in the United States and other countries.



ABOUT DIVX VIDEO: DivX<sup>®</sup> is a digital video format created by DivX, LLC, a subsidiary of Rovi Corporation. This is an official DivX Certified<sup>®</sup> device that plays DivX video. Visit [divx.com](http://divx.com) for more information and software tools to convert your files into DivX video.

ABOUT DIVX VIDEO-ON-DEMAND: This DivX Certified<sup>®</sup> device must be registered in order to play purchased DivX Video-on-Demand (VOD) movies. To obtain your registration code, locate the DivX VOD section in your device setup menu. Go to [vod.divx.com](http://vod.divx.com) for more information on how to complete your registration.

"DivX Certified<sup>®</sup> to play DivX<sup>®</sup> video up to HD 1080p, including premium content."

"DivX<sup>®</sup>, DivX Certified<sup>®</sup> and associated logos are trademarks of Rovi Corporation or its subsidiaries and are used under license."

"Covered by one or more of the following U.S. patents:  
7,295,673; 7,460,668; 7,515,710; 7,519,274"



Manufactured under license under U.S. Patent Nos: 5,956,674; 5,974,380; 6,487,535 & other U.S. and worldwide patents issued & pending. DTS, the Symbol & DTS and the Symbol together are registered trademarks & DTS 2.0+Digital Out is a trademark of DTS, Inc. Product includes software. © DTS, Inc. All Rights Reserved.

ENGLISH

## OPEN SOURCE SOFTWARE NOTICE

To obtain the source code under GPL, LGPL, MPL and other open source licenses, that is contained in this product, please visit 'http://opensource.lge.com'.

In addition to the source code, all referred license terms, warranty disclaimers and copyright notices are available for download.

LG Electronics will also provide open source code to you on CD-ROM for a charge covering the cost of performing such distribution (such as the cost of media, shipping and handling) upon email request to 'opensource@lge.com'. This offer is valid for three (3) years from the date on which you purchased the product.



# TABLE OF CONTENTS

## 2 IMPORTANT SAFETY INSTRUCTIONS

6 Viewing 3D Imaging

## 7 LICENSES

## 7 OPEN SOURCE SOFTWARE NOTICE

## 8 TABLE OF CONTENTS

## 9 INSTALLATION PROCEDURE

## 9 ASSEMBLING AND PREPARING

9 Unpacking  
 11 Optional Extras  
 12 Parts and Buttons  
 13 Lifting and moving the TV  
 14 Setting up the TV  
 14 - Attaching the stand  
 15 - Mounting on a table  
 16 - Tidying cables  
 17 - Mounting on a wall

## 18 MAKING CONNECTIONS

18 Connecting to an antenna or cable  
 19 Connecting to a HD receiver, DVD Player or VCR  
 19 - HDMI Connection  
 20 - DVI to HDMI Connection  
 21 - Connecting to a mobile phone  
 22 - Component Connection  
 23 - Composite Connection  
 24 Connecting a PC  
 24 - HDMI Connection DVI to HDMI Connection  
 26 Connecting to an Audio System  
 26 - Digital Optical Audio Connection  
 27 Connecting Headphones  
 27 Connecting a USB Device

## 28 MAGIC REMOTE CONTROL FUNCTIONS

29 Registering Magic Remote Control  
 29 How to use Magic Remote Control  
 29 Precautions to Take when Using the Magic Remote Control

## 30 WATCHING TV

30 Turning the TV on for the first time

## 31 USING THE USER GUIDE

## 32 SPECIFICATIONS

## 36 EXTERNAL CONTROL DEVICE SETUP

## 37 MAINTENANCE

37 Cleaning Your TV  
 37 - Screen, frame, cabinet and stand  
 37 - Power cord

## 37 TROUBLESHOOTING

### ! NOTE

- Image shown may differ from your TV.
- Your TV's OSD (On Screen Display) may differ slightly from that shown in this manual.
- The available menus and options may differ from the input source or product model that you are using.
- New features may be added to this TV in the future.



## INSTALLATION PROCEDURE

- 1 Open the package and make sure all the accessories are included.
- 2 Attach the stand to the TV set.
- 3 Connect an external device to the TV set.
- 4 Make sure the network connection is available.  
You can use the TV network functions only when the network connection is made.

## ASSEMBLING AND PREPARING

### Unpacking

Check your product box for the following items. If there are any missing accessories, contact the local dealer where you purchased your product. The illustrations in this manual may differ from the actual product and item.

#### CAUTION

- Do not use any unapproved items to ensure the safety and product life span.
- Any damages or injuries by using unapproved items are not covered by the warranty.
- Some models appear to have a thin film on the screen. It is actually part of the screen, do not remove it.

#### NOTE

- The items supplied with your product may vary depending on the model.
- Product specifications or contents of this manual may be changed without prior notice due to upgrade of product functions.
- For an optimal connection, HDMI cables and USB devices should have bezels less than 10 mm (0.39 inches) thick and 18 mm (0.7 inches) width.
- Use an extension cable that supports USB 2.0 if the USB cable or USB memory stick does not fit into your TV's USB port.

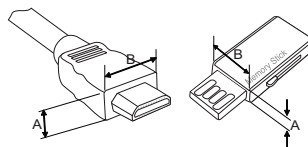

\*A ≤ 10 mm (0.39 inches)

\*B ≤ 18 mm (0.7 inches)

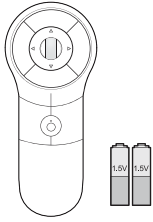

**Magic Remote Control,  
Batteries (AA)**  
(See p.28)

---

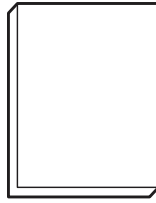

**Owner's Manual**

---

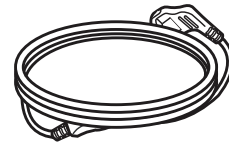

**Power Cord**

---



**Cinema 3D Glasses**  
The number of 3D glasses may differ depending on the model or country.

---



**Stand Screws**  
4 EA, M4 x 20  
(See p.14)

---



**Cable Holder**  
(See p.16)

---

ENGLISH

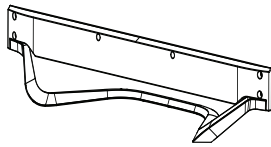

**Stand Base**  
(See p.14)

---



**Tag On**  
Near Field Communication (NFC)  
tag.

---

## Optional Extras

Optional extras can be changed or modified for quality improvement without any notification. Contact your dealer to buy these items.

These devices only work with certain models.

The model name or design may be changed manufacturer's circumstances or policies.

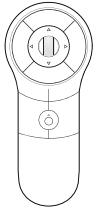

**AN-MR400**  
Magic Remote



**AG-F\*\*\***  
Cinema 3D Glasses. All glasses with the Cinema 3D logo support the TVs in this manual.



**AG-F\*\*DP**  
Dual Play Glasses. For playing head-to-head games. Converts most 2 player split-screen games to full screen.

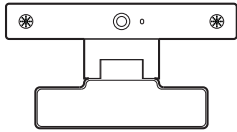

**AN-VC\*\*\***  
Video Call Camera



**Tag On**  
Near Field Communication (NFC) tag.

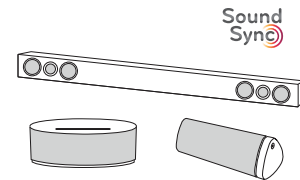

**LG Audio device**

## Parts and Buttons

For LA6900, LA6950 series, 47, 55LA7400

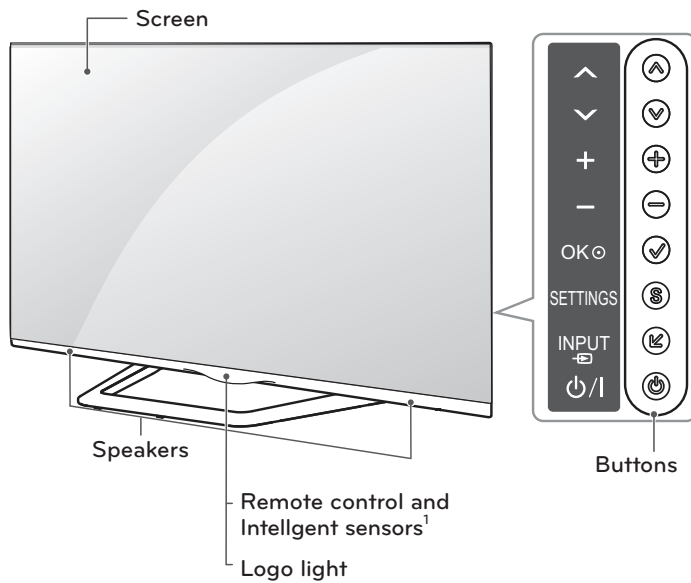

For 60LA7400

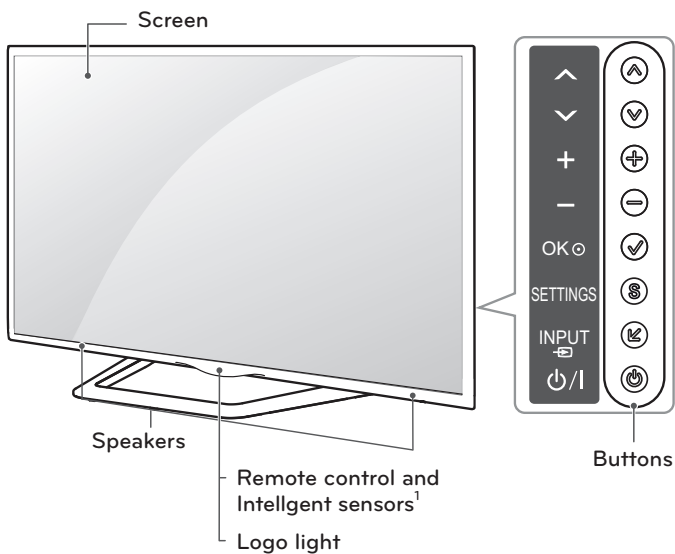

ENGLISH

Button	Description
▲/▼ (▲/▼)	Scrolls through the saved channels.
+/- (+/-)	Adjusts the volume level.
✓ (OK ●)	Selects the highlighted menu option or confirms an input.
S (SETTINGS)	Accesses the main menus, or saves your input and exits the menus.
I (INPUT)	Changes the input source.
⏻ (⏻/⏷)	Turns the power on or off.

1. Intelligent sensor - Adjusts the image quality and brightness based on the surrounding environment.

## Lifting and moving the TV

When moving or lifting the TV, read the following to prevent the TV from being scratched or damaged and for safe transportation regardless of its type and size.

### CAUTION

- Avoid touching the screen at all times, as this may result in damage to the screen.
- It is recommended to move the TV in the box or packing material that the TV originally came in.
- Before moving or lifting the TV, disconnect the power cord and all cables.
- When holding the TV, the screen should face away from you to avoid damage.



- Hold the top and bottom of the TV frame firmly. Make sure not to hold the transparent part, speaker, or speaker grill area.

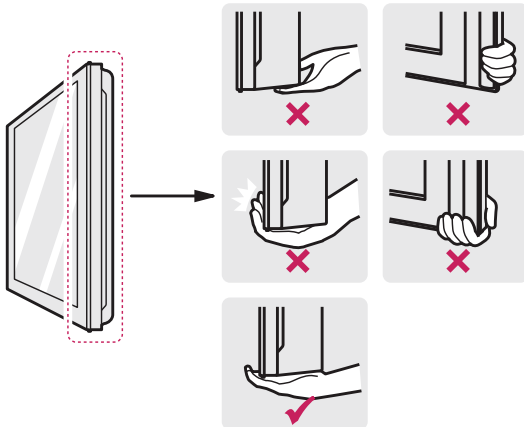

- When transporting a large TV, there should be at least 2 people.
- When transporting the TV by hand, hold the TV as shown in the following illustration.

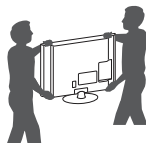

- When transporting the TV, do not expose the TV to jolts or excessive vibration.
- When transporting the TV, keep the TV upright, never turn the TV on its side or tilt towards the left or right.

## Setting up the TV

You can mount your TV to a wall or attach the stand if you wish to place the TV on an entertainment center or other furniture.

### Attaching the stand

If you are not mounting the TV to a wall, use the following instructions to attach the stand.

#### ⚠ CAUTION

- When attaching the stand to the TV set, place the screen facing down on a cushioned table or flat surface to protect the screen from scratches.
- Make sure that the screws are fastened tightly. (If they are not fastened securely enough, the TV may tilt forward after being installed.)
- Do not tighten the screws with too much force; otherwise they may be damaged and come loose later.

#### ⓘ NOTE

- Remove the stand before installing the TV on a wall mount by performing the stand attachment in reverse.

1

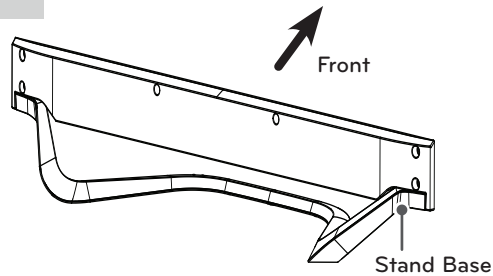

2

Wrapping bag  
(Depending on model)

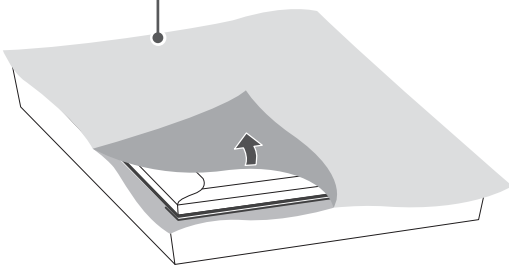

3

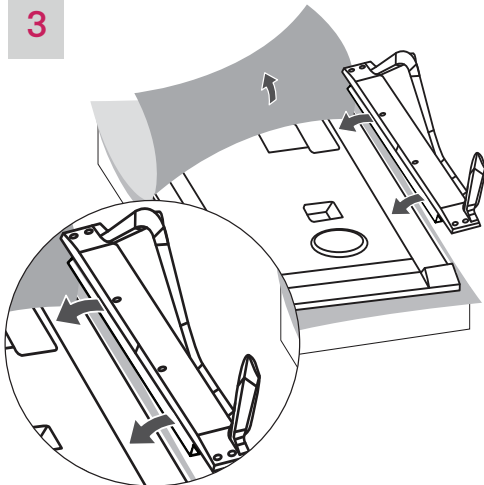

4

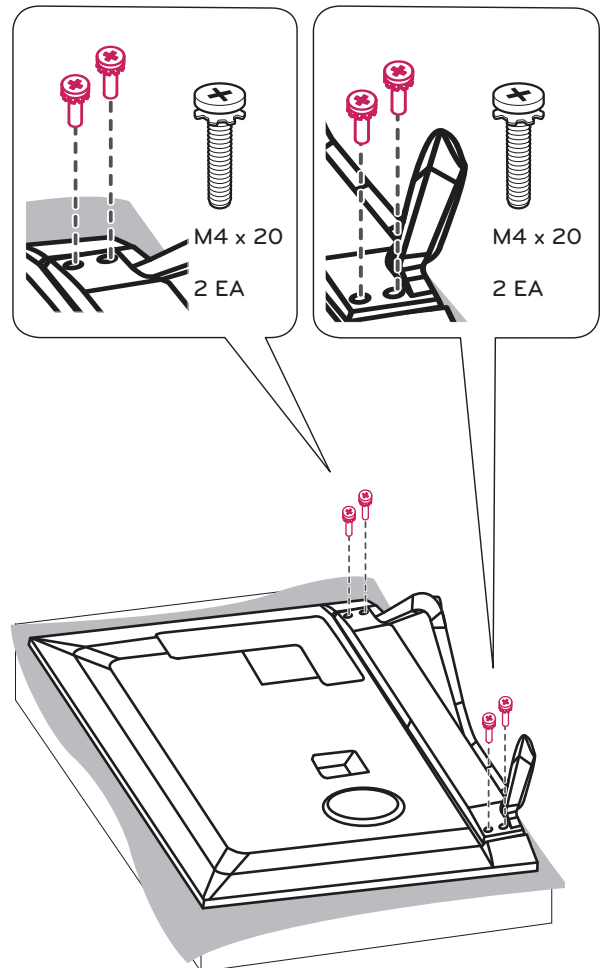

## Mounting on a table

- 1 Lift and tilt the TV into its upright position on a table.
  - Leave a 10 cm (minimum) space from the wall for proper ventilation.

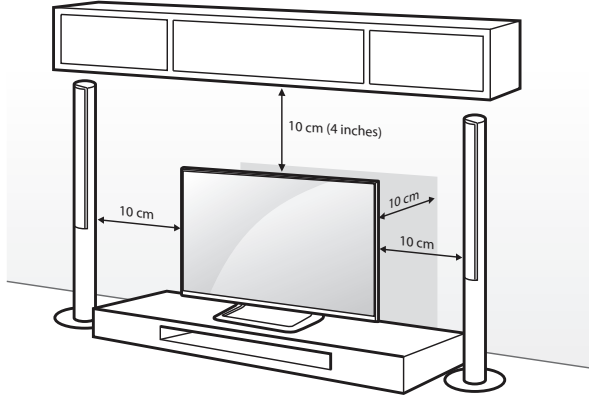

- 2 Connect the power cord to a wall outlet.

### ⚠ CAUTION

- Do not place the TV near or on sources of heat, as this may result in fire or other damage.

## Adjusting the angle of the TV to suit view

Swivel 10 degrees to the left or right and adjust the angle of the TV to suit your view.  
(For 47LA6900, 47LA7400)

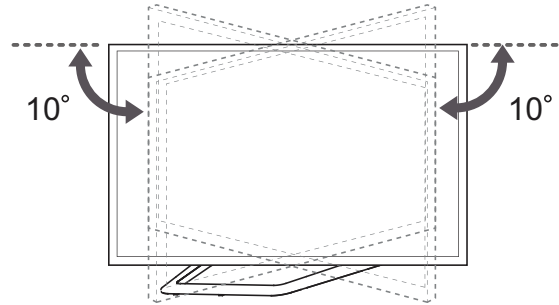

Swivel 8 degrees to the left or right and adjust the angle of the TV to suit your view.  
(For 55LA6900, 55LA6950, 55LA7400, 60LA7400)

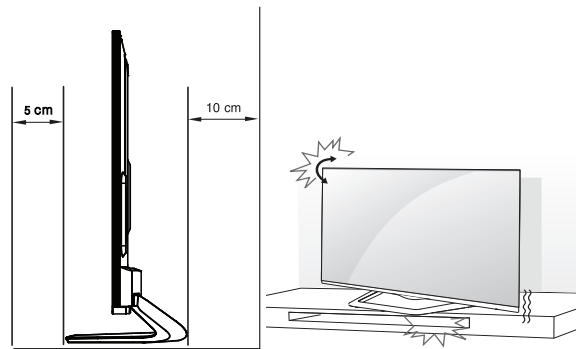
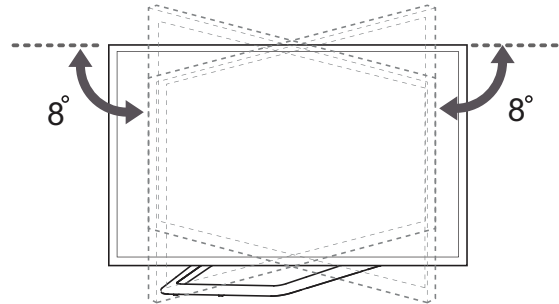

### ⚠ CAUTION

- Install the product on a flat surface for easy swivel. Make sure to use the TV cabinet or stand that can properly support the TV.
- After installing the TV, the angle of the screen can be adjusted to the left or right.
- When adjusting the angle, make sure there are no objects near the TV and the TV has enough distance from the wall. A space of at least 5 cm on the front and 10 cm on the back should be available. Otherwise, the product could fall due to balance problems, which may cause personal injury or damage to the product.



**Securing the TV to a wall (optional)**

(Depending on model)

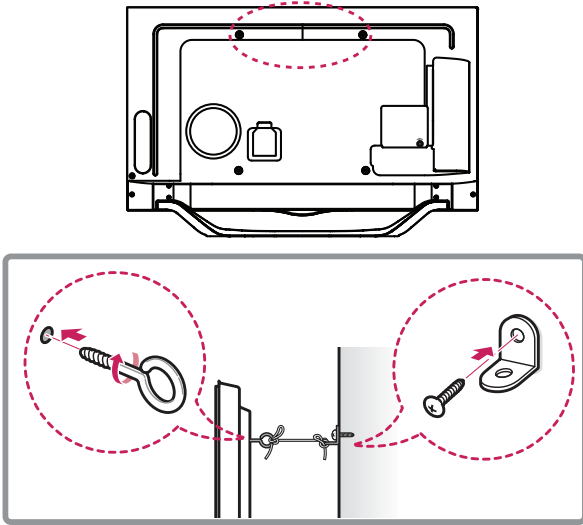

- 1 Insert and tighten the eye-bolts, or TV brackets and bolts on the back of the TV.  
- If there are bolts inserted at the eye-bolts position, remove the bolts first.
- 2 Mount the wall brackets with the bolts to the wall. Match the location of the wall bracket and the eye-bolts on the rear of the TV.
- 3 Connect the eye-bolts and wall brackets tightly with a sturdy rope. Make sure to keep the rope horizontal with the flat surface.

**CAUTION**

- Make sure that children do not climb on or hang on the TV.

**NOTE**

- Use a platform or cabinet that is strong and large enough to support the TV securely.
- Brackets, bolts and ropes are optional. You can obtain additional accessories from your local dealer.

**Tidying cables**

- 1 Gather and bind the cables with the cable holder on the back of the TV.

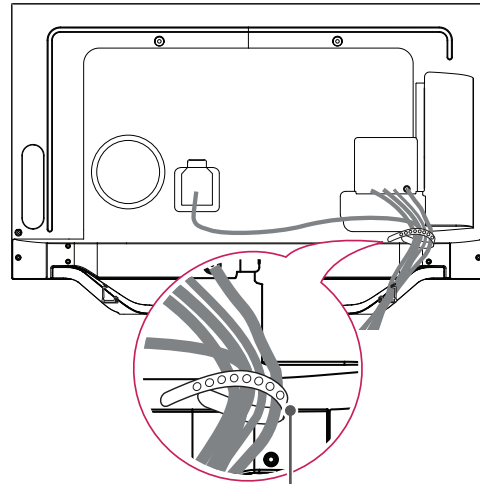

Cable Holder

- 2 Gather and bind the cables with the cable management clip.

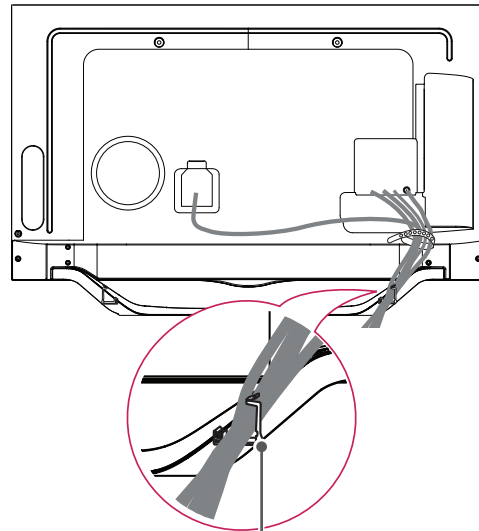

Cable Management Clip

**CAUTION**

- Do not move the TV by holding the cable holder and cable management clip, as the cable holders may break, and injuries and damage to the TV may occur.

### Mounting on a wall

An optional wall mount can be used with your LG Television. Consult with your local dealer for a wall mount that supports the VESA standard used by your TV model. Carefully attach the wall mount bracket at the rear of the TV. Install the wall mount bracket on a solid wall perpendicular to the floor. If you are attaching the TV to other building materials, please contact qualified personnel to install the wall mount. Detailed instructions will be included with the wall mount. We recommend that you use an LG brand wall mount.

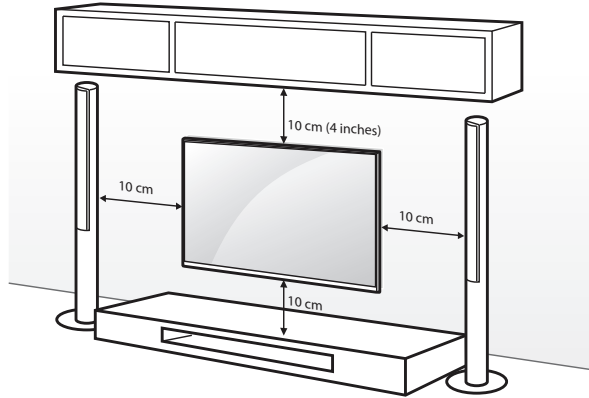

Make sure to use screws and wall mounts that meet the VESA standard. Standard dimensions for the wall mount kits are described in the following table.

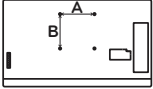
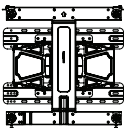
<b>Model</b>	47/55LA6900 47/55LA6950 47/55/60LA7400
<b>VESA (A x B)</b> 	400 x 400
<b>Standard screw</b>	M6
<b>Number of screws</b>	4
<b>Wall mount bracket (optional)</b>	LSW430B 

#### CAUTION

- Disconnect the power before moving or installing the TV. Otherwise electric shock may occur.
- If you install the TV on a ceiling or slanted wall, it may fall and result in severe injury. Use an authorized LG wall mount and contact the local dealer or qualified personnel.
- Do not over tighten the screws as this may cause damage to the TV and void your warranty.
- Use the screws and wall mounts that meet the VESA standard. Any damages or injuries by misuse or using an improper accessory are not covered by the warranty.

#### NOTE

- Use the screws that are listed in the VESA standard screw specifications.
- The wall mount kit includes an installation manual and necessary parts.
- The wall mount bracket is optional. You can obtain additional accessories from your local dealer.
- The length of screws may differ depending on the wall mount. Make sure to use the proper length.
- For more information, refer to the manual supplied with the wall mount.

## MAKING CONNECTIONS

You can connect various external devices to the TV. Supported external devices are: HD receivers, DVD players, VCRs, audio systems, USB storage devices, PC, gaming devices, and other external devices. For more information on external device's connection, refer to the manual provided with each device.

### ! NOTE

- If you record a TV program on a DVD recorder or VCR, make sure to connect the TV signal input cable to the TV through a DVD recorder or VCR. For more information of recording, refer to the manual provided with the connected device.
- The external device connections shown may differ slightly from illustrations in this manual.
- Connect external devices to the TV regardless of the order of the TV port.
- If you connect a gaming device to the TV, use the cable supplied with the gaming device.
- Refer to the external equipment's manual for operating instructions.

### Connecting to an antenna or cable

Connect an antenna, cable, or cable box to watch TV while referring to the following. The illustrations may differ from the actual items and a RF cable is optional.

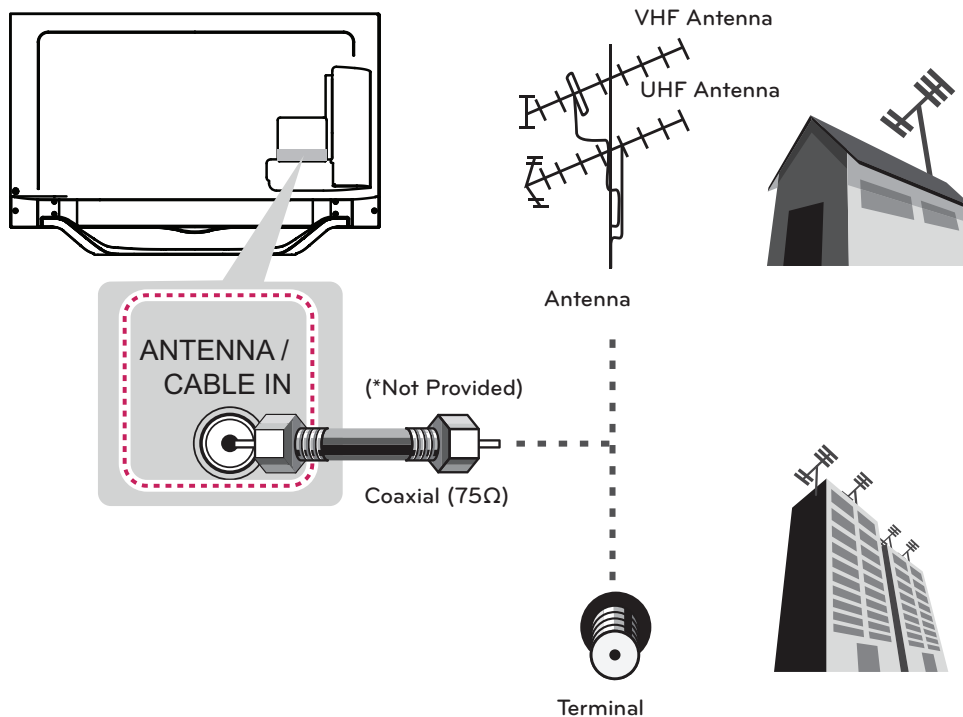

### ! CAUTION

- Make sure not to bend the copper wire of the RF cable.

Copper wire

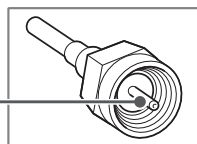

- Complete all connections between devices, and then connect the power cord to the power outlet to prevent damage to your TV.

### ! NOTE

- Use a signal splitter to use more than 2 TVs.
- Visit <http://lgknowledgebase.com> for more information about the antenna and cable connection. Search for antenna.
- DTV Audio Supported Codec: MPEG, Dolby Digital, DTS

## Connecting to a HD receiver, DVD Player or VCR

Connect a HD receiver, DVD Player, or VCR to the TV and select an appropriate input mode.

### HDMI Connection

**HDMI is the best way to connect a device.**

Transmits digital video and audio signals from an external device to the TV. Connect the external device and the TV with the HDMI cable as shown in the following illustration.

**NOTE**

- Use the latest High Speed HDMI™ Cable that supports CEC (Customer Electronics Control) function.
- High Speed HDMI™ Cables are tested to carry an HD signal up to 1080p and higher.
- HDMI Audio Supported Format: Dolby Digital, DTS, PCM (Up to 192 KHz, 32k/44.1k/48k/88k/96k/176k/192k).

Choose any HDMI input port to connect.  
It does not matter which port you use.

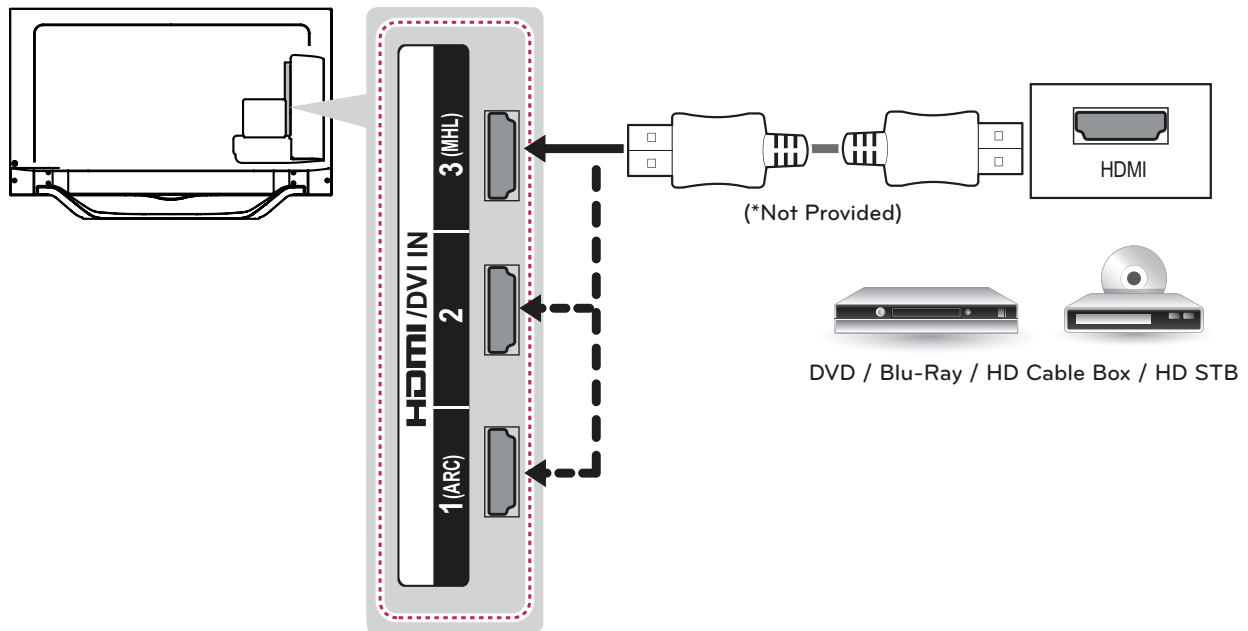

ENGLISH

#### ARC (Audio Return Channel)

- When connected with a high-speed HDMI cable, digital audio can be sent to a compatible device without an additional optical audio cable.
- ARC is only supported on the HDMI input 1 (ARC) port. An external audio device that supports ARC should be connected to HDMI 1 if you wish to use ARC.

### DVI to HDMI Connection

Transmits the digital video signal from an external device to the TV. Connect the external device and the TV with the DVI-HDMI cable as shown in the following illustration. To transmit an audio signal, connect an audio cable.

Choose any HDMI/DVI input port to connect.  
It does not matter which port you use.

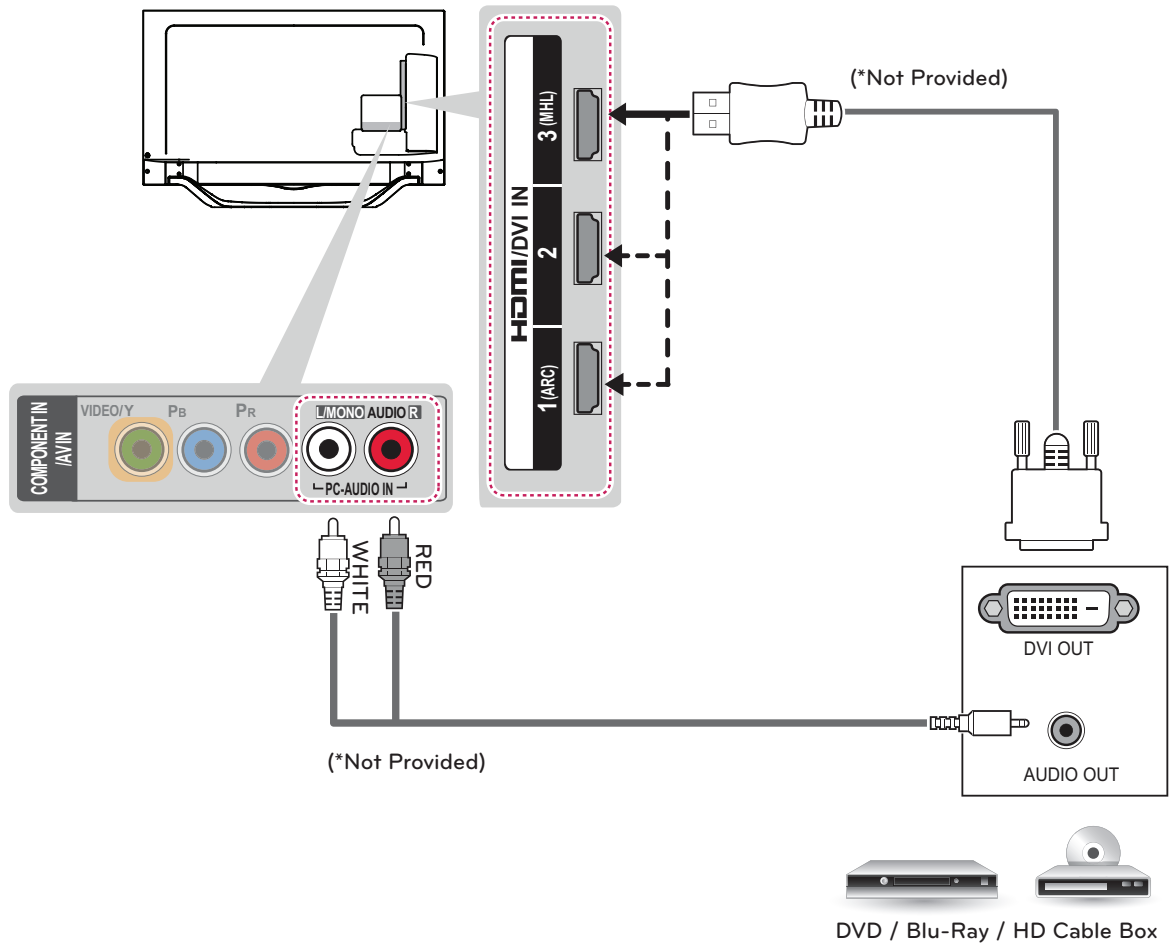

ENGLISH

## Connecting to a mobile phone

Mobile High-definition Link (MHL) is an interface for transmitting digital audio/visual signals from mobile phones to television sets.

### ! NOTE

- Connect the mobile phone to the HDMI IN 3 (MHL) port to view the phone screen on the TV.
- This only works with an MHL-enabled phone.
- With some MHL supporting mobile phones, you can use the TV remote to control the phone.
- An MHL passive cable is needed to connect the TV and a mobile phone.
- Remove the MHL cable from the TV when:
  - the MHL function is disabled
  - your mobile device is fully charged in standby mode

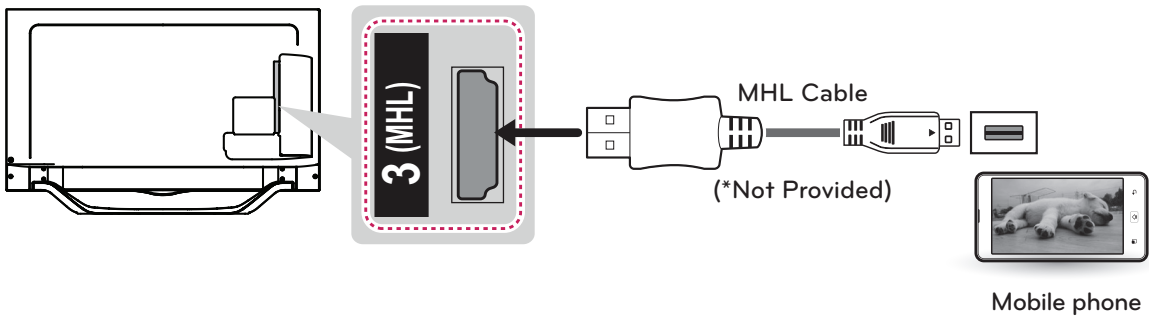

### Component Connection

Transmits analog video and audio signals from an external device to the TV. Connect the external device and the TV with a component cable as shown in the following illustration.

**NOTE**

- If cables are installed incorrectly, it could cause the image to display in black and white or with distorted color.
- Check to ensure the cables are matched with the corresponding color connection.

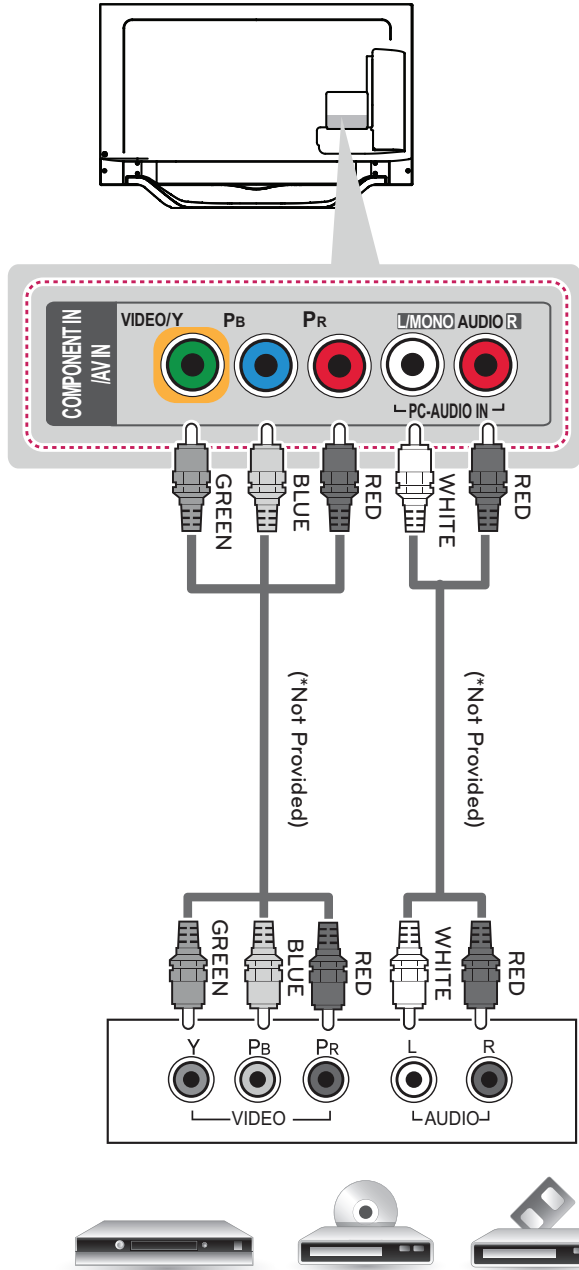

DVD / Blu-Ray / HD Cable Box / VCR

ENGLISH



### Composite Connection

Transmits analog video and audio signals from an external device to the TV. Connect the external device and the TV with the composite cable as shown in the following illustration.

**NOTE**

- Check to ensure the cables are matched with the corresponding color connection.

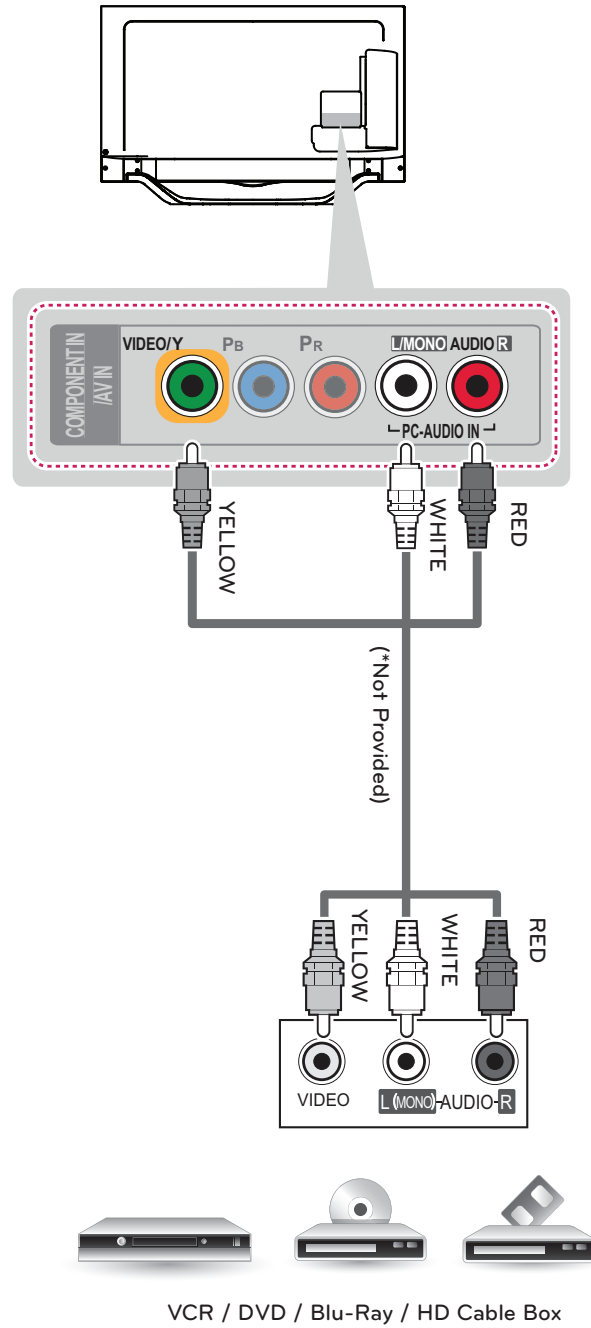

## Connecting a PC

### ! NOTE

- It is recommended to use an HDMI connection for the best image quality.
- Depending on the graphics card, DOS mode video may not work if a HDMI to DVI Cable is in use.
- In PC mode, there may be noise associated with the resolution, vertical pattern, contrast or brightness. If noise is present, change the PC output to another resolution, change the refresh rate to another rate or adjust the brightness and contrast on the PICTURE menu until the picture is clear.
- The synchronization input form for Horizontal and Vertical frequencies is separate.
- Depending on the graphics card, some resolution settings may not allow the image to be positioned on the screen properly.

### HDMI Connection DVI to HDMI Connection

Choose method A or B to make connection.

#### Method A: HDMI Connection

Choose any HDMI input port to connect.  
It does not matter which port you use.

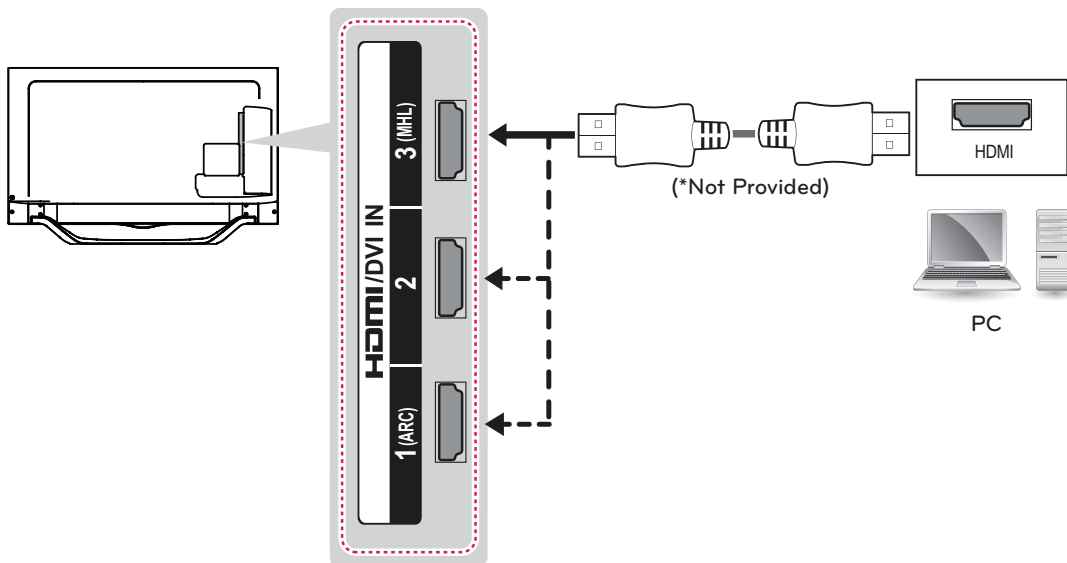

### Method B: DVI to HDMI Connection

Choose any HDMI/DVI input port to connect.  
It does not matter which port you use.

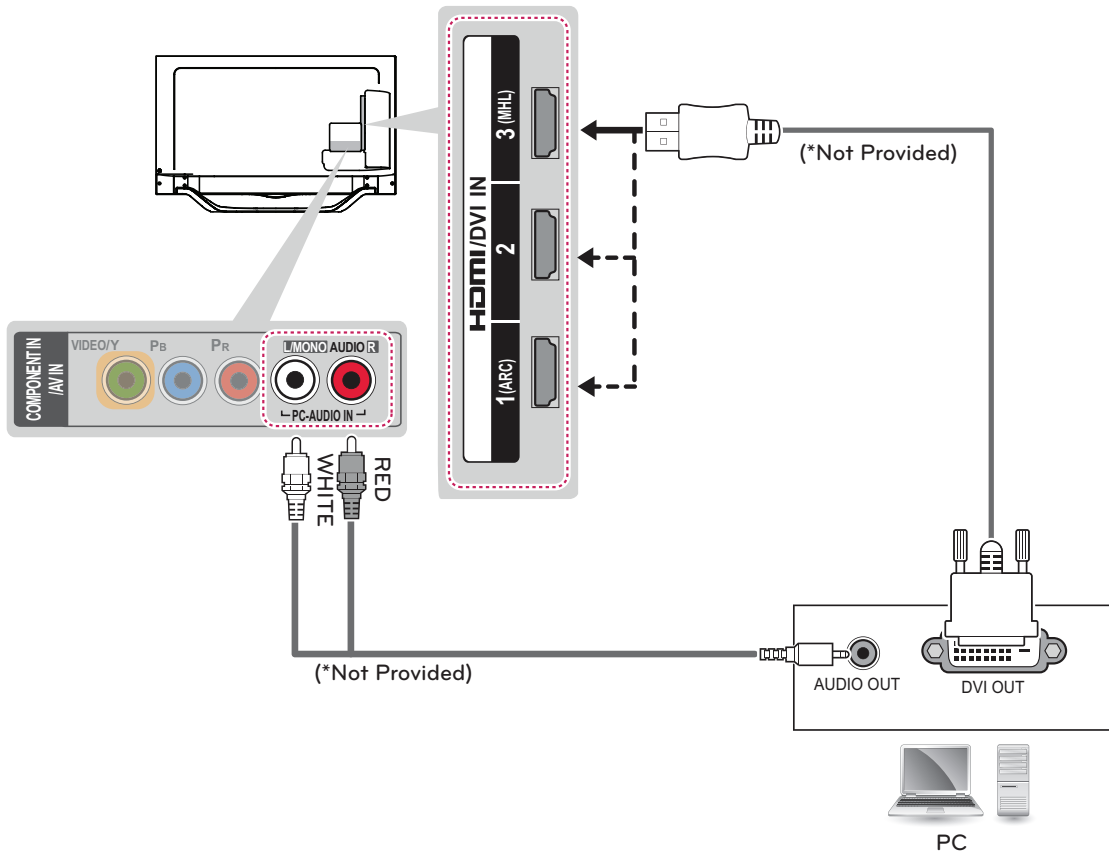

## Connecting to an Audio System

You can use an optional external audio system instead of the built-in speaker.

### Digital Optical Audio Connection

Transmits a digital audio signal from the TV to an external device. Connect the external device and the TV with the optical audio cable as shown in the following illustration.

#### ! NOTE

- Do not look into the optical output port. Looking at the laser beam may damage your vision.
- Audio with ACP (Audio Copy Protection) function may block digital audio output.

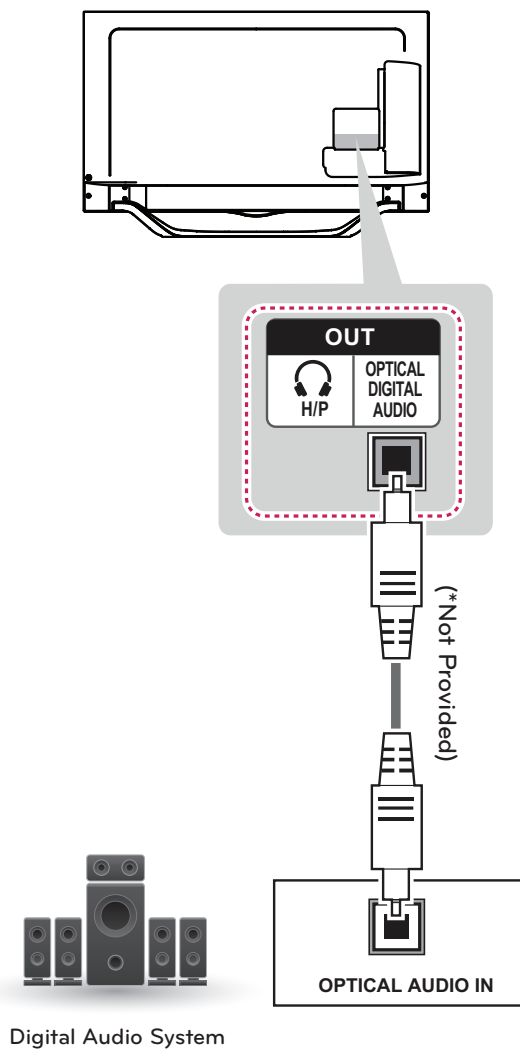

## Connecting Headphones

Listening to sound with headphones

**NOTE**

- AUDIO menu options are disabled when using headphones.
- When changing AV MODE with headphones connected, the change is applied to video but not to audio.
- Optical Digital Audio Out is not available when headphones are connected.
- Headphone impedance: 16 Ω
- Max audio output: 10 mW to 15 mW
- Headphone jack size: 0.35 cm (0.13 inches)

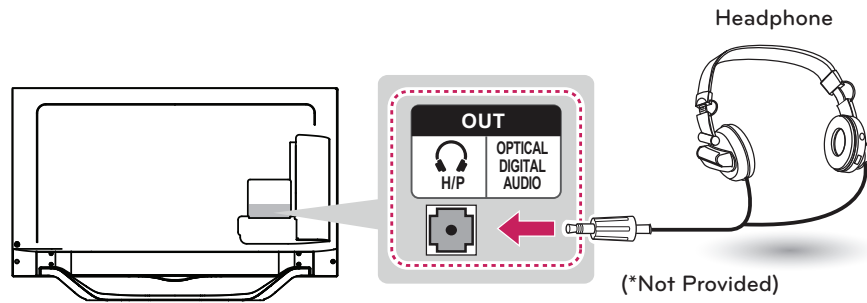

## Connecting a USB Device

Connect a USB storage device such as USB flash memory, external hard drive, or a USB memory card reader to the TV and access the Smart Share menu to use various multimedia files.

**NOTE**

- Some USB Hubs may not work. If a USB device connected using a USB Hub is not detected, connect it to the USB port on the TV directly.

Choose any USB input port to connect.  
It does not matter which port you use.

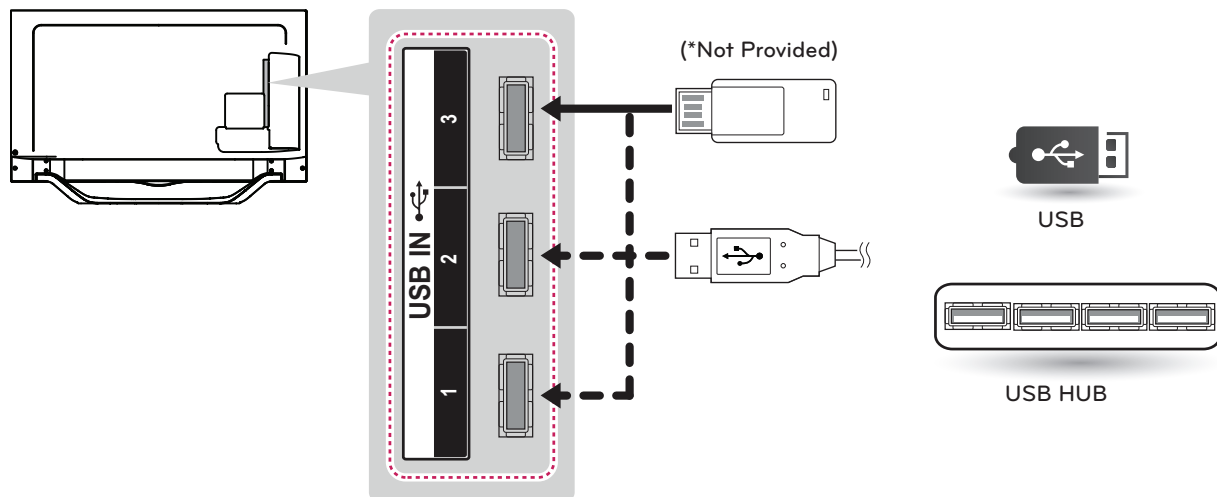

## MAGIC REMOTE CONTROL FUNCTIONS

When the message "Magic remote control battery is low. Change the battery." is displayed, replace the battery. To install batteries, open the battery cover, replace batteries (1.5 V AA) matching  $\oplus$  and  $\ominus$  ends to the label inside the compartment, and close the battery cover. Be sure to point the remote control at the remote control sensor on the TV. To remove the batteries, perform the installation actions in reverse.

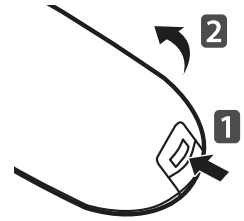

### CAUTION

- Do not mix old and new batteries, as this may damage the remote control.

This remote uses infrared light. When in use, it should be pointed in the direction of the TV's remote sensor.

ENGLISH

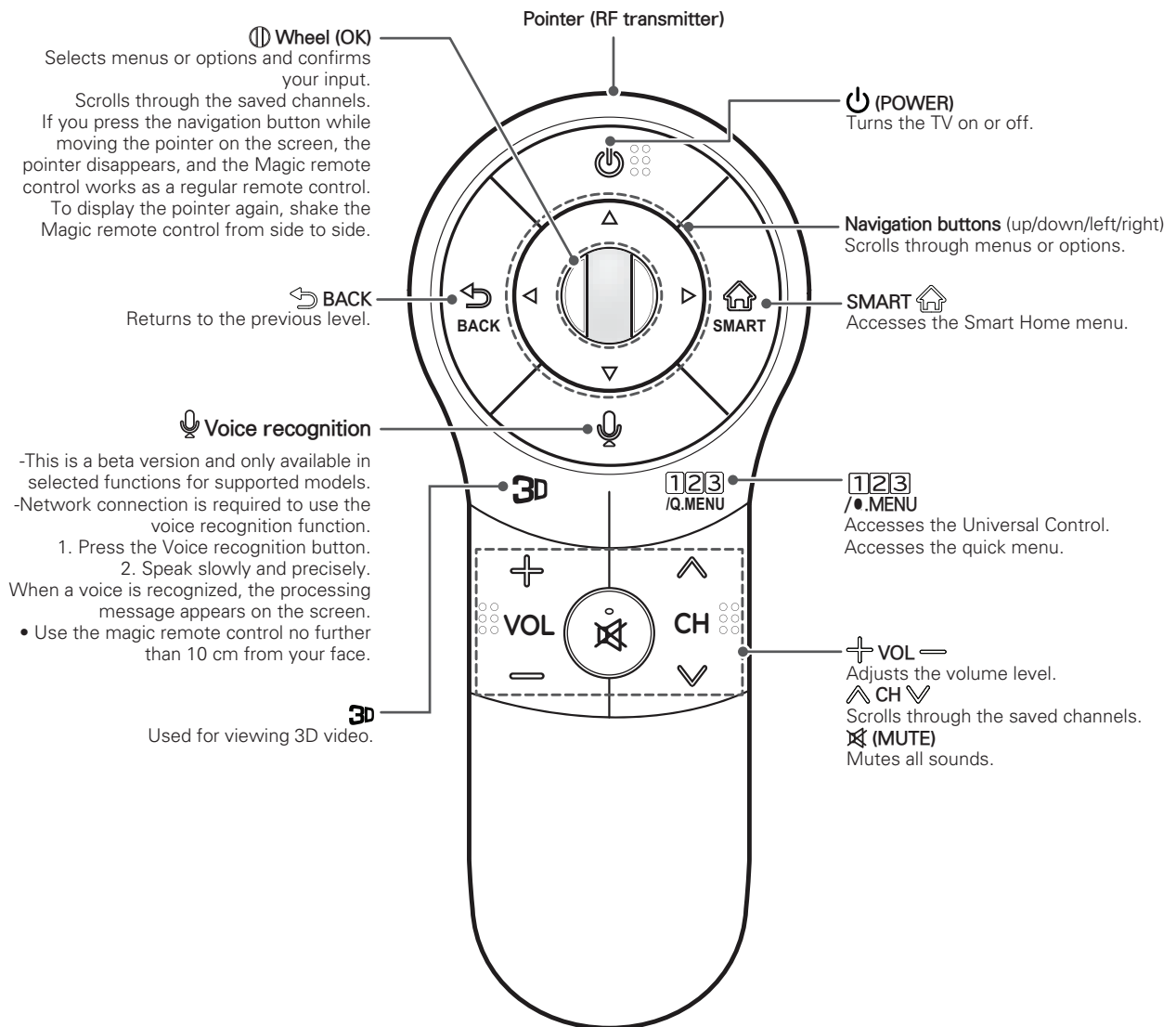

## Registering Magic Remote Control



The Magic Remote Control operates by pairing with your TV.

Please register the remote as follows.

### How to register the Magic Remote Control

 <b>(Wheel)</b>	<p>To register automatically, turn the TV on and press the <b>Wheel (OK)</b>. When registration is completed, the completion message appears on the screen.</p> <p>If registration fails, turn the TV off and back on, then press the <b>Wheel (OK)</b> to complete registration.</p>
---	---

### How to Re-register the Magic Remote Control

 <b>BACK</b>	<p>1 Press and hold the <b>BACK</b> and <b>SMART</b> buttons together for 5 seconds to reset, then register it by following "How to register the Magic remote control" above.</p> <p>2 To re-register the Magic remote control, press and hold the <b>BACK</b> button for 5 seconds toward the TV.</p>
 <b>HOME</b>	

## How to use Magic Remote Control

	<p>1 You can move the pointer by aiming the Pointer Receiver of the remote control at your TV then move it left, right, up or down.</p> <p>» If the pointer does not work properly leave the remote control for 10 seconds then use it again.</p> <p>2 If the pointer disappears, move the remote control slightly to left or right. Then, it will automatically appear on the screen.</p> <p>» If the pointer has not been used for a certain period of time, it will disappear.</p>
---	---

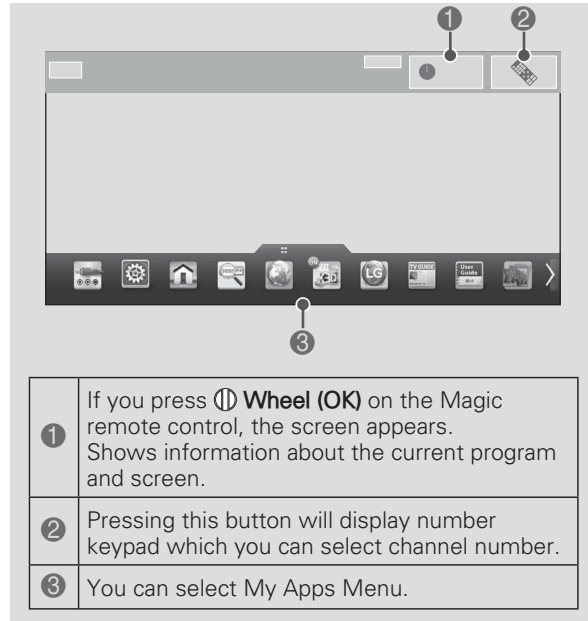

## Precautions to Take when Using the Magic Remote Control

- Use the Magic remote control within the maximum communication distance (10 m, 32.8ft). Using the remote control beyond this distance, or with an object obstructing it, may cause a communication failure.
- A communication failure may occur due to nearby devices. Electrical devices such as a microwave oven or wireless LAN product may cause interference, as these use the same bandwidth (2.4 GHz) as the Magic remote control.
- The Magic remote control may be damaged or may malfunction if it is dropped or receives a heavy impact.
- Take care not to bump into nearby furniture or other people when using the Magic remote control.
- Manufacturer and installer cannot provide service related to human safety as the applicable wireless device has possibility of electric wave interference.
- It is recommended that an Access Point (AP) be located more than 1 m (3.28 ft) away from the TV. If the AP is installed closer than 1 m (3.28 ft), the Magic remote control may not perform as expected due to frequency interference.



## WATCHING TV

### Turning the TV on for the first time

When you turn the TV on for the first time, the Initial setting screen appears. Select a language and customize the basic settings.

- 1 Connect the power cord to a power outlet.
- 2 In Standby mode, press the power button on the remote control to turn the TV on. The Initial setting screen appears if you turn the TV on for the first time.

#### ! NOTE

- You can also access **Initial Setting** by accessing **OPTION** in the main menu.

- 3 Follow the on-screen instructions to customize your TV settings according to your preferences.

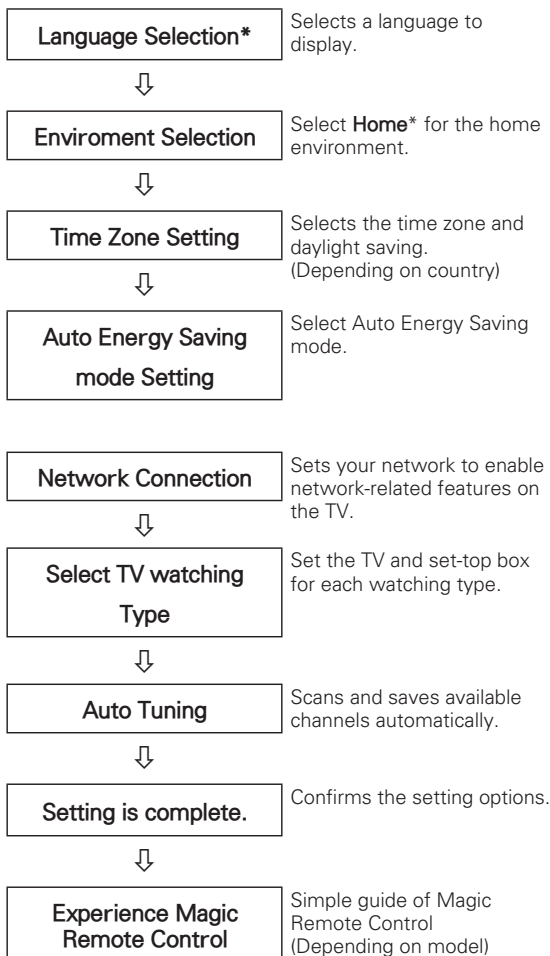

#### ! NOTE

- Select **Home\*** when prompted. **Store\*** mode puts the TV in demo mode.
- If you select **Store\***, the any customized settings will switch back to the default settings of **Store\*** in 5 minutes.
- The Standby light feature is disabled in Store Demo mode.

- 4 When the basic settings are complete, press the **Wheel (OK)**.



#### ! NOTE

- If you do not complete the Initial setting, it will appear whenever the TV turns on.
- Disconnect the power cord from the power outlet when you do not use the TV for a long period of time.



- 5 To turn the TV off, press the power button on the remote control.

# USING THE USER GUIDE

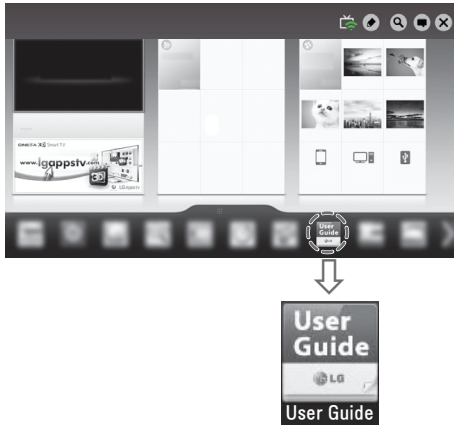

User Guide allows you to easily access detailed TV information.

- 1 Press **SMART**  button to access the Smart Home menus.
- 2 Select **User Guide** and press the  button.



1	Shows the description of the selected menu. You can use  /  to move between pages.
2	Moves to the selected menu directly from the User Guide.

(Depending on country)

1	Shows the video you were watching.
2	Guide categories.
3	List of topics in the current category. You can use  /  button to move between pages.
4	An index of key words present in the User Guide.
5	Provides the detailed information on the functions of LG Smart TV when the Internet is connected. (It may not be available depending on the country/language.)

## SPECIFICATIONS

Product specifications may be changed without prior notice due to upgrade of product functions.

<b>Power requirement</b>		AC 100 - 240 V ~ 50 / 60 Hz
<b>Television System</b>		NTSC-M, ATSC, 64 & 256 QAM
<b>Program Coverage</b>		VHF 2-13, UHF 14-69, CATV 1-135, DTV 2-69, CADTV 1-135
<b>External Antenna Impedance</b>		75 $\Omega$
<b>Environment condition</b>	Operating Temperature	0 - 40 °C
	Operating Humidity	Less than 80 %
	Storage Temperature	-20 - 60 °C
	Storage Humidity	Less than 85 %

MODELS		47LA6900 (47LA6900-UD)
		47LA6950 (47LA6950-UD)
Dimensions (W x H x D)	With stand	1,063 x 697 x 269 (mm)
		41.8 x 27.4 x 10.5 (inch)
	Without stand	1,063 x 627 x 34.5 (mm)
		41.8 x 24.6 x 1.3 (inch)
Weight	With stand	16.7 kg (36.8 lbs)
	Without stand	14.6 kg (32.1 lbs)
Current Value / Power consumption		1.2 A / 120 W

MODELS		55LA6900 (55LA6900-UD)
		55LA6950 (55LA6950-UD)
Dimensions (W x H x D)	With stand	1,233 x 793 x 316 (mm)
		48.5 x 31.2 x 12.4 (inch)
	Without stand	1,233 x 723 x 34.7 (mm)
		48.5 x 28.4 x 1.3 (inch)
Weight	With stand	22.8 kg (50.2 lbs)
	Without stand	20.0 kg (44.0 lbs)
Current Value / Power consumption		1.4 A / 140 W

MODELS		47LA7400 (47LA7400-UD)	55LA7400 (55LA7400-UD)
Dimensions (W x H x D)	With stand	1,063 x 697 x 269 (mm)	1,233 x 793 x 316 (mm)
		41.8 x 27.4 x 10.5 (inch)	48.5 x 31.2 x 12.4 (inch)
	Without stand	1,063 x 627 x 34.5 (mm)	1,233 x 723 x 34.7 (mm)
		41.8 x 24.6 x 1.3 (inch)	48.5 x 28.4 x 1.3 (inch)
Weight	With stand	16.7 kg (36.8 lbs)	22.8 kg (50.2 lbs)
	Without stand	14.6 kg (32.1 lbs)	20.0 kg (44.0 lbs)
Current Value / Power consumption		1.2 A / 120 W	1.4 A / 140 W

MODELS		60LA7400 (60LA7400-UA)
Dimensions (W x H x D)	With stand	1,352 x 848 x 316 (mm)
		53.2 x 33.3 x 12.4 (inch)
	Without stand	1,352 x 794 x 59.9 (mm)
		53.2 x 31.2 x 2.3 (inch)
Weight	With stand	27.6 kg (60.8 lbs)
	Without stand	24.8 kg (54.6 lbs)
Current Value / Power consumption		1.8 A / 180 W

## HDMI (DTV) supported mode

Resolution	Horizontal Frequency (kHz)	Vertical Frequency (Hz)
720X480	31.469 31.50	59.94 60.00
1280X720	44.96 45.00	59.94 60.00
1920X1080	33.72 33.75 26.97 27.000 33.716 33.75 67.43 67.500	59.94 60.00 23.97 24.000 29.976 30.00 59.94 60

## Component supported mode

Resolution	Horizontal Frequency (kHz)	Vertical Frequency (Hz)
720x480i	15.73 15.73	59.94 60.00
720x480p	31.47 31.50	59.94 60
1280x720p	44.96 45.00	59.94 60.00
1920x1080i	33.72 33.75	59.94 60.00
1920x1080p	26.97 27.00 33.71 33.75 67.432 67.500	23.976 24.00 29.97 30.00 59.94 60.00

## Component port connecting information

Component ports on the TV	Y	PB	PR
---------------------------	---	----	----

Video output ports on DVD player	Y	PB	PR
	Y	B-Y	R-Y
	Y	Cb	Cr
	Y	Pb	Pr

## HDMI (PC) supported mode

Resolution	Horizontal Frequency (kHz)	Vertical Frequency (Hz)
640 x 480	31.469	59.94
800 x 600	37.879	60.31
1024 x 768	48.363	60.00
1152 x 864	54.348	60.053
1360 x 768	47.712	60.015
1280 x 1024	63.981	60.020
1920 x 1080	67.5	60.00

## Wireless LAN module (WN8122E1) specification

Standard	IEEE802.11a/b/g/n
Frequency Range	2400 to 2483.5 MHz 5150 to 5250 MHz 5725 to 5850 MHz
Output Power (Max.)	802.11a: 16.5 dBm 802.11b: 16 dBm 802.11g: 15.5 dBm 802.11n - 2.4GHz: 15.5 dBm 802.11n - 5GHz: 16.5 dBm

- Because band channel used by the country could be different, the user can not change or adjust the operating frequency and this product is set for the regional frequency table.
- Contains FCC ID: BEJWN8122E1  
Contains IC: 2703H-WN8122E1

## Bluetooth module (BM-LDS401) specification

Standard	Bluetooth Version 3.0
Frequency Range	2400 ~ 2483.5 MHz
Output Power (Max.)	10 dBm or lower

- Contains FCC ID: BEJLDS401  
Contains IC: 2703H-LDS401

### 3D supported mode (For 3D TV)

- Video, which is input as below media contents is switched into the 3D screen automatically.

3D supported mode automatically				
Input	Signal	Horizontal Frequency (kHz)	Vertical Frequency (Hz)	Playable 3D video format
HDMI	1080p	54.00	24	F/P, L/A
		67.50	30	
		27.00	24	
		33.75	30	
		67.50	60	
	1080i	67.50	60	F/P, F/A
		33.75		S/S, T&B, S/S Full
	720p	90.00		F/P, L/A
		45.00		S/S, T&B, S/S Full
	480p	63.00		F/P, L/A
		31.50		T/B, S/S, S/S Full
	USB	1080p	33.75	30
DLNA				
<b>Playable 3D video format</b>				
DTV	Dual Stream			

S/S : Side by Side , T/B : Top & Bottom, F/P : Frame Packing, F/A : Field Alternative  
 L/A : Line Alternative, S/S Full :Side by Side Full, C/B : Checker Board  
 R/I : Row Interleaving, C/I: Column Interleaving, F/S : Single Frame Sequential

3D supported mode manually		
Input	Signal	Playable 3D video format
TV	-	2D to 3D, S/S, T&B
ATV(CVBS)	-	
Component	-	
HDMI-PC	1080p	2D to 3D, S/S, T&B, C/B, R/I, C/I (60Hz : F/S)
	Others	2D to 3D, S/S, T&B
HDMI-DTV	Interlace	2D to 3D, S/S, T&B
	Progressive	2D to 3D, S/S, T&B, C/B, R/I, C/I (60Hz : F/S)
USB / DLNA (Movie)	704 x 480p (Over)	2D to 3D, S/S, T&B, C/B, R/I, C/I (60Hz : F/S)
	704 x 480i (Over)	2D to 3D, S/S, T&B
	704 x 480 (Under)	2D to 3D
USB / DLNA (Photo)	320 x 240 (Over)	2D to 3D, S/S, T&B
	320 x 240 (Under)	2D to 3D
Miracast™ / WiDi	1024 x 768p	2D to 3D, S/S, T&B
	1280 x 720p	
	1920 x 1080p	
	Others	2D to 3D

## EXTERNAL CONTROL DEVICE SETUP

To obtain the external control device setup information, please visit '[www.lg.com](http://www.lg.com)'.



# MAINTENANCE

## Cleaning Your TV

Clean your TV regularly to keep it at peak performance and to extend the product lifespan.



### CAUTION

- Before Cleaning, turn the power off and disconnect the power cord and all other cables.
- When the TV is left unattended or unused for a long time, disconnect the power cord from the wall outlet to prevent possible damage from lightning or power surges.

### Screen, frame, cabinet and stand

To remove dust or light dirt, wipe the surface with a dry, clean, and soft cloth.

To remove major dirt, wipe the surface with a soft cloth dampened in clean water or a diluted mild detergent. Then wipe immediately with a dry cloth.



### CAUTION

- Do not push, rub, or hit the surface with your fingernail or a sharp object, as this may result in scratches on the screen and image distortions.
- Do not use any chemicals, such as waxes, benzene, alcohol, thinners, insecticides, air fresheners, lubricants, as these may damage the screen's finish and cause discoloration.
- Do not spray liquid onto the surface. If water enters the TV, it may result in fire, electric shock, or malfunction.

### Power cord

Remove the accumulated dust or dirt on the power cord regularly.

ENGLISH

# TROUBLESHOOTING

Problem	Solution
Cannot control the TV with the remote control.	<ul style="list-style-type: none"> <li>• Check the remote control sensor on the product and try again.</li> <li>• Check if there is any obstacle between the product and the remote control.</li> <li>• Check if the batteries are still working and properly installed (⊕ to ⊕, ⊖ to ⊖).</li> </ul>
No image display and no sound is produced.	<ul style="list-style-type: none"> <li>• Check if the product is turned on.</li> <li>• Check if the power cord is connected to a wall outlet.</li> <li>• Check if there is a problem in the wall outlet by connecting other products.</li> </ul>
The TV turns off suddenly.	<ul style="list-style-type: none"> <li>• Check the power control settings. The power supply may be interrupted.</li> <li>• Check if the Auto sleep feature is activated in the Time settings.</li> <li>• If there is no signal while the TV is on, the TV will turn off automatically after 15 minutes of inactivity.</li> </ul>



# CHILD SAFETY:

It Makes A Difference How and Where  
You Use Your Flat Panel Display

**Congratulations on your purchase! As you enjoy your new product, please keep these safety tips in mind:**



## THE ISSUE

- The home theater entertainment experience is a growing trend and larger flat panel displays are popular purchases. However, flat panel displays are not always supported on the proper stands or installed according to the manufacturer's recommendations.
- Flat panel displays that are inappropriately situated on dressers, bookcases, shelves, desks, speakers, chests or carts may fall over and cause injury.

## THIS MANUFACTURER CARES!

- The consumer electronics industry is committed to making home entertainment enjoyable and safe.

## TUNE INTO SAFETY

- One size does NOT fit all. Follow the manufacturer's recommendations for the safe installation and use of your flat panel display.
- Carefully read and understand all enclosed instructions for proper use of this product.
- Don't allow children to climb on or play with furniture and television sets.
- Don't allow place flat panel displays on furniture that can easily be used as steps, such as a chest of drawers.
- Remember that children can become excited while watching a program, especially on a "larger than life" flat panel display. Care should be taken to place or install the display where it cannot be pushed, pulled over, or knocked down.
- Care should be taken to route all cords and cables connected to the flat panel display so that they cannot be pulled or grabbed by curious children.

## WALL MOUNTING: IF YOU DECIDE TO WALL MOUNT YOUR FLAT PANEL DISPLAY, ALWAYS:

- Use a mount that has been recommended by the display manufacturer and/or listed by an independent laboratory (such as UL, CSA, ETL).
- Follow all instructions supplied by the display and wall mount manufacturers.
- If you have any doubts about your ability to safely install your flat panel display, contact your retailer about professional installation.
- Make sure that the wall where you are mounting the display is appropriate. Some wall mounts are not designed to be mounted to walls with steel studs or old cinder block construction. If you are unsure, contact a professional installer.
- A minimum of two people are required for installation. Flat panel displays can be heavy





### LG Customer Information Center

For inquiries or comments, visit [www.lg.com](http://www.lg.com) or call;

**1-800-243-0000** USA, Consumer User

**1-888-865-3026** USA, Commercial User

**1-888-542-2623** CANADA

Register your product Online!

[www.lg.com](http://www.lg.com)

The model and serial number of the TV is located on the back and one side of the TV. Record it below should you ever need service.

MODEL \_\_\_\_\_

SERIAL \_\_\_\_\_



This product qualifies for ENERGY STAR in the "factory default (Home Use)" setting.

Changing the factory default settings or enabling other features may increase power consumption that could exceed the limits necessary to qualify for ENERGY STAR.



OWNER'S MANUAL

# EXTERNAL CONTROL DEVICE SETUP

Please read this manual carefully before operating the set and retain it for future reference.

# KEY CODES

- This feature is not available for all models.

Code (Hexa)	Function	Note	Code (Hexa)	Function	Note
00	CH +, PR +	R/C Button	45	Q.Menu	R/C Button
01	CH -, PR -	R/C Button	4C	List, - (ATSC Only)	R/C Button
02	Volume +	R/C Button	53	List	R/C Button
03	Volume -	R/C Button	5B	Exit	R/C Button
06	> (Arrow Key / Right Key)	R/C Button	61	Blue	R/C Button
07	< (Arrow Key / Left Key)	R/C Button	63	Yellow	R/C Button
08	Power	R/C Button	71	Green	R/C Button
09	Mute	R/C Button	72	Red	R/C Button
0B	Input	R/C Button	79	Ratio / Aspect Ratio	R/C Button
0E	SLEEP	R/C Button	91	AD (Audio Description)	R/C Button
0F	TV, TV/RAD	R/C Button	7A	User Guide	R/C Button
10 - 19	Number Key 0 - 9	R/C Button	7C	Smart / Home	R/C Button
1A	Q.View / Flashback	R/C Button	7E	SIMPLINK	R/C Button
1E	FAV (Favorite Channel)	R/C Button	8E	▶▶ (Forward)	R/C Button
20	Text (Teletext)	R/C Button	8F	◀◀ (Rewind)	R/C Button
21	T. Opt (Teletext Option)	R/C Button	AA	Info	R/C Button
28	Return (BACK)	R/C Button	AB	Program Guide	R/C Button
30	AV (Audio / Video) Mode	R/C Button	B0	▶ (Play)	R/C Button
39	Caption/Subtitle	R/C Button	B1	■ (Stop / Live TV)	R/C Button
40	∧ (Arrow Key / Cursor Up)	R/C Button	BA	(Freeze / Slow Play / Pause)	R/C Button
41	∨ (Arrow Key / Cursor Down)	R/C Button	BD	● (REC)	R/C Button
42	My Apps	R/C Button	DC	3D	R/C Button
43	Menu / Settings	R/C Button	9F	App / *	R/C Button
44	OK / Enter	R/C Button			

- \* Key code 4C (0x4C) is available on ATSC/ISDB models which use major/minor channel. (For South Korea, Japan, North America, Latin America except Colombia models)

# EXTERNAL CONTROL DEVICE SETUP

- Image shown may differ from your TV.

Connect the USB to Serial converter/RS-232C input jack to an external control device (such as a computer or an A/V control system) to control the product's functions externally.

Note: The type of control port on the TV can be different between model series.

- \* Please be advised that not all models support this type of connectivity.
- \* Cable is not provided.

## USB to Serial converter with USB Cable

USB Type

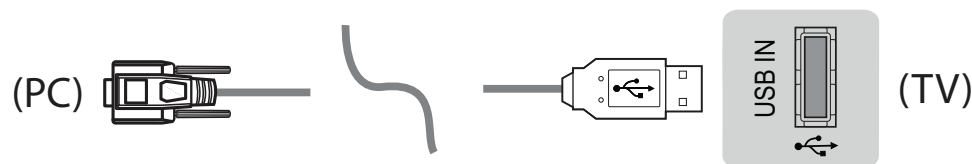

- LGTV supports PL2303 chip-based (Vendor ID : 0x0557, Product ID : 0x2008) USB to serial converter which is not made nor provided by LG.
- It can be purchased from computer stores that carry accessories for IT support professionals.

### RS-232C with RS-232C Cable (Legacy)

Phone jack Type

- You need to purchase the phone-jack to RS-232 cable required for the connection between the PC and the TV, which is specified in the manual.
- \* For other models, connect to the USB port.

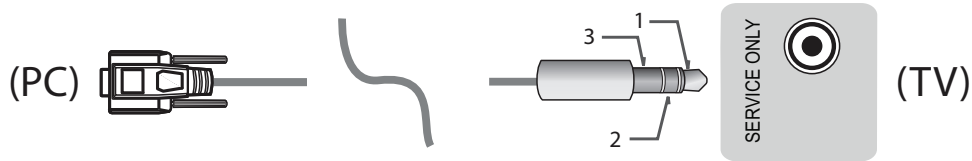

- This connection can only be used for the following models: 55/47/39LN5450-UA, 55/50/47/42LN5400-UA, 42/39/32LN5300-UA, and 37/32LN530B-UA.

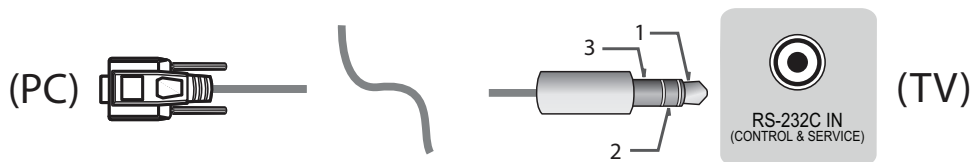

- This connection can only be used for the following models: 42/50PN4500-UA, 50/60PN5300-UF, 50/60PN6500-UA, and 60PN6550-UA.

### Customer Computer

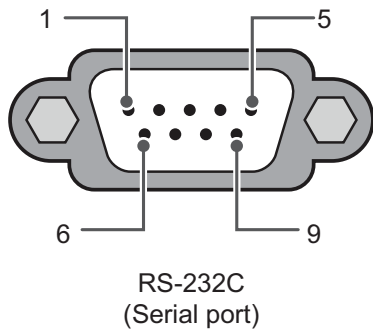

### RS-232C configurations

3-Wire Configurations(Not standard)

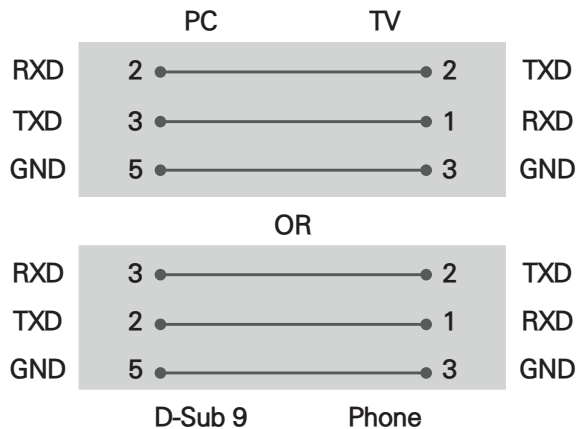

### Set ID

For Set ID number, see "Real Data Mapping" on p.6

- Press **SETTINGS** to access the main menus.
- Press the Navigation buttons to scroll to **OPTION** and press **OK**.
- Press the Navigation buttons to scroll to **SET ID** and press **OK**.
- Scroll left or right to select a set ID number and select **CLOSE**. The adjustment range is 1-99.
- When you are finished, press **EXIT**.



## Communication Parameters

- Baud rate : 9600 bps (UART)
- Data length : 8 bits
- Parity : None
- Stop bit : 1 bit
- Communication code : ASCII code
- Use a crossed (reverse) cable.

## Command reference list

(Depending on model)

	COMMAND1	COMMAND2	DATA (Hexadecimal)		COMMAND1	COMMAND2	DATA (Hexadecimal)
01. Power off	k	a	00	13. Balance	k	t	00 to 64
02. Aspect Ratio	k	c	(p.7)	14. Color (Colour) Temperature	x	u	00 to 64
03. Screen Mute	k	d	(p.7)	15. ISM Method (Only Plasma TV)	j	p	(p.8)
04. Volume Mute	k	e	00 to 01	16. Energy Saving	j	q	00 to 05
05. Volume Control	k	f	00 to 64	17. Tune Command	m	a	(p.8)
06. Contrast	k	g	00 to 64	18. Channel (Programme) Add/Del(Skip)	m	b	00 to 01
07. Brightness	k	h	00 to 64	19. Key	m	c	Key Codes
08. Color/ Colour	k	i	00 to 64	20. Control Back Light, Control Panel Light	m	g	00 to 64
09. Tint	k	j	00 to 64	21. Input select (Main)	x	b	(p.10)
10. Sharpness	k	k	00 to 32	22. 3D (Only 3D models)	x	t	(p.11)
11. OSD Select	k	l	00 to 01	23. Extended 3D (Only 3D models)	x	v	(p.11)
12. Remote Control Lock Mode	k	m	00 to 01				

\* Note: During USB operations such as DivX or EMF, all commands except Power(ka) and Key(mc) are not executed and treated as NG.

## Transmission / Receiving Protocol

### Transmission

[Command1][Command2][ ][Set ID][ ][Data][Cr]

[Command 1] : First command to control the TV. (j, k, m or x)

[Command 2] : Second command to control the TV.

[Set ID] : You can adjust the [Set ID] to choose desired monitor ID number in option menu.

Adjustment range in TV is 1 to 99. If [Set ID] value is selected to '0', every connected set can be controlled.

\* [Set ID] is indicated as decimal (1 to 99) on menu and as Hexadecimal (0x00 to 0x63) on transmission/receiving protocol.

[DATA] : To transmit command data (hexadecimal). Transmit 'FF' data to read status of command.

[Cr] : Carriage Return - ASCII code '0x0D'

[ ] : Space - ASCII code '0x20'

### OK Acknowledgement

[Command2][ ][Set ID][ ][OK][Data][x]

\* The set transmits ACK (acknowledgement) based on this format when receiving normal data. At this time, if the data is data read mode, it indicates present status data. If the data is data write mode, it returns the data of the PC computer.

### Error Acknowledgement

[Command2][ ][Set ID][ ][NG][Data][x]

\* The set transmits ACK (acknowledgement) based on this format when receiving abnormal data from non-viable functions or communication errors.

Data 00: Illegal Code

### Real data mapping (Hexadecimal → Decimal)

\* When you enter the [data] in hexadecimal, refer to following conversion table.

\* Channel Tune (ma) Command uses two-byte hexadecimal value([data]) to select channel number.

00 : Step 0	32 : Step 50 (Set ID 50)	FE : Step 254
01 : Step 1 (Set ID 1)	33 : Step 51 (Set ID 51)	FF : Step 255
...	...	...
0A : Step 10 (Set ID 10)	63 : Step 99 (Set ID 99)	01 00 : Step 256
...	...	...
0F : Step 15 (Set ID 15)	C7 : Step 199	27 0E : Step 9998
10 : Step 16 (Set ID 16)	C8 : Step 200	27 0F : Step 9999
...	...	...

\* Commands may work differently depending on model and signal.

### 01. Power (Command: k a)

- ▶ To control Power Off of the set.

Transmission [k][a][ ][Set ID][ ][Data][Cr]

Data 00 : Power Off

Ack [a][ ][Set ID][ ][OK/NG][Data][x]

- ▶ To Show Power On. (Works TV is On Only)

Transmission [k][a][ ][Set ID][ ][FF][Cr]

Ack [a][ ][Set ID][ ][OK][01][x]

\* Similarly, if other functions transmit 'FF' data based on this format, Acknowledgement feedback presents status about each function.

### 02. Aspect Ratio (Command: k c) (Main Picture Size)

- ▶ To adjust the screen format. (Main picture format)  
You can also adjust the screen format using the Aspect Ratio in the Q.MENU. or PICTURE menu.

Transmission [k][c][ ][Set ID][ ][Data][Cr]

Data 01 : Normal screen (4:3)	07 : 14:9 (Europe, Colombia, Mid-East,
02 : Wide screen (16:9)	Asia except South Korea and Japan)
04 : Zoom	09 : * Just Scan
05 : Zoom 2 (Latin America except Colombia Only)	0B : Full Wide (Europe, Colombia, Mid- East, Asia except South Korea and Japan)
06 : Set by Program/ Original	10 to 1F : Cinema Zoom 1 to 16

Ack [c][ ][Set ID][ ][OK/NG][Data][x]

- \* Using the PC input, you select either 16:9 or 4:3 screen aspect ratio.
- \* In DTV/HDMI/Component mode (high-definition), Just Scan is available.
- \* Full wide mode may work differently based on model and is supported for DTV fully, and ATV, AV partially.

### 03. Screen Mute (Command: k d)

- ▶ To select screen mute on/off.

Transmission [k][d][ ][Set ID][ ][Data][Cr]

Data 00 : Screen mute off (Picture on)  
Video mute off  
01 : Screen mute on (Picture off)  
10 : Video mute on

Ack [d][ ][Set ID][ ][OK/NG][Data][x]

\* In case of video mute on only, TV will display On Screen Display(OSD). But, in case of Screen mute on, TV will not display OSD.

### 04. Volume Mute (Command: k e)

- ▶ To control volume mute on/off.  
You can also adjust mute using the MUTE button on remote control.

Transmission [k][e][ ][Set ID][ ][Data][Cr]

Data 00 : Volume mute on (Volume off)  
01 : Volume mute off (Volume on)

Ack [e][ ][Set ID][ ][OK/NG][Data][x]

### 05. Volume Control (Command: k f)

- ▶ To adjust volume.  
You can also adjust volume with the volume buttons on remote control.

Transmission [k][f][ ][Set ID][ ][Data][Cr]

Data Min : 00 to Max : 64

Ack [f][ ][Set ID][ ][OK/NG][Data][x]

### 06. Contrast (Command: k g)

- ▶ To adjust screen contrast.  
You can also adjust contrast in the PICTURE menu.

Transmission [k][g][ ][Set ID][ ][Data][Cr]

Data Min : 00 to Max : 64

Ack [g][ ][Set ID][ ][OK/NG][Data][x]

### 07. Brightness (Command: k h)

- ▶ To adjust screen brightness.  
You can also adjust brightness in the PICTURE menu.

Transmission [k][h][ ][Set ID][ ][Data][Cr]

Data Min : 00 to Max : 64

Ack [h][ ][Set ID][ ][OK/NG][Data][x]

### 08. Color/Colour (Command: k i)

- ▶ To adjust the screen Color(Colour).  
You can also adjust colour in the PICTURE menu.

Transmission [k][i][ ][Set ID][ ][Data][Cr]

Data Min : 00 to Max : 64

Ack [i][ ][Set ID][ ][OK/NG][Data][x]

## 09. Tint (Command: k j)

- ▶ To adjust the screen tint.  
You can also adjust tint in the PICTURE menu.

Transmission [k][j][ ][Set ID][ ][Data][Cr]

Data Red : 00 to Green : 64

Ack [j][ ][Set ID][ ][OK/NG][Data][x]

## 10. Sharpness (Command: k k)

- ▶ To adjust the screen sharpness.  
You can also adjust sharpness in the PICTURE menu.

Transmission [k][k][ ][Set ID][ ][Data][Cr]

Data Min : 00 to Max : 32

Ack [k][ ][Set ID][ ][OK/NG][Data][x]

## 11. OSD Select (Command: k l)

- ▶ To select OSD (On Screen Display) on/off when controlling remotely.

Transmission [k][l][ ][Set ID][ ][Data][Cr]

Data 01 : OSD off          01 : OSD on

Ack [l][ ][Set ID][ ][OK/NG][Data][x]

## 12. Remote control lock mode (Command: k m)

- ▶ To lock the front panel controls on the monitor and remote control.

Transmission [k][m][ ][Set ID][ ][Data][Cr]

Data 01 : Lock off          01 : Lock on

Ack [m][ ][Set ID][ ][OK/NG][Data][x]

- \* If you are not using the remote control, use this mode.  
When main power is off & on (plug-off and plug-in, after 20 - 30 seconds), external control lock is released.
- \* In the standby mode (DC off by off timer or 'ka', 'mc' command), and if key lock is on, TV will not turn on by power on key of IR & Local Key.

## 13. Balance (Command: k t)

- ▶ To adjust balance.  
You can also adjust balance in the AUDIO menu.

Transmission [k][t][ ][Set ID][ ][Data][Cr]

Data Min : 00 to Max : 64

Ack [t][ ][Set ID][ ][OK/NG][Data][x]

## 14. Color(Colour) Temperature (Command: x u)

- ▶ To adjust colour temperature. You can also adjust Color(Colour) Temperature in the PICTURE menu.

Transmission [x][u][ ][Set ID][ ][Data][Cr]

Data Min : 00 to Max : 64

Ack [u][ ][Set ID][ ][OK/NG][Data][x]

## 15. ISM Method (Command: j p) (Only Plasma TV)

- ▶ To control the ISM method. You can also adjust ISM Method in OPTION menu.

Transmission [j][p][ ][Set ID][ ][Data][Cr]

Data Min : 02: Orbiter

08: Normal

20: Color(Colour) Wash

Ack [p][ ][Set ID][ ][OK/NG][Data][x]

## 16. Energy Saving (Command: j q)

- ▶ To reduce the power consumption of the TV. You can also adjust Energy Saving in PICTURE menu.

Transmission [j][q][ ][Set ID][ ][Data][Cr]

Data

00 : Off

01 : Minimum

02 : Medium

03 : Maximum

04 : Auto

05 : Screen off

\* (Depending on model)

Ack [q][ ][Set ID][ ][OK/NG][Data][x]

## 17. Tune Command (Command: m a)

- \* This command may work differently depending on model and signal.
- For Europe, Mid-East, Colombia, Asia except South Korea and Japan, Model
  - ▶ Select channel to following physical number.

Transmission [m][a][ ][Set ID][ ][Data 00][ ][Data 01][ ][Data 02][Cr]

\* Analogue Terrestrial/Cable

[Data 00][Data 01] Channel Data

Data 00 : High byte channel data

Data 01 : Low byte channel data

- 00 00 ~ 00 C7 (Decimal : 0 ~ 199)

Data 02 : Input Source (Analogue)

- 00 : Terrestrial TV (ATV)

- 80 : Cable TV (CATV)

## \* Digital Terrestrial/Cable/Satellite

[Data 00][Data 01]: Channel Data

Data 00 : High Channel data

Data 01 : Low Channel data

- 00 00 ~ 27 0F (Decimal: 0 ~ 9999)

Data 02 : Input Source (Digital)

- 10 : Terrestrial TV (DTV)

- 20 : Terrestrial Radio (Radio)

- 40 : Satellite TV (SDTV)

- 50 : Satellite Radio (S-Radio)

- 90 : Cable TV (CADTV)

- a0 : Cable Radio (CA-Radio)

## \* Tune Command Examples:

## 1. Tune to the analogue terrestrial (PAL) Channel 10.

Set ID = All = 00

Data 00 &amp; 01 = Channel Data is 10 = 00 0a

Data 02 = Analogue Terrestrial TV = 00

Result = **ma 00 00 0a 00**

## 2. Tune to the digital terrestrial (DVB-T) Channel 01.

Set ID = All = 00

Data 00 &amp; 01 = Channel Data is 1 = 00 01

Data 02 = Digital Terrestrial TV = 10

Result = **ma 00 00 01 10**

## 3. Tune to the satellite (DVB-S) Channel 1000.

Set ID = All = 00

Data 00 &amp; 01 = Channel Data is 1000 = 03 E8

Data 02 = Digital Satellite TV = 40

Result = **ma 00 03 E8 40**

Ack [a][ ][Set ID][ ][OK][Data 00][Data 01]

[Data 02][x][a][ ][Set ID][ ][NG][Data 00][x]

- For South Korea, North/Latin America except Colombia Model

- ▶ To tune channel to following physical/major/minor number.

Transmission [m][a][ ][0][ ][Data00][ ][Data01]

[ ][Data02][ ][Data03][ ][Data04][ ][Data05][Cr]

Digital channels have a Physical, Major, and Minor channel number. The Physical number is the actual digital channel number, the Major is the number that the channel should be mapped to, and the Minor is the sub-channel. Since the ATSC tuner automatically maps the channel from the Major / Minor number, the Physical number is not required when sending a command in Digital.

## \* Analogue Terrestrial/Cable

Data 00 : Physical Channel Number

- Terrestrial (ATV) : 02~45 (Decimal: 2 ~ 69)

- Cable (CATV) : 01, 0E~7D (Decimal : 1, 14~125)

[Data 01 ~ 04]: Major/Minor Channel Number

Data 01 &amp; 02: xx (Don't care)

Data 03 &amp; 04: xx (Don't care)

Data 05: Input Source (Analogue)

- 00 : Terrestrial TV (ATV)

- 01 : Cable TV (CATV)

## \* Digital Terrestrial/Cable

Data 00 : xx (Don't care)

[Data 01][Data 02]: Major Channel Number

Data 01 : High byte Channel Data

Data 02 : Low byte Channel Data

- 00 01 ~ 27 0F (Decimal: 1 ~ 9999)

[Data 03][Data 04]: Minor Channel Number

Data 03 : High byte Channel Data

Data 04 : Low byte Channel Data

Data 05 : Input Source (Digital)

- 02 : Terrestrial TV (DTV) – Use Physical Channel Number

- 06 : Cable TV (CADTV) – Use Physical Channel Number

- 22 : Terrestrial TV (DTV) – Don't Use Physical Channel Number

- 26 : Cable TV (CADTV) - Don't Use Physical Channel Number

- 46 : Cable TV (CADTV) – Use Major Channel Number Only (One Part Channel)

Two bytes are available for each major and minor channel data, but usually the low byte is used alone (high byte is 0).

## \* Tune Command Examples:

## 1. Tune to the analogue cable (NTSC) channel 35.

Set ID = All = 00

Data 00 = Channel Data is 35 = 23

Data 01 &amp; 02 = No Major = 00 00

Data 03 &amp; 04 = No Minor = 00 00

Data 05 = Analogue Cable TV = 01

Total = **ma 00 23 00 00 00 01**

## 2. Tune to the digital terrestrial (ATSC) channel 30-3.

Set ID = All = 00

Data 00 = Don't know Physical = 00

Data 01 &amp; 02 = Major is 30 = 00 1E

Data 03 &amp; 04 = Minor is 3 = 00 03

Data 05 = Digital Terrestrial TV = 22

Total = **ma 00 00 00 1E 00 03 22**

Ack [a][ ][Set ID][ ][OK][Data 00][Data 01]

[Data 02][Data 03][Data 04][Data 05]

[x][a][ ][Set ID][ ][NG][Data 00][x]

- For Japan Model

- ▶ To tune channel to following physical/major/minor number.

Transmission [m][a][ ][0][ ][Data00][ ][Data01]

[ ][Data02][ ][Data03][ ][Data04][ ][Data05][Cr]

## \* Digital Terrestrial/Satellite

Data 00: xx (Don't care)

[Data 01][Data 02]: Major Channel Number  
 Data 01: High byte Channel Data  
 Data 02: Low byte Channel Data  
 - 00 01 ~ 27 0F (Decimal: 1 ~ 9999)

[Data 03][Data 04]: Minor/Branch Channel Number  
 (Don't care in Satellite)  
 Data 03: High byte Channel Data  
 Data 04: Low byte Channel Data

Data 05 : Input Source (Digital/Satellite for Japan)  
 - 02 : Terrestrial TV (DTV)  
 - 07 : BS (Broadcasting Satellite)  
 - 08 : CS1 (Communication Satellite 1)  
 - 09 : CS2 (Communication Satellite 2)

\* Tune Command Examples:

1 Tune to the digital terrestrial (ISDB-T) channel 17-1.  
 Set ID = All = 00  
 Data 00 = Don't know Physical = 00  
 Data 01 & 02 = Major is 17 = 00 11  
 Data 03 & 04 = Minor/Branch is 1 = 00 01  
 Data 05 = Digital Terrestrial TV = 02  
 Total = **ma 00 00 00 11 00 01 02**

2. Tune to the BS (ISDB-BS) channel 30.  
 Set ID = All = 00  
 Data 00 = Don't know Physical = 00  
 Data 01 & 02 = Major is 30 = 00 1E  
 Data 03 & 04 = Don't Care = 00 00  
 Data 05 = Digital BS TV = 07  
 Total = **ma 00 00 00 1E 00 00 07**

\* This feature is varied based on the model.

```
Ack [a][ ][Set ID][ ][OK][Data 00][Data 01]
[Data 02][Data 03][Data 04][Data 05]
[x][a][ ][Set ID][ ][NG][Data 00][x]
```

18. Channel(Programme) Add/Del(Skip)  
 (Command: m b)

► To skip current channel(programme) for next time.

```
Transmission [m][b][ ][Set ID][ ][Data][Cr]
```

Data 00 : Del(ATSC,ISDB)/Skip(DVB) 01 : Add

```
Ack [b][ ][Set ID][ ][OK/NG][Data][x]
```

\* Set the saved channel status to del(ATSC, ISDB)/skip(DVB) or add.

19. Key (Command: m c)

► To send IR remote key code.

```
Transmission [m][c][ ][Set ID][ ][Data][Cr]
```

Data Key code - p.2.

```
Ack [c][ ][Set ID][ ][OK/NG][Data][x]
```

20. Control Back Light (Command: m g)

• For LCD TV / LED TV  
 ► To control the back light.

```
Transmission [m][g][ ][Set ID][ ][Data][Cr]
```

Data Min : 00 to Max : 64

```
Ack [g][ ][Set ID][ ][OK/NG][Data][x]
```

Control Panel Light (Command: m g)

• For Plasma TV  
 ► To control the panel light.

```
Transmission [m][g][ ][Set ID][ ][Data][Cr]
```

Data Min : 00 to Max : 64

```
Ack [g][ ][Set ID][ ][OK/NG][Data][x]
```

21. Input select (Command: x b)  
 (Main Picture Input)

► To select input source for main picture.

```
Transmission [x][b][ ][Set ID][ ][Data][Cr]
```

Data

00 : DTV	01 : CADTV
02 : Satellite DTV	10 : ATV
	ISDB-BS (Japan)
03 : ISDB-CS1 (Japan)	
04 : ISDB-CS2 (Japan)	
11 : CATV	

20 : AV or AV1	21 : AV2
----------------	----------

40 : Component1	41 : Component2
-----------------	-----------------

90 : HDMI1	91 : HDMI2
92 : HDMI3	93 : HDMI4

```
Ack [b][ ][Set ID][ ][OK/NG][Data][x]
```

\* This function depends on model and signal.

## 22. 3D(Command: x t) (only 3D models)

(Depending on model)

- ▶ To change 3D mode for TV.

```
Transmission [x][t][ ][Set ID][ ][Data 00][ ][Data 01]
[ ][Data 02][ ][Data 03][Cr]
```

## Data Structure

[Data 00] 00 : 3D On

01 : 3D Off

02 : 3D to 2D

03 : 2D to 3D

[Data 01] 00 : Top and Bottom

01 : Side by Side

02 : Check Board

03 : Frame Sequential

04 : Column interleaving

05 : Row interleaving

[Data 02] 00 : Right to Left

01 : Left to Right

[Data 03] 3D Effect(3D Depth): Min : 00 - Max : 14  
(\*transmit by Hexadecimal code)

- \* If [Data 00] is 00 (3D On), [Data 03] has no meaning.
- \* If [Data 00] is 01 (3D off) or 02 (3D to 2D), [Data 01], [Data 02] and [Data 03] have no meaning.
- \* If [Data 00] is 03(2D to 3D), [Data 01] and [Data 02] have no meaning.
- \* All 3D pattern options ([Data 01]) may not be available according to broadcasting/video signal.

[Data 00]	[Data 01]	[Data 02]	[Data 03]
00	O	O	X
01	X	X	X
02	X	X	X
03	X	X	O

X : don't care

```
Ack [t][ ][Set ID][ ][OK][Data00][Data01][Data02]
[Data03][x]
[t][ ][Set ID][ ][NG][Data00][x]
```

23. Extended 3D(Command: x v) (only 3D models)  
(Depending on model)

- ▶ To change 3D option for TV.

```
Transmission [x][v][ ][Set ID][ ][Data 00][ ]
[Data 01][Cr]
```

[Data 00] 3D option

00 : 3D Picture Correction

01 : 3D Depth (3D Mode is Manual Only)

02 : 3D Viewpoint

06 : 3D Color Correction

07 : 3D Sound Zooming

08 : Normal Image View

09 : 3D Mode (Genre)

[Data 01] It has own range for each 3D option  
determined by [Data 00].

1) When [Data 00] is 00

00 : Right to Left

01 : Left to Right

2) When [Data 00] is 01, 02

Data Min: 0 - Max: 14 (\*transmit by Hexadecimal  
code)Data value range(0 - 20) converts Viewpoint range  
(-10 - +10) automatically (Depending on model)

3) When [Data 00] is 06, 07, 08

00 : Off

01 : On

4) When [Data 00] is 09

00 : Standard

01 : Sport

02 : Cinema

03 : Extreme

04 : Manual

```
Ack [v][ ][Set ID][ ][OK][Data00][Data01][x]
[v][ ][Set ID][ ][NG][Data00][x]
```





- \* Image shown may differ from your TV.
- \* Image shown on a PC or mobile phone may vary depending on the Operating System (OS).

## Wireless Network Connection



or



## Wired Network Connection

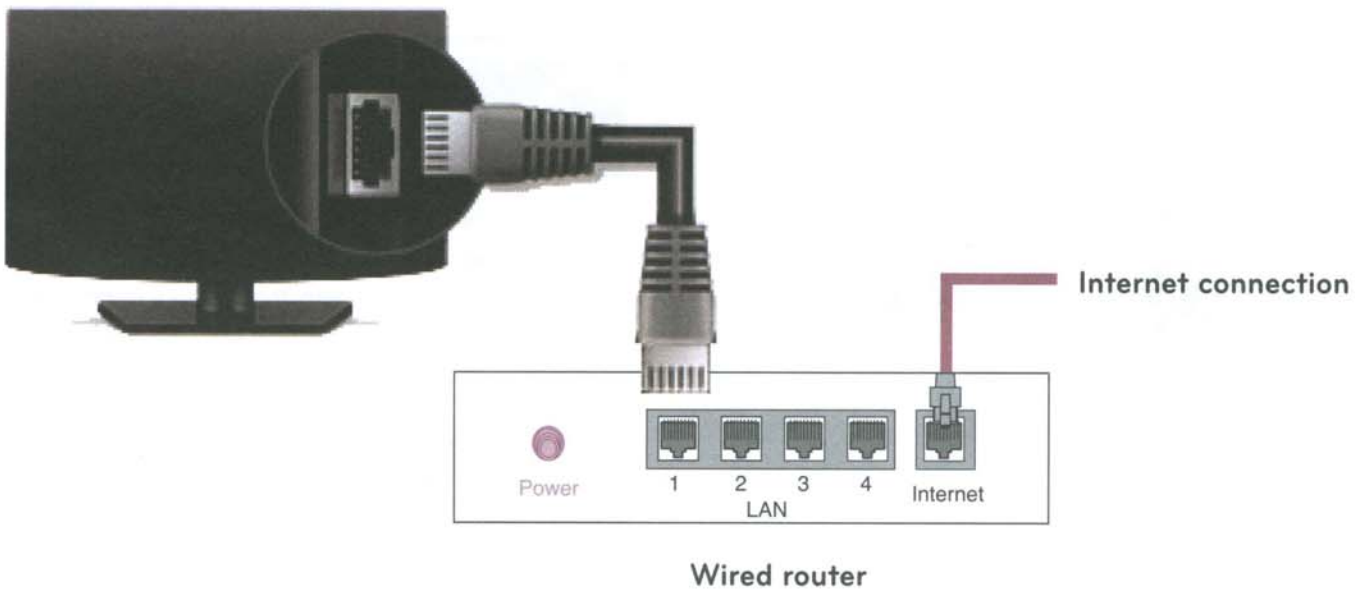

# NETWORK SETTING

ENGLISH

Premium Apps are pre-installed on the TV. These may vary by country.

- 1 Press the **SMART**  button to access the Home menu. Select **Settings** and press **Wheel(OK)**.



- 2 Select the **NETWORK**  **Network Connection** menu.



- 3 Select the **Start Connection**.

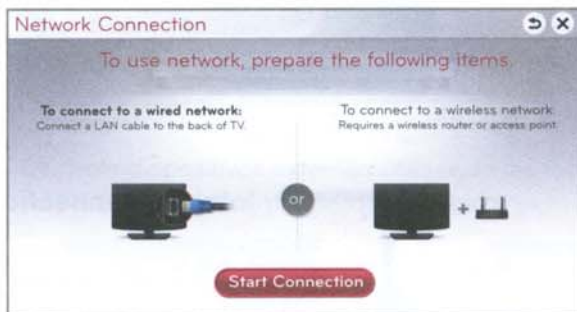

- 4 The device automatically tries to connect to the network available (wired network first).

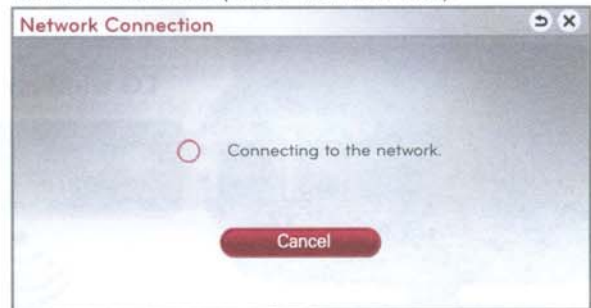

If you select **Cancel** or it fails to connect to the network, the network list available is displayed. Choose the network you wish to use.

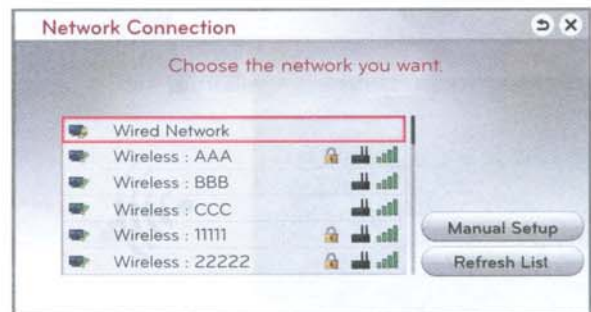

For wireless AP(Router) that have the  symbol, you need to enter the security key.

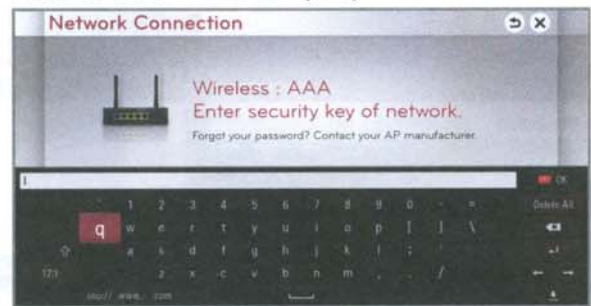

- 5 The connected network is displayed. Select **Complete** to confirm the network connection. If you select the **Other Network List**, the available network list is displayed again.

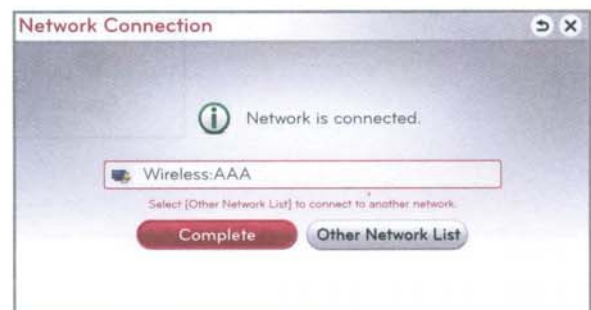

# Troubleshooting Network Problems

- 1 Press the **SMART**  button to access the Smart Home menu. Select **Settings** and press **Wheel(OK)**.



**Check the AP(Router) or consult your Internet service provider.**



**When an ✓ appears on TV and Gateway, but an X on DNS.**

- 1 Unplug the power cord of the AP(Router), cable modem and try to connect after 5 seconds.
- 2 Initialize(Reset) the AP(Router) or cable modem.
- 3 Contact internet companies or AP(Router) companies.

- 2 Select the **NETWORK** → **Network Status** menu.



**When an ✓ appears on TV, Gateway and DNS, but an X on Internet.**

- 1 Unplug the power cord of the AP(Router), cable modem and try to connect after 5 seconds.
- 2 Initialize(Reset) the AP(Router) or cable modem.
- 3 Check that the MAC address of the TV/AP(Router) is registered with your Internet service provider. (The MAC address displayed on the right pane of the network status window should be registered with your Internet service provider.)
- 4 Check the AP(Router) manufacturer's website to make sure your router has the latest firmware version installed.

Follow the instructions below that correlate to your network status.

**Check the TV or the AP(Router).**



**When an ✓ appears on TV, but an X on Gateway.**

- 1 Check the connection status of the TV, AP(Router) and cable modem.
- 2 Power off and power on the TV, AP(Router) and cable modem.
- 3 If you are using a static IP, enter the IP directly.
- 4 Contact internet companies or AP(Router) companies.
  - Additional points to check when using a wireless connection
    - 1 Check the password for the wireless connection in the AP(Router) settings window.
    - 2 Change the AP(Router) SSID (network name) or the wireless channel.



## SmartShare PC SW Installation & Setting

ENGLISH

Install the **SmartShare PC SW(DLNA)** and **SmartShare PC SW(MediaLink)** program on your PC.

- 1 Go to **www.lg.com**. Then, select your region.
- 2 Select **SUPPORT**. Then, search for your model.
- 3 Select **Drivers & Software** or **SOFTWARE UPDATE**. Then, select **SmartShare PC SW(DLNA)**
- 4 You can run the program when installation is complete.



### NOTE

- DLNA service is only available if TV and other devices are connected via a single AP(Router).

## DLNA Connection to Smartphone

- 1 Check that Wi-Fi is enabled on your smartphone. To use DLNA, both devices must be on the same local network.
- 2 Install/run the app for sharing content on your smartphone (It's called SmartShare on LG phones).
- 3 Enable your smartphone to share content files with other devices.
- 4 Select the file type you want to play (movie, audio or photo).
- 5 Select a movie, music or photo file to play on the TV.
- 6 Add the selected file to the playlist.
- 7 Select a TV model name on which to play the files. (The TV model name is on a label on the side of the TV and in the customer support menu.)
- 8 Play the media file to view and enjoy it on your TV.

## Updating the TV Firmware

HOME →  Settings → SUPPORT → Software Update

By default, the TV will notify you of new software updates. You can use the Software Update menu to manually check for available updates.

<b>Software Update</b>	Set it to <b>On</b> . When an updated file is detected, the file is downloaded automatically.
<b>Automatic Update Mode</b>	If an update is available, the update automatically starts without prompting.
<b>Check Update Version</b>	Checks the latest update version installed. When a new update is available, the download process can be performed manually.

## Tag On

(Depending on model)

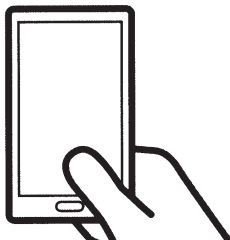

**Tag On**

Tag On is a data transmission technology that can be used on smartphones with NFC (Near Field Communication). Simply by tapping your smartphone to a Tag On sticker, you can share content between your smartphone and TV.

- **To connect your smartphone to the TV using Tag On, they must be connected on the same Wi-Fi network or Miracast™/Intel's WiDi of the smart TV is set to On.**

- Do not attach the sticker to a metal part of the TV. Otherwise, your smartphone cannot recognize the Tag On sticker.
- Do not crumple or fold the Tag On sticker. Otherwise, the Tag On is not recognized.
- To purchase a Tag On sticker, please contact the LG Electronics Service Center.
- This function is supported only on a smartphone with Android 4.0 (ICS) or later.

## Wi-Fi Direct Setting

ENGLISH

HOME →  Settings → NETWORK → Wi-Fi Direct

If a local network is not available, you can connect a portable device directly to the TV using Wi-Fi Direct. With Smart Share, you can share files or screens of devices connected to **Wi-Fi Direct**.

[Device Screen]



[TV Screen]

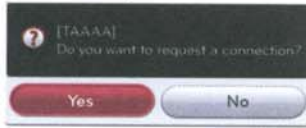

- 1 If **Wi-Fi Direct** is set to **On**, a list of available devices appears.
  - » To use **Wi-Fi Direct**, go to  **Settings** → **NETWORK** and set **Wi-Fi Direct**(**a**) to **On**.
- 2 When you are prompted to request connection, select **Yes**. **Wi-Fi Direct** is now connected to your TV.

\*If you are not using **Wi-Fi Direct** to minimize the interference between Wi-Fi devices, it is recommended to set **Wi-Fi Direct**(**a**) to **Off**. You can only use devices that support **Wi-Fi Direct**.

## Miracast™ Setting

Miracast allows a portable device to securely send video and sound to the TV wirelessly.

[Device Screen]



- 1 Miracast should be set to 'ON' on your mobile device And TV. Go to the Network settings to set the Miracast.
- 2 When your TV or portable device is detected, select the device.

## WiDi (Wireless Display) Setting

Intel's WiDi (Wireless Display) technology enables easy and fast connection without wires or internet network for mirrored and dual monitor display on your TV. You can sit back and experience your favorite movies, videos, photos, online shows and more in full HD on your TV with great image clarity and sound.

### NOTE

- When you connect the TV and laptop, you should set up TV mode for "Live TV" and "external input". If not, your computer cannot detect LG Smart TV.

- Intel's WiDi is set to On. Connect your laptop to AP(Router). (Without AP, it is possible to use this function; it is recommended to connect to AP.) Your laptop runs the Intel WiDi program.
- It detects LG Smart TVs available, which supports WiDi. In the list, select the TV you want and click Connect. Enter the number **(a)** shown on the screen into the input field **(b)** on your laptop and then click Continue. (4-digit number: under WiDi 3.1.29, 8-digit number: above WiDi 3.5)



[TV Screen]



[Notebook Screen]

- The TV screen appears on the laptop screen. The wireless environment may affect the screen display. If the connection is poor, the Intel WiDi connection may be lost.
- LG TVs do not need to register.
  - TV sound setting for **Digital Sound Out** is set to **PCM**.
  - For more information on Intel WiDi, visit '<http://intel.com/go/widi>'.
  - On the **Intel's WiDi**, WiDi device is not searched. Close the **Intel's WiDi**, then search WiDi.
  - You can control your PC using the Magic Remote Control.
  - Intel's WiDi laptop is not appeared in the Miracast /WiDi menu in TV network menu.



## On-Screen Remote

ENGLISH

**To use the Universal Control function (It may not be available depending on the country/model.)**

With the Magic Remote Control, you can easily control your set-top box, Blu-ray player, home theater system, and Sound Bar.

- 1 Check if the device is connected to the TV.
- 2 After pressing the '123 /Q.MENU' button on the Magic Remote Control, select the device you want to control in the Change Device tab. The Screen Remote that can control the device appears.

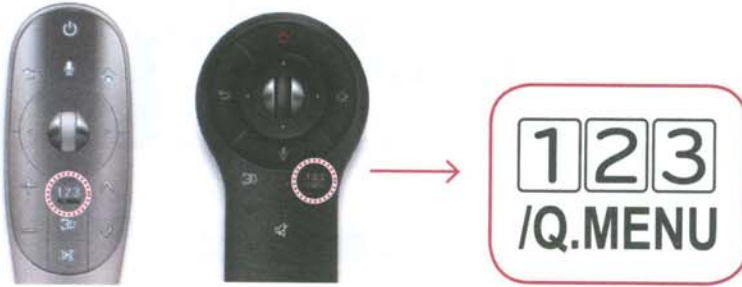

- 3 You can control external devices using the Screen Remote on the screen. (This may not work with the '123 /Q.MENU' button for some models.)



- » **a** : Change Device tab
- » **b** : Device control buttons
- » **c** : Expand the ScreenRemote
- » **d** : Exits the Screen Remote
- » **e** : Moves the position of the ScreenRemote to left or right

- 4 Control external devices using the navigation keys, wheel (OK), or BACK button on the Magic Remote Control.

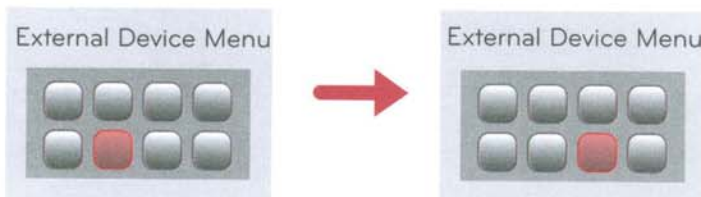

Please call LG Customer Service if you experience any problems.



# How to use the Magic remote control

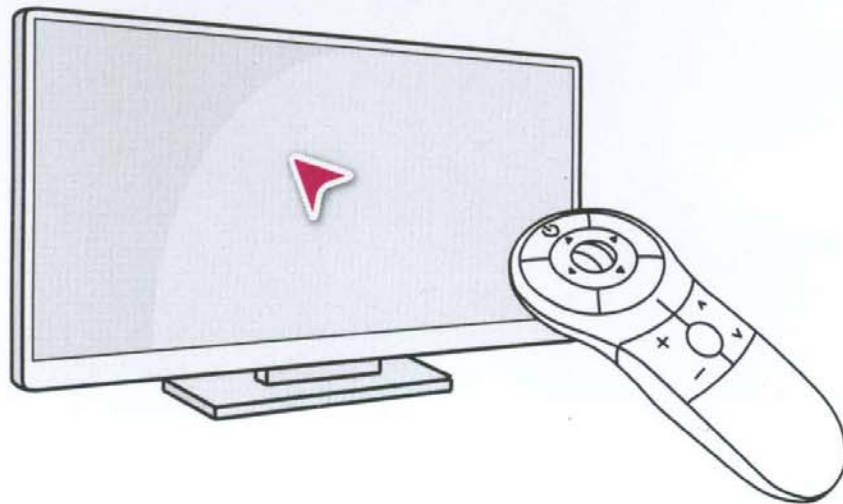

※ To use the Magic remote control, pair it with your TV first.

## How to register the Magic remote control



WHEEL

- 1 Put batteries into the Magic remote control and turn the TV on.
  - 2 Point the Magic remote control at your TV and press the WHEEL (OK) on the remote control.
- ♣ If the TV fails to register the Magic remote control, try again after turning the TV off and back on.

ENGLISH

## How to Re-register the Magic remote control



- Press the BACK and SMART at the same time, for five seconds, to unpair the Magic remote control with your TV.

## How to use the Magic remote control pointer

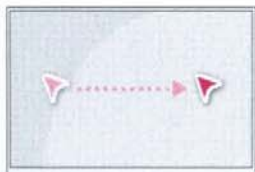

- Shake the Magic remote control slightly to the right and left or press SMART, SMART, or Q.MENU buttons to make the pointer appear on the screen.
- Shake the Magic remote control slightly to the right and left to make the pointer appear on the center of screen.
- If the pointer has not been used for a certain period of time, it will disappear.



## How to use the Magic remote control tip

- The wheel also functions as the 'OK' button when pressed.
- You can change channels and scroll through menus using the Wheel.
- You can just move your wrist to move the pointer instead of moving your whole arm.
- The Magic remote control depletes batteries faster than a normal remote due to the additional features. You may wish to use rechargeable batteries.
- If the pointer loses its calibration, set down the remote for a couple of minutes to let it recalibrate. Or you can re-register the remote.

※ Image shown may differ from your product.

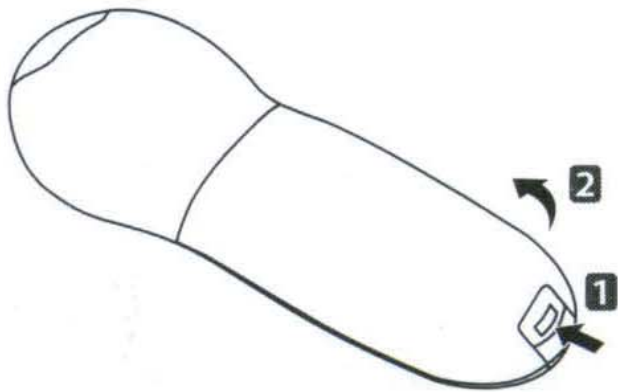

## Installing Batteries

- Press the end of the battery cover, slide it back and lift the cover as shown below.



**LG**

Life's Good

P/NO : MBM51168889(1301-REV01)



# Magic Remote User Information

Model Name: AN-MR400G

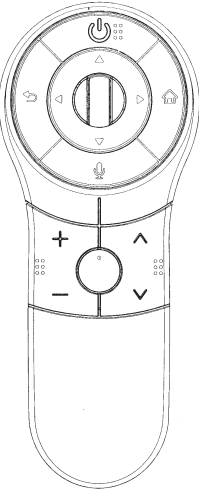

KOREAN

한국어

## 목 차

- 리모컨의 개요 및 제한
  - 개요
  - 제한
- 주의 사항
- 고객 지원

## 1. 리모컨의 개요 및 제한

- (1) 개요  
리모컨은 사용자가 벽에서 리모컨을 무선 마우스처럼 사용하여 TV를 제어할 수 있는 제품으로써, 기존 직외선 리모컨이 육안상 위치를 확인할 수 없었던 반면에 최대 10m 이내에서 방향에 상관없이 제어할 수 있는 2.4 GHz RF 리모컨이다.(음성인식지원)
- (2) 제한

구분	내용
모델명	AN-MR400G
주파수 대역	2.400 GHz ~ 2.4835 GHz
채널	79 채널
송신 출력	10 dBm
수신 감도	-86 dBm
크기	폭 56.4 x 두께 33.2 x 길이 135.5 (공차 ± 1 mm)
무게	66.6 g ± 5 g (건전지 포함하지 않음)
전원	AA 1.5 V, 2필 알칼리 건전지 2개 사용
동작 온도	0 °C ~ 60 °C

## 2. 주의 사항

- 건전지를 교제한 후에는 리모컨 사용법에 따라 페어링 후에 사용한다.
- 건전지를 교체 후 동작하지 않는다면, 건전지를 제거 후 사용법에 따라 페어링을 재시도한다.
- 장기간 리모컨을 사용하지 않는 경우, 건전지를 제거해 두는 것이 좋다.
- 건전지를 분해하거나, 열을 가해서는 안된다.
- 건전지를 묶어서 떨어뜨리거나, 케이스가 손상될 정도로 극심한 충격을 주는 것은 안된다.
- 건전지를 물에 넣어서는 안된다.
- 건전지를 가꾸로 삼일시 폭발의 위험이 있다.
- 지정된 장소에 사용한 건전지를 폐기 한다.

- (1) Sumario
  - (2) Especificaciones
- ## 2. Precauciones
- ### 3. Soporte al cliente

## 1. Sumario y especificaciones del control remoto

- (1) Sumario  
Este control remoto es un producto para controlar la TV usándolo como un ratón inalámbrico dentro de la casa del usuario que, a diferencia de los controles remotos a rayo infrarrojo convencionales que controlaban los productos ubicados dentro del radio de la visión, es un control remoto RF de 2.4 GHz que puede controlar dentro de un radio de 10 m sin importar la dirección.(Reconocimiento de voz de apoyo)
- (2) Especificaciones

Item	Contenido
Modelo	AN-MR400G
Banda de frecuencia	2.400 GHz ~ 2.4835 GHz
Canal	79 canales
Salida de transmisión	10 dBm
Grado de recepción	-86 dBm
Dimensiones	Ancho 56.4 x espesor 33.2 x largo 135.5 (Dif. ± 1 mm)
Peso	66.6 g ± 5 g (sin las pilas)
Energía	AA 1.5 V, 2 pilas alcalinas
Temperatura de operación	0 °C ~ 60 °C

## 2. Cuidados

- después de colocar las pilas, hay que emparejar el mando con el televisor de acuerdo con las instrucciones.
- si no funciona después de colocar las pilas, reintente emparejar el mando.
- si no utiliza el control remoto por un tiempo prolongado, es recomendable quitar las pilas.
- no desarme las pilas ni aplique calor.
- no deje caer las pilas ni golpee la caja para evitar dañarla
- no sumerja las pilas en agua
- no coloque las pilas al revés ya que hay peligro de explosión.
- desheche las pilas usadas en los lugares establecidos.

## 3. Soporte al cliente

Vea las direcciones y los teléfonos de servicio en el manual de la TV.

## 3. 고객 지원

TV 매뉴얼의 서비스 연락처를 참조하십시오.  
[KCC 인증 마크 및 인증번호]



상호명: 엘지전자(주)  
인증번호: KCC-CRM-LGE-MR400G  
제조연월: 2013.  
제조사/제조국가: 엘지전자(주)/대한민국  
기자재의 명칭/모델명: 특정소속력 무선기(가운데이더통신시스템용 무선기)/AN-MR400G

ENGLISH

## Table of Contents

- Overview and specification of the remote control
  - Overview
  - Specification
- Precautions
- Customer Support

## 1. Overview and Specifications for the Remote Control

- (1) Overview  
- this remote uses RF(Radio Frequency) instead of IR (Infrared light), this remote will operate within 10m of the tv and does not require it be pointed at the tv.(voice recognition support)

## (2) Specifications

Categories	Details
Model No.	AN-MR400G
Range of frequency	2.400 GHz ~ 2.4835 GHz
Channel	79 channels
Transmission output	10 dBm
Reception sensitivity	-86 dBm
Dimensions	Width 56.4 x Thickness 33.2 x Length 135.5 (tolerance of ± 1 mm)
Weight	66.6 g ± 5 g (excluding battery)
Power source	AA 1.5 V, 2 alkaline batteries are used
Operational temperature range	0 °C ~ 60 °C

SIMPLIFIED CHINESE

中文简体

## 目 录

- 遥控器的概要及所有因素
  - 概要
  - 所有因素
- 注意事项
- 客户服务

## 1. 遥控器的概要及所有因素

- (1) 概要  
-该遥控器为用户可在家里仿佛 使用无线鼠标遥控电视的产品,相比现有红外线遥控器只可调控位于肉眼可见到的范围内产品,该遥控器是可以调控家里10m以内,并且从任何方向都可调控2.4 GHz 范围内电视的RF遥控器。(支持语音识别)

## (2) 所有因素

區分	內容
型号名称	AN-MR400G
频率范围	2.400 GHz ~ 2.4835 GHz
频道	79 频道
输出功率	10 dBm
灵敏度	-86 dBm
大小	宽度 56.4 x 厚度 33.2 x 长度 135.5 (公差±1 mm)
重量	66.6 g ± 5 g (不包括干电池)
电源	AA 1.5 V, 2 使用 2 个碱性干电池
动作温度	0 °C ~ 60 °C

## 2. 注意事項

- 更換電池后,請在根據遙控器使用方法調配后使用。
- 更換電池后如無法正常使用,請在取下電池后再次做好調配。
- 長期停止使用遙控器時,最好取下電池。
- 不得將電池或對電池加熱。
- 不得將電池或施加可能造成電子受損程度的嚴重沖擊。
- 不得將電池放入水中。

## 2. Precautions

- After replacement of the battery, use the remote control following pairing in accordance with user manual.
- If the unit does not operate after replacement of battery, take the battery out and reattempt pairing in accordance with the user manual.
- If the remote controller is not being used for prolonged period of time, it is recommended you remove the battery from the unit.
- Do not dismantle or exert heat to the battery.
- Do not drop battery or exert extreme impact that may even cause the case to be damaged.
- Do not immerse the battery in water.
- There is danger of explosion if a battery is inserted reversely.
- Properly dispose of used batteries.

## 3. Customer Support

Refer to the contact number for services provided in the TV Manual.

GERMAN

DEUTSCH

## Inhalt

## 1. Beschreibung und technische Spezifikation der Fernbedienung

- Beschreibung
- Technische Spezifikation

## 2. Warnhinweise

- (1) Beschreibung  
Die Fernbedienung kann wie eine schnurlose Maus verwendet werden um den Fernseher zu bedienen. Im Gegensatz zu herkömmlichen Fernbedienungen mit denen der Fernseher nur aus kurzer Distanz bedient werden kann, kann man mit dieser RF Fernbedienung mit ihrem 2.4 GHz Frequenzbereich den Fernseher von irgendeiner beliebigen Richtung aus in Ihrem Haus und bei einem Abstand von bis zu 10 m bedienen. (Voice Recognition Unterstützung)

## (2) Technische Spezifikation

Kategorie	Details
Modell	AN-MR400G
Frequenzbereich	2.400 GHz ~ 2.4835 GHz
Kanal	Kanal 79
Sendeleistung	10 dBm
Empfängerleistung	-86 dBm

- 电池反过来插入时,有发生爆炸的危险。
- 干电池要废弃到指定场所。

## 3. 客户服务

請參照TV說明書的服務聯絡處。

TRADITIONAL CHINESE

中文繁體

## 目 錄

- 遙控器概要說明與規格表
  - 概要說明
  - 規格表
- 注意事項
- 客戶服務

## 1. 遙控器概要說明與規格表

- (1) 概要  
-無線接收器讓用戶在家享有使用無線滑鼠般的無線遙控電視,相較現有的紅外線遙控器僅能控制在肉眼可視範圍內,此無線遙控器遙控範圍在家中10公尺以內,從任何方向均能操控手中的遙控器。(此遙控器支援語音識別功能)

## (2) 規格表

區分	內容
型號名稱	AN-MR400G
頻率範圍	2.400 GHz ~ 2.4835 GHz
頻道	79 頻道
輸出功率	10 dBm
靈敏度	-86 dBm
大小	寬度 56.4 x 厚度 33.2 x 長度 135.5 (公差±1 mm)
重量	66.6 g ± 5 g (不包括乾電池)
電源	AA 1.5 V, 2 使用 2 個鹼性乾電池
動作溫度	0 °C ~ 60 °C

Größe	Breite 56.4 x Höhe 33.2 x Länge 135.5 (Abweichung ± 1 mm)
Gewicht	66.6 g ± 5 g (ohne Batterien)
Energiequelle	AA 1.5 V, 2 Alkali-Batterien werden benötigt.
Arbeitstemperatur	0 °C ~ 60 °C

## 2. Warnhinweise

- Nachdem Sie die Batterie ausgetauscht haben, verwenden Sie die Fernbedienung der Beschreibung folgend.
- Wenn die Fernbedienung nach dem Batteriewechsel nicht funktioniert, nehmen Sie die Batterien nochmal heraus und setzen Sie sie ordnungsgemäß ein.
- Wenn Sie die Fernbedienung für längere Zeit nicht benutzen, ist es besser die Batterien herauszunehmen.
- Entzerlen und erhitzen Sie die Batterien nicht.
- Lassen Sie die Batterien nicht fallen und üben Sie keinen übermäßigen Druck auf die Fernbedienung aus.
- Die Batterien sollen keinen Kontakt mit Wasser haben.
- Es besteht Explosionsgefahr wenn Sie die Batterien verkehrt einsetzen.
- Entsorgen Sie die Batterien an einem dafür vorgesehenen Ort.

## 3. Kundendienst

Die Kundendienst Rufnummer finden Sie in der Bedienungsanleitung des Fernsehers.

FRENCH

FRANÇAIS

## Table des matières

- Aperçu et spécifications de la télécommande
  - Aperçu
  - Spécifications
- Précautions d'emploi
- Support client

## 1. Aperçu et spécifications de la télécommande

- (1) Aperçu  
Cette télécommande vous permet de contrôler votre téléviseur en l'utilisant comme une souris sans fil. Avec cette télécommande qui utilise la radiofréquence 2.4GHz, contrôlez votre écran jusqu'à une portée de 10m (reconnaissance vocale incluse).

## 2. 注意事項

- 更換電池後,請同時參照遙控器的說明文件。
- 更換電池後若無法正常使用,請將電池拔除後再次裝上。
- 若長時間不使用遙控器,請取下電池。
- 請勿自行拆解電池本體或對電池加熱。
- 電池脫落或使力過大將造成遙控器蓋受損。
- 請勿將產品浸水。
- 電池倒反插時,有可能造成爆炸的危險。
- 廢棄電池請回收到指定地點。

## 3. 客戶服務

請參照TV說明書內的服務聯絡電話。

RUSSIAN

РУССКОЕ

## Содержание

- Краткое описание и технические параметры Дистанционного пульта управления
  - Краткое описание
  - Технические параметры
- Меры предосторожности
- Техническая поддержка

## 1. Краткое описание и технические параметры дистанционного управления

- (1) Краткое описание  
-Данный дистанционный пульт управления может быть использован для управления телевизором подобно беспроводной мыши для компьютера, имеет радиочастоту 2.4 ГГц и в отличие от прежних моделей инфракрасных пультов, которые позволяли управлять только в пределах видимости, эта модель позволяет управлять в любом направлении в доме в радиусе 10 метров (поддержка функции распознавания голоса).

## (2) Технические параметры

Название	Содержание
Название модели	AN-MR400G
Диапазон радиочастот	2.400 GHz ~ 2.4835 GHz
Каналы	79 каналов
Мощность сигнала	10 ДБМ

## (2) Specifications

Catégorie	Contenu
Nom de modèle	AN-MR400G
Zone de fréquences	2.400 GHz ~ 2.4835 GHz
Chaîne	79 chaînes
Puissance pour l'envoi	10 dBm
Réceptivité	-86 dBm
Dimensions (mm)	56.4 (L) x 33.2 (L) x 135.5 (E) (tolérances ± 1)
Poids (g)	66.6 ± 5 (non incluant les piles)
Secteur	AA 1.5 V, 2 piles alcalines
Température de fonctionnement	0 °C à 60 °C

## 2. Précautions

- Après avoir changé de batterie, procédez à la synchronisation de la télécommande en suivant le mode d'emploi.
- Si la télécommande ne fonctionne pas même après avoir changé de batterie, enlevez cette dernière, puis essayez à nouveau l'appareil suivant le mode d'emploi.
- En cas de non utilisation de la télécommande pendant une longue période, il vaut mieux enlever la batterie.
- Ne pas laisser les piles près d'une source de chaleur
- Ne faites pas subir de choc à la télécommande, cela pourrait endommager son boîtier et son fonctionnement.
- Ne pas mettre les piles dans de l'eau
- Vous introduisez les piles à l'envers il y a un risque de détérioration ou d'explosion
- Les piles usées doivent être jetées dans un endroit adapté

## 3. Support client

Veillez consulter les coordonnées du service après-vente dans le manuel de la télévision.

PORTUGUESE

PORTUGUES

## Índice

- Introdução e especificações do controle remoto
  - Introdução
  - Especificações
- Cuidados
- Soporte ao Cliente

Чувствительность сигнала	-86 дБм
Размеры	Ширина 56.4x Толщина 33.2 x Длина 135.5 (допуск ± 1мм)
Вес	66.6 гр. ± 5 гр (без батареек)
Источник питания	AA 1.5 V, щелочные батарейки 2 шт
Рабочая температура	0 °C ~ 60 °C

## 2. Меры предосторожности:

- При замене батарей необходимо следовать инструкции по применению пульта дистанционного управления.
- Если пульт не работает после замены батарей, необходимо вытащить их и еще раз установить в соответствии с инструкцией.
- Если пульт не используется в течение длительного времени, необходимо вытащить батарейки.
- Не разбирайте и не подвергайте батареи воздействию высоких температур.
- Не подвергайте продукт излишнему механическому воздействию, которое может привести к повреждению продукта.
- Избегайте контакта батарей с водой.
- Если батареи установлены неправильно, существует опасность повреждения устройств.
- Использованные батареи необходимо выбрасывать в специально отведенные места.

## 3. Техническая поддержка

По вопросам эксплуатации изделия и сервисного обслуживания обращайтесь в службу поддержки клиентов по телефону, указанным в инструкции по эксплуатации телевизора.

Japanese

日本語

## 目 次

- リモコンの概要と仕様
  - 概要
  - 仕様
- 注意事項
- カスタマーサービス

## 1. リモコンの概要と仕様

- (1) 概要  
- マックリモコンは、ワイヤレスマウスのように使用してテレビを操作できます。従来の赤外線リモコンでは、テレビの受光部にリモコンを向けず操作する必要がありましたが、マックリモコンは、2.4GHz無線電波を使用した無線を使用することで、リモコンの向きを気にせずともテレビに接続することができます。(10m以内の距離で操作することが可能です。音声認識機能もサポートしています。)

## 1. Introdução e especificações do controle remoto

- (1) Introdução  
Este control remoto é um produto similar a um rato sem-fios que permite controlar a TV. Difere dos outros teclados que podem apenas controlar os aparelhos em seu redor, este control remoto de 2.4GHz RF, por sua vez, pode controlá-los, sem limitação, dentro de um raio de 10m. (Suporte de reconhecimento de voz)

## (2) Especificações

Item	Conteúdo
Nome do Modelo	AN-MR400G
Banda de Frequência	2.400 GHz ~ 2.4835 GHz
Canais	79 canais
Saída de Transmissão	10 dBm
Sensibilidade de Recepção	-86 dBm
Tamanho	L 56.4 x E 33.2 x A 135.5 (tolerância ± 1 mm)
Peso	66.6 g ± 5 g (sem baterias)
Alimentação	AA 1.5 V, utiliza-se 2 pilhas alcalinas
Temperatura de uso	0 °C à 60 °C

## 2. Cuidados

- Após troca de pilhas deve emparelhar novamente o comando com a televisão, de acordo com o manual do aparelho.
- Se o comando remoto não funcionar após a troca de pilhas, remova-as e tente novo emparelhamento de acordo com o manual do control remoto.
- Se não utilizar o control remoto por alargados períodos é recomendado remover as pilhas.
- Não desmonte ou aqueça as pilhas.
- Não deixe cair as pilhas ou que estão sofram qualquer impacto forte.
- Não molhe as pilhas.
- Perigo de explosão se colocar as pilhas na posição errada.
- Coloque as pilhas em local recomendado.

## 3. Soporte ao Cliente

Ver dados para contato impresso no Manual de TV.

SPANISH

ESPAÑOL

## Índice

### 1. Sumario y especificaciones del control remoto



カテゴリ	詳 細
モデル番号	AN-MR400G
周波数の範囲	2.400 GHz ~ 2.4835 GHz
チャンネル	79 チャンネル
送信出力	10 dBm
受信感度	-86 dBm
寸法	幅56.4x厚33.2x長さ135.5 (±1mmの公差)
重さ	66.6 g (±0.9 g) (バッテリーを除く)
パワーソース	AA 1.5 V
動作温度範囲	2アルカリ電池2個使用 0℃ ~ 60℃

## 2. 注意事項

- 指定以外の乾電池は使用しないでください。
- 電池の交換後に、テレビを操作できない場合はマジックリモコンの取扱説明書に従ってペアリングを行ってください。
- マジックリモコンを長期間使用しないときは乾電池の消耗を少なくするために、乾電池を取り出しておいてください。
- 家内での使用を推奨期間に過ぎた乾電池や使い切った乾電池はマジックリモコンに入れておかないでください。
- 傷ついたり、変形、液漏れした乾電池を使用しないでください。
- 小さなお子様が使用される場合、乾電池のセトおよび取り出しは、保護者の方が行ってください。
- 極端な温度条件下で保管しないでください。
- 強い衝撃を与えないでください。
- 乾電池を廃棄するときは地域の条例に従ってください。

### 3. カスタマーサービス

※本紙の別項目に記載されたカスタマーサポートセンターの連絡先を参照してください。

## Regulation

### (1) KCC Statement(韓国)

"제작자 및 설치자는 해당 무선설비가 전파전자파를 일으키므로 인명안전과 관련된 지시는 할 수 없음"

### (2) NCC Statement(Taiwan)

根據NCC低功率電波輻射性電機管理辦法規定
1)第十二條
經型式認證合格之低功率射頻電機，非經許可，公司、商號或使用者均不得擅自變更頻率、加大功率或變更原設計之特性及功能

direktör.

R&TTE direktiva 1999/5/EC

De produktter, der er beskrevet ovenfor, overholder de vigtigste krav i de angivne direktiver.

Europæisk repræsentant: LG Electronics Inc. Krijgsman 1, 1186 DM Amstelveen, Holland

### (6-12) SUOMI

**EU-vaatimustenmukaisuusilmoitus**: LG Electronics vakuuttaa täten, että tämä tuote on seuraavien direktiivien mukainen:

R&TTE-direktiivi 1999/5/EC

Edellä mainitut tuotteet ovat eritellyjen direktiivien ollenstien vaatimusten mukaisia.

Edustaja Euroopassa: LG Electronics Inc. Krijgsman 1, 1186 DM Amstelveen, Alankomaat

### (6-13) EESTI

**EÜ vastavuskiinitus**: Käesolevaga kinnitab LG Electronics, et see toode ühildub järg-miste direktiividega..

Raadioseadmete ja telekommunikatsioonivõrgu lõppeadmete direktiiv 1999/5/EÜ

Eelnimetatud tooted vastavad märgitud direktiivide olulistele nõuetele.

Euroopa esindus: LG Electronics Inc. Krijgsman 1, 1186 DM Amstelveen, Holland

### (6-14) LIETUVIŲ K

**EB atitikties deklaracija**: „LG Electronics“ pareiškia, kad šis produktas atitinka tokias direktyvas.

R&TTE direktiva 1999/5/EB

Aukščiau įvardinti produktai atitinka nurodytų direktyvų esminius reikalavimus.

Atstovas Europoje: LG Electronics Inc. Krijgsman 1, 1186 DM Amstelveen, Nyderlandai

### (6-15) LATVIĒS

**Paziņojums par atbilstību ES direktīvam**: LG Electronics ar šo paziņo, ka šis izstrādājums atbilst turpmāk minētajām direktīvam.

### 2) 第十四條

低功率射頻電機之使用不得影響飛航安全或干擾合法通信；經發現有干擾現象時，應立即停用，並改善至無干擾時方得繼續使用。前項合法通信，指依電法規定作業之無線電通信。低功率射頻電機須忍受合法通信或工業、科學及醫療用電波輻射性電機設備之干擾。

### (3) ANATEL Statement (Para Brazil)

Este equipamento opera em caráter secundário, isto é, não tem direito à proteção contra interferência prejudicial, mesmo de estações do mesmo tipo e não pode causar interferência a sistemas operando em caráter primário.

### (4) Federal Communications Commission(FCC) Statement

You are cautioned that changes or modifications not expressly approved by the part responsible for compliance could void the user's authority to operate the equipment. This equipment has been tested and found to comply with the limits for a Class B digital device, pursuant to part 15 of the FCC rules.

These limits are designed to provide reasonable protection against harmful interference in a residential installation. This equipment generates, uses and can radiate radio frequency energy and, if not installed and used in accordance with the instructions, may cause harmful interference to radio communications. However, there is no guarantee that interference will not occur in a particular installation. If this equipment does cause harmful interference to radio or television reception, which can be determined by turning the equipment off and on, the user is encouraged to try to correct the interference by one or more of the following measures:

- Reorient or relocate the receiving antenna.
- Increase the separation between the equipment and receiver.
- Connect the equipment into an outlet on a circuit different from that to which the receiver is connected
- Consult the dealer or an experienced radio/TV technician for help.

This device complies with Part 15 of the FCC Rules. Operation is subject to the following two conditions:

- 1) this device may not cause harmful interference, and
- 2) this device must accept any interference received, including interference that may cause undesired operation of the device.

### FCC Caution

Any changes or modifications not expressly approved by the party responsible for compliance could void the user's authority to operate this equipment. For and/or use only, use outdoors or in other modes not covered by this manual may violate the FCC regulation and violate the user authority to use the product.

### FCC RF Radiation Exposure Statement:

This equipment complies with FCC radiation exposure limits set forth for an uncontrolled environment. End users must follow the specific operating instructions for satisfying RF exposure compliance.

### (5) Industry Canada(IC) Statement

This device complies with RSS-210 of the Industry Canada Rules. Operation is subject to the following two conditions:
1) this device may not cause interference and
2) this device must accept any interference.
Including interference that may cause undesired operation of device.

### Avis d'Industrie Canada

Cet appareil est conforme à norme CNR-210 des règlements d'Industrie Canada. Son fonctionnement est sujet aux deux conditions suivantes:
1) Cet appareil ne doit pas provoquer d'interférences et
2) Cet appareil doit accepter toutes les interférences, y compris celles pouvant entraîner son dys-fonctionnement.

### IC Radiation Exposure Statement:

This equipment complies with IC radiation exposure limits set forth for an uncontrolled environment.

NOTE: THE MANUFACTURER IS NOT RESPONSIBLE FOR ANY RADIO OR TV INTERFERENCE CAUSED BY UNAUTHORIZED MODIFICATIONS TO THIS EQUIPMENT.

SUCH MODIFICATIONS COULD VOID THE USER'S AUTHORITY TO OPERATE THE EQUIPMENT.

### Avis d'Industrie Canada sur l'exposition aux rayonnements

Cet appareil est conforme aux limites d'exposition aux rayonnements d'Industrie Canada pour un environnement non contrôlé.

REMARQUE: LE FABRICANT N'EST PAS RESPONSABLE DES INTERFÉRENCES RADIOÉLECTRIQUES CAUSÉES PAR DES MODIFICATIONS NON AUTORISÉES APPORTÉES À CET APPAREIL. DE TELLES MODIFICATIONS POURRAIT ANNULLER L'AUTORISATION ACCORDÉE À L'UTILISATEUR DE FAIRE FONCTIONNER L'APPAREIL.

### COFETEL(Mexico)

La operación de este equipo está sujeta a las siguientes dos condiciones:

- (1) es posible que este equipo o dispositivo no cause interferencia perjudicial y
- (2) este equipo o dispositivo debe aceptar cualquier interferencia, incluyendo la que pueda causar su operación no deseada.

### (6) CE Statement

1) CE conformity Notice
LG Electronics hereby declares that this product is in compliance with the following Directives.
R&TTE Directive 1999/5/EC

The products described above comply with the essential requirements of the directives specified. This device is a 2.4 GHz wideband transmission system, intended for use in all EU member states and EFTA countries
European representative: LG Electronics Inc. Krijgsman 1, 1186 DM Amstelveen, The Netherlands

### 2) CE Notified Body statement:

This is a Class B product. In a domestic environment, this product may cause radio interference, in which case the user may be required to take adequate measures. Explosive device proximity warning – Do not operate a portable transmitter (such as a wireless network device) near unshielded blasting caps or in an explosive environment unless the device has been modified to be qualified for such use.
This CE marking is valid for EU non-harmonized telecommunications products and R&TTE Directive (1999/5/EC) issued by the Commission of the European Community.

## 3) Certification Marking

# CE 0197

### (6-1) DEUTSCH

**EU-Konformitätserklärung**: LG Electronics erklärt hiermit, dass dieses Produkt den folgenden Richtlinien entspricht:
R&TTE-Richtlinie 1999/5/EC

Die oben beschriebenen Produkte entsprechen den grundlegenden Anforderungen der angegebenen Richtlinien.

Vertreter für Europa: LG Electronics Inc. Krijgsman 1, 1186 DM Amstelveen, Niederlande

### (6-2) FRANÇAIS

**Notice de conformité UE**: LG Electronics atteste que ces produits est en conformité avec les Directives suivantes.

Directve 1999/5/CE R&TTE

Les produits décrits ci-dessus sont en conformité avec les exigences essentielles des directives spéci-fiées.

Representant en Europe : LG Electronics Inc. Krijgsman 1, 1186 DM Amstelveen, Pays-Bas

### (6-3) ITALIANO

**Avviso di conformità UE**: LG dichiara che questo prodotto è conforme alle seguenti direttive.

Direttiva R&TTE 1999/5/CE

I prodotti descritti sopra sono conformi ai requisiti essenziali delle direttive specificate.

Rappresentante europeo: LG Electronics Inc. Krijgsman 1, 1186 DM Amstelveen, Paesi Bassi

### (6-4) ESPAÑOL

**Aviso de conformidad con la UE**: Por la presente, LG Electronics declara que este producto cumple con las siguientes directivas.

Directiva sobre equipos radioeléctricos y equipos terminales de telecomunicación 1999/5/CE

Los productos descritos anteriormente cumplen con los requisitos esenciales de las directivas específicas.

Rrepresentante europeo: LG Electronics Inc. Krijgsman 1, 1186 DM Amstelveen Países Bajos

### (6-5) PORTUGUÊS

**Aviso de conformidade da UE**: A LG Electronics declara por este meio que este produto está em conformidade com as seguintes Diretivas.

Directiva R&TTE 1999/5/CE

Os produtos acima descritos estão em conformidade com os requisitos essenciais das directivas espe-cíficas.

Rrepresentante europeo: LG Electronics Inc. Krijgsman 1, 1186 DM Amstelveen Holanda

### (6-6) NEDERLANDS

**Conformiteitsverklaring (EU)**: LG verklaart hierbij dat dit product voldoet aan de volgende richtlijn.

R&TTE-richtlijn 1999/5/EC

De hierboven genoemde producten voldoen aan de essentiële voorwaarden van de gespecificeerde richtlijn(en).

Europees hoofdkantoor: LG Electronics Inc. Krijgsman 1, 1186 DM Amstelveen Nederland

Vyšje popisované produkty jsou v souladu se základními požadavky uvedených směrníc.
Zastoupení v Evropě: LG Electronics Krijgsman 1, 1186 DM Amstelveen, Nizozemsko

## (6-28) SLOVENSKY

**Vyhlasenie o zhode pre oblasti EU**: Spoločnosť LG Electronics týmto vyhlasuje, že tento výrobok dosahuje súlad s nasledujúcimi smernicami.
Smernica R&TTE 1999/5/ES

Vyššie popísané výrobky vyhovujú základným požadavkám uvedených smerníc.

Europské zastupitelstvo: LG Electronics Krijgsman 1, 1186 DM Amstelveen, Holandsko

### (6-29) ROMANESTE

**Declarat** ie de conformitate UE: Prin prezenta, LG Electronics declara" ca" acest produs este conform cu urma"toarele Directive.

Directiva R&TTE 1999/5/CE

Produsul descris mai sus este conform cu cerint, ele esent, iale ale directivei specificate.
Representant european: LG Electronics Krijgsman 1, 1186 DM Amstelveen, Olanda

### (6-30) БЪЛГАРСКИ

**Бележка относно съответствие с нормите на ЕС**: С настоящото LG Electronics декларира, че този продукт съответства на следните директиви.

R&TTE директива 1999/5/EC

Описаният по-горе продукт съответства на основните изисквания на посочените директиви.

Европейски представител: LG Electronics Krijgsman 1, 1186 DM Amstelveen, Нидерландия

### (7) Japan

**2.4 FH1** この表示のある無線機器は、2.4GHz帯を使用しています。支線方式としてFH-SS方式を採用し、与歩距離は10mです。

＜本製品の使用上の注意事項＞
この機器の使用周波数帯では、電子レンジ等の産業・科学・医療用機器のほか工場の製造ライン等で使用されている移動体識別用の構内無線局（免許を要する無線局）及び特定小電力無線局（免許を

**(6-7) ΕΛΛΗΝΙΚΑ**
**Διήση συμμόρφωσης E.E.**: Η LG Electronics δηλώνει ότι το παρόν προϊόν συμμορφώνεται με τις εξής Οδηγίες:

Οδηγία 1999/5/EK περί Ραδιοελευθέρων και Τηλεπικοινωνιακού Τεχνικού Εργασιολογίου (R&TTE)

Το παρόντος προϊόν συμμορφώνονται με τις οικολόγες απαιτήσεις των ανωτέρω οδηγιών.

Ευρωπαϊκό αντιπρόσωπο: LG Electronics Krijgsman 1, 1186 DM Amstelveen, Ολλανδία

### (6-8) MAGYAR

**EU megfelelőségi nyilatkozat**: AZ LG Electronics ezáltal kijelenti, hogy a termék megfelel a következő irányékv előírásának:

1999/5/EK R&TTE irányékv

A fentiekben bemutatott termékek teljesítki a megadott irányékv alapvető előírásait.

Európai képviselet: LG Electronics Krijgsman 1, 1186 DM Amstelveen, Hollandia

### (6-9) SVENSKA

**Medelande om EU-reglerfor europe**: LG Electronics intygar hermed att den här produkten oppfyller foljande gallande direktiv:

R&TTE-direktivét 1999/5/EG

Ovan nämnda produkter stämmer överens med de grundläggande kraven som anges i direktiven.

Europeisk representant: LG Electronics Inc. Krijgsman 1, 1186 DM Amstelveen, Nederländerna

### (6-10) NORSK

**Samsvarsmerknad for EU**: LG Electronics erklærer herved at dette produktet er i henhold til de følgende direktivene.

R&TTE-direktiv 1999/5/EC

Produktene som beskrives ovenfor, overholder kravene i de angitte direktivene.

Europeisk representant: LG Electronics Inc. Krijgsman 1, 1186 DM Amstelveen, Nederland

### (6-11) DANSK

**EU-oversensstemmelseserklæring**: LG Electronics erklærer hermed, at dette produkt overholder følgende

regeringsanbefalinger.
Více popisované produkty jsou v souladu se základními požadavky uvedených směrníc.

Zastoupení v Evropě: LG Electronics Krijgsman 1, 1186 DM Amstelveen, Nizozemsko

**(6-28) SLOVENSKY**
**Vyhlasenie o zhode pre oblasti EU**: Spoločnosť LG Electronics týmto vyhlasuje, že tento výrobok dosahuje súlad s nasledujúcimi smernicami.

Smernica R&TTE 1999/5/ES
Vyššie popísané výrobky vyhovujú základným požadavkám uvedených smerníc.
Europské zastupitelstvo: LG Electronics Krijgsman 1, 1186 DM Amstelveen, Holandsko

<p>LG Electronics Japan (株)カスタマーサポートセンター</p> <p><b>0120-813-023</b></p> <p><small>受付時間: 午前10時~午後5時(土・日・祭日を除く)</small></p> <p><small>受付時間: 午前9時~午後5時(土・日・祭日を除く)</small></p> <p><small>受付時間: 午前9時~午後5時(土・日・祭日を除く)</small></p> <p><small>TEL: 03-5675-7321</small></p>
---

(8) **Malaysia SIRIM Sticker**
**Place SIRIM label here**

## (10) Ukraine

ПІІ "ЛГ Електронікс Україна", Україна, 01004, м. Київ, вул. Басейна, 4 (пітера А), тел.: +38 (044) 201-43-50, факс: +38 (044) 201-43-73

## (12) Singapore

Complex with BSA Standards DB102260
TA-2012/1222
APPROVED

### [Specification]

- Model Name: AN-MR400G
- Batch/Serial No.: -
- Manufacturer: OHSUNG Electronics
- Brand: LG Electronics Inc.
- Product Name: Magic Remote



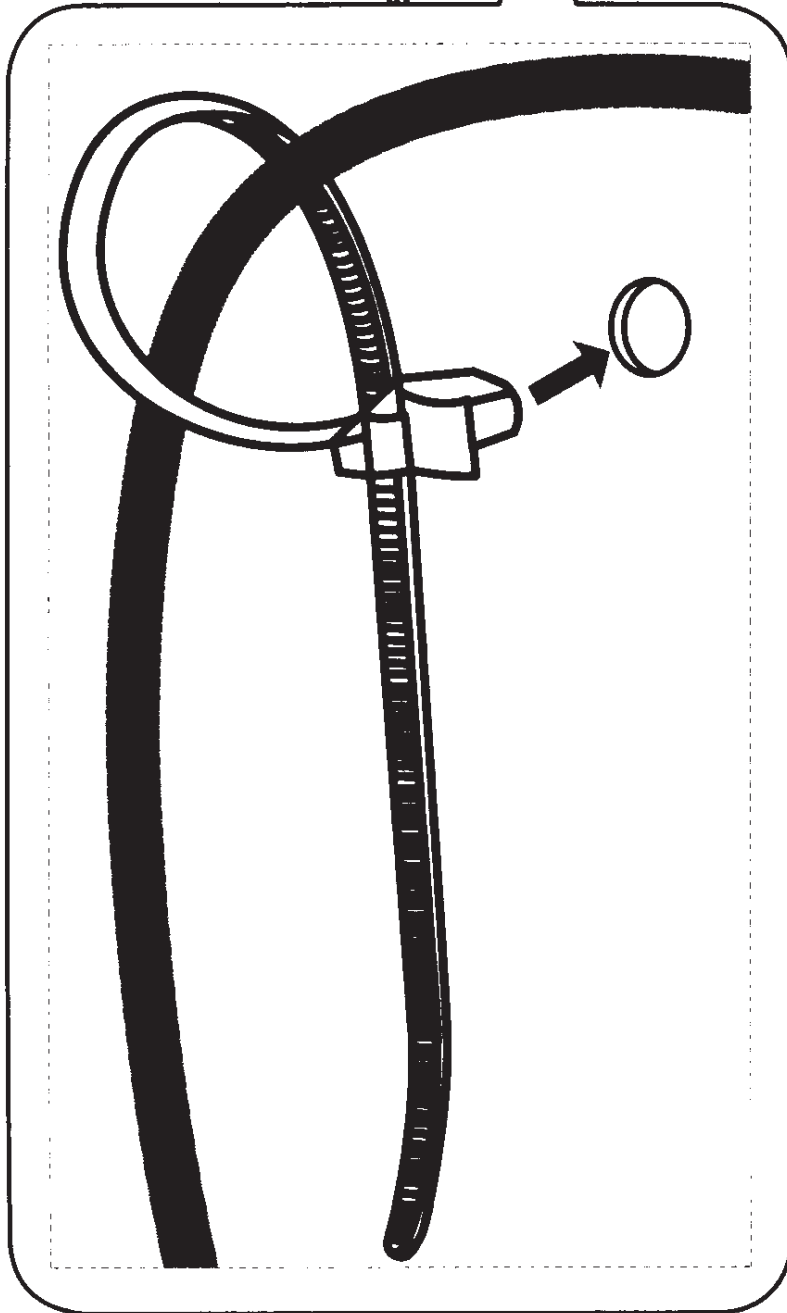
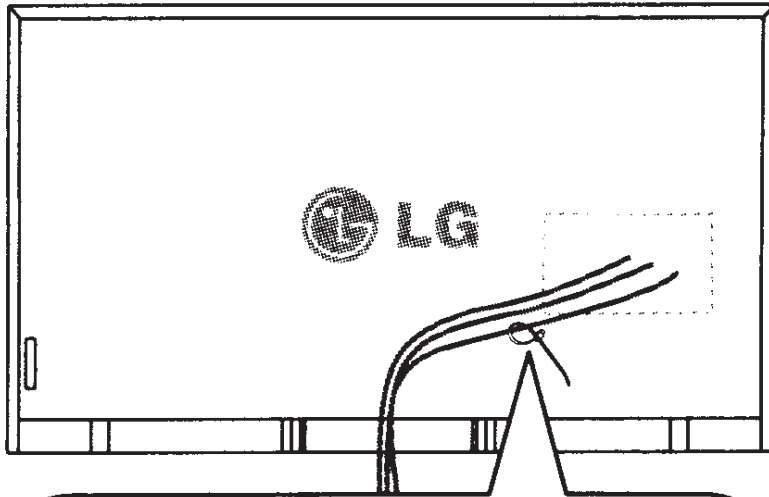

\* Please see the back for more information about the above pictures.

## English

To prevent damage to the coaxial cable connection port, attach the coaxial cable holder provided with the TV to the back of the TV. Insert the connected coaxial cable into the coaxial cable holder and tighten it in place. Make sure to attach cables separately to prevent damage to it, which may occur due to excessive movement.

## Français

Pour éviter d'endommager le port du câble coaxial, fixez le serre-câble fourni à l'arrière du téléviseur. Glissez le câble coaxial branché dans le serre-câble et serrez pour le maintenir en place. Veuillez également à fixer le câble coaxial séparément pour éviter l'usure liée à un excès de mouvement.

## Español

Para prevenir daños al puerto de conexión del cable coaxial, coloque el soporte para el cable coaxial suministrado con el TV en la parte posterior del mismo. Inserte el cable coaxial conectado en el soporte para cables coaxiales y fíjelo en su lugar. Asegúrese de fijar el cable coaxial de forma separada a fin de evitar dañarlo por causa del movimiento excesivo.

## Português

Para evitar danos à porta de conexão do cabo coaxial, prenda o suporte do cabo coaxial fornecido com a TV na parte de trás da TV. Insira o cabo coaxial já conectado no seu suporte e prenda no lugar. Certifique-se de prender o cabo coaxial separadamente, a fim de evitar danos nele, que podem ocorrer em decorrência de movimento excessivo.



# SMART TV

---

Smart Home Entertainment





Please direct all service-related questions or comments to [www.lgusa.com/support](http://www.lgusa.com/support) or call 1.800.243.0000

CMF01  
LG Electronics



First-Class postage required. Post Office will not deliver without proper postage.



PO BOX 174355  
DENVER CO, 80217-4355



← FOLD →  
**PROTECT YOUR INVESTMENT  
DON'T FORGET TO REGISTER!**

**online at [www.lgusa.com/register](http://www.lgusa.com/register) OR** Fill out and return this card

Registering is important, quick and easy!

---

Thank you for purchasing an LG product! We hope you are enjoying your new product and look forward to sharing some insider tips and tricks with you soon. Registering your LG product is simple and also serves as a verification of ownership if your product is stolen or lost.

In addition, you'll receive the following benefits and many more:

- Helpful emails on how to make the most of your product
- Reminders about product downloads and firmware
- More efficient warranty service
- Exclusive information on new products and innovations
- Special offers and promotions

Welcome to the LG family!

Please seal with tape. Do not staple.



# PROTECT YOUR INVESTMENT DON'T FORGET TO REGISTER!

online at [www.lgusa.com/register](http://www.lgusa.com/register) **OR** Fill out and return this card  
within the next 10 days

---

1.  Mr.  Mrs.  Ms.  Miss

First name

Initial

Last name

Street

Apt

City

State / Province

ZIP / Postal Code

Email address

2. Telephone number

(      )      -

4. Model number

3. Date of purchase

    /    /

Month

Day

Year

5. Serial number

6. Name of store where purchased



LG Electronics, Inc.  
LCD Television Limited Warranty - USA

Your LG LCD Television will be repaired or replaced, at LG's option, if it proves to be defective in material or workmanship under normal use, during the warranty period ("Warranty Period") listed below, effective from the date ("Date of Purchase") of original consumer purchase of the product. This warranty is good only to the original purchaser of the product and effective only when used in the United States, excluding U.S. Territories.

WARRANTY PERIOD	HOW SERVICE IS HANDLED
<p><b>LABOR: One Year</b> from the Date of Purchase.</p> <p><b>PARTS: One Year</b> from the Date of Purchase.</p> <p>Replacement Units and Repair Parts may be new or factory remanufactured.</p> <p>Replacement Units and Repair Parts are warranted for the remaining portion of the original unit's warranty period.</p>	<p><b>Please retain</b> dealer's dated bill of sale or delivery ticket as evidence of the Date of Purchase for proof of warranty, and submit a copy of the bill of sale to the service person at the time warranty service is provided.</p> <p><b>CONSUMER USER</b>  <b>Please Call 1-800-243-0000</b> (24 hours a day, 365 days per year) for instructions on getting the defective unit repaired or replaced.            Visit our website at:  <a href="http://www.lgservice.com">http://www.lgservice.com</a></p> <p><b>COMMERCIAL USER</b>  <b>Please Call (888) 865-3026</b> (Staffed during these times Mon. - Fri. 8:00AM ~ 5:00PM Central Standard Time) for instructions on getting the defective unit repaired or replaced.            Visit our website at:  <a href="http://www.lgcommercial.com">http://www.lgcommercial.com</a></p>

**THIS WARRANTY IS IN LIEU OF ANY OTHER WARRANTY, EXPRESS OR IMPLIED, INCLUDING WITHOUT LIMITATION, ANY WARRANTY OF MERCHANTABILITY OR FITNESS FOR A PARTICULAR PURPOSE. TO THE EXTENT ANY IMPLIED WARRANTY IS REQUIRED BY LAW, IT IS LIMITED IN DURATION TO THE EXPRESS WARRANTY PERIOD ABOVE. NEITHER THE MANUFACTURER NOR ITS U.S. DISTRIBUTOR SHALL BE LIABLE FOR ANY INCIDENTAL, CONSEQUENTIAL, INDIRECT, SPECIAL, OR PUNITIVE DAMAGES OF ANY NATURE, INCLUDING WITHOUT LIMITATION, LOST PROFITS, LOST OR CORRUPTED PROGRAMMING OR DATA, OR ANY OTHER DAMAGE WHETHER BASED IN CONTRACT, TORT, OR OTHERWISE.** Some states do not allow the exclusion or limitation of incidental or consequential damages or limitations on how long an implied warranty lasts, so the above exclusion or limitation may not apply to you. This warranty gives you specific legal rights and you may also have other rights that vary from state to state.

**THIS LIMITED WARRANTY DOES NOT APPLY TO:**

<ul style="list-style-type: none"> <li>● damage caused in shipping or transit</li> <li>● service required as a result of improper installation, including incorrect or insufficient AC supply (please consult the owner's manual for power supply requirements).</li> <li>● installation or repair of antenna systems, cable converters, cable company supplied equipment, or other components in a video system</li> <li>● set-up or adjustment on consumer controls, or damage caused by improper adjustments</li> <li>● damage caused by other system components</li> <li>● any unit that has been modified or incorporated into any other product</li> <li>● replacement of batteries on the remote control.</li> </ul>	<ul style="list-style-type: none"> <li>● damage (including cosmetic damage); failure, loss or personal injury due to misuse, abuse, negligence, improper maintenance or storage, or to acts of nature or other causes beyond our control. (Causes beyond our control include but are not limited to lightning strike, power surges, power outages and water damage.)</li> <li>● image burn-in</li> <li>● repair or replacement of warranted parts by other than an LGE authorized service centers.</li> <li>● units purchased or serviced outside of the U.S.A.</li> <li>● product where the original factory serial numbers have been removed, defaced or changed in any way.</li> <li>● product sold and labeled as "as is, where is" or similar disclaimer.</li> </ul>
---	---

The cost of repair or replacement under these excluded circumstances shall be borne by the consumer.

**CUSTOMER INTERACTIVE CENTER NUMBERS**

<p><b>To obtain Customer Assistance, Product Information, or Dealer or Authorized Service Center location:</b></p>	<p><b><u>CONSUMER USER</u></b> <b>Please call 1-800-243-0000</b> (24 hours a day, 365 days per year) and select the appropriate option from the menu. <b>Or visit our website at: <a href="http://www.lgservice.com">http://www.lgservice.com</a></b></p> <p><b><u>COMMERCIAL USER</u></b> <b>Please call (888) 865-3026</b> (Staffed during these times Mon. - Fri. 8:00AM ~ 5:00PM Central standard time) and select the appropriate option from the menu. <b>Or visit our website at: <a href="http://www.lgcommercial.com">http://www.lgcommercial.com</a></b></p>
--	--

**CONCERNING PIXEL FUNCTIONALITY:** An LCD Television contains hundreds of thousands of individual pixels. LCD displays typically contain a small number of pixels that do not function normally. Your display has been inspected and is in compliance with manufacturer's specifications, indicating that any pixel defects do not effect the operation or use of your display.

**BEFORE CALLING FOR SERVICE:**

Please have your product model number, serial number, and the date of purchase available. Under some circumstances you may be asked to provide a reserve deposit to the LGE Service Center, using a credit card number as surety for advanced shipment. Your credit card will not be charged if you return the defective unit within 10 working days. If a replacement unit is received, please use the carton and packaging from that unit in returning the defective unit to the LGE Service Center. Parts and service in accordance with the LGE warranty is our responsibility and will be provided without charge. Other service requirements will be at the owner's expense. If you have problems in obtaining satisfactory warranty service, write or call the LGE Customer Interactive Service. To assure proper credit and avoid unnecessary charges, you must obtain a Return Authorization before returning any product to the Factory Service Center. Contact the Customer Interactive Center for details.

Service for your LGE Television is provided through LG Electronics Alabama, Inc., the authorized LGE Service Center for the United States.

**TO CONTACT LG ELECTRONICS BY MAIL:**  
LGE Customer Interactive Center  
P. O. Box 240007  
201 James Record Road  
Huntsville, Alabama 35824  
ATTN: CIC

LGE LCD Televisions are marketed and distributed in the United States by:  
LG Electronics U.S.A., Inc., 1000 Sylvan Avenue, Englewood Cliffs, NJ 07632