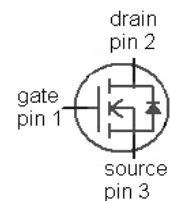
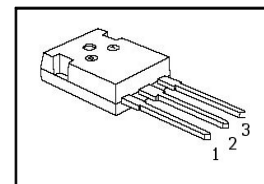

CoolMOS™ Power Transistor
Features

- New revolutionary high voltage technology
- Intrinsic fast-recovery body diode
- Extremely low reverse recovery charge
- Ultra low gate charge
- Extreme dv/dt rated
- High peak current capability
- Periodic avalanche rated
- Qualified for industrial grade applications according to JEDEC¹⁾
- Pb-free lead plating; RoHS compliant

Product Summary

V_{DS}	600	V
$R_{DS(on),max}$	0.083	Ω
I_D	46	A

PG-TO247

Type	Package	Ordering Code	Marking
SPW47N60CFD	PG-TO247	Q67045A5051	47N60CFD

Maximum ratings, at $T_j=25\text{ °C}$, unless otherwise specified

Parameter	Symbol	Conditions	Value	Unit
Continuous drain current	I_D	$T_C=25\text{ °C}$	46	A
		$T_C=100\text{ °C}$	29	
Pulsed drain current ¹⁾	$I_{D,pulse}$	$T_C=25\text{ °C}$	115	
Avalanche energy, single pulse	E_{AS}	$I_D=10\text{ A}, V_{DD}=50\text{ V}$	1800	mJ
Avalanche energy, repetitive t_{AR} ^{2),3)}	E_{AR}	$I_D=20\text{ A}, V_{DD}=50\text{ V}$	1	
Avalanche current, repetitive t_{AR} ^{2),3)}	I_{AR}		20	A
Drain source voltage slope	dv/dt	$I_D=46\text{ A}, V_{DS}=480\text{ V}, T_j=125\text{ °C}$	80	V/ns
Reverse diode dv/dt	dv/dt	$I_S=46\text{ A}, V_{DS}=480\text{ V}, T_j=125\text{ °C}$	40	V/ns
Maximum diode commutation speed	di/dt		600	A/ μ s
Gate source voltage	V_{GS}	static	± 20	V
		AC ($f>1\text{ Hz}$)	± 30	
Power dissipation	P_{tot}	$T_C=25\text{ °C}$	417	W
Operating and storage temperature	T_j, T_{stg}		-55 ... 150	$^{\circ}\text{C}$

Parameter	Symbol	Conditions	Values			Unit
			min.	typ.	max.	

Thermal characteristics

Thermal resistance, junction - case	R_{thJC}		-	-	0.3	K/W
Thermal resistance, junction - ambient	R_{thJA}	leaded	-	-	62	
Soldering temperature, wave soldering	T_{sold}	1.6 mm (0.063 in.) from case for 10 s	-	-	260	°C

Electrical characteristics, at $T_j=25\text{ °C}$, unless otherwise specified
Static characteristics

Drain-source breakdown voltage	$V_{(BR)DSS}$	$V_{GS}=0\text{ V}, I_D=250\text{ }\mu\text{A}$	600	-	-	V
Avalanche breakdown voltage	$V_{(BR)DS}$	$V_{GS}=0\text{ V}, I_D=46\text{ A}$	-	700	-	
Gate threshold voltage	$V_{GS(th)}$	$V_{DS}=V_{GS}, I_D=2.9\text{ mA}$	3	4	5	
Zero gate voltage drain current	I_{DSS}	$V_{DS}=600\text{ V}, V_{GS}=0\text{ V}, T_j=25\text{ °C}$	-	6	-	μA
		$V_{DS}=600\text{ V}, V_{GS}=0\text{ V}, T_j=150\text{ °C}$	-	5000	-	
Gate-source leakage current	I_{GSS}	$V_{GS}=20\text{ V}, V_{DS}=0\text{ V}$	-	-	100	nA
Drain-source on-state resistance	$R_{DS(on)}$	$V_{GS}=10\text{ V}, I_D=29\text{ A}, T_j=25\text{ °C}$	-	0.07	0.083	Ω
		$V_{GS}=10\text{ V}, I_D=29\text{ A}, T_j=150\text{ °C}$	-	0.15	-	
Gate resistance	R_G	$f=1\text{ MHz}$, open drain	-	0.62	-	
Transconductance	g_{fs}	$ V_{DS} >2 I_D R_{DS(on)max}, I_D=29\text{ A}$	-	30	-	S

Parameter	Symbol	Conditions	Values			Unit
			min.	typ.	max.	

Dynamic characteristics

Input capacitance	C_{iss}	$V_{GS}=0\text{ V}, V_{DS}=25\text{ V},$ $f=1\text{ MHz}$	-	7700	-	pF
Output capacitance	C_{oss}		-	2200	-	
Reverse transfer capacitance	C_{rss}		-	77	-	
Effective output capacitance, energy related ⁴⁾	$C_{o(er)}$	$V_{GS}=0\text{ V}, V_{DS}=0\text{ V}$ to 480 V	-	245	-	
Effective output capacitance, time related ⁵⁾	$C_{o(tr)}$		-	453	-	
Turn-on delay time	$t_{d(on)}$	$V_{DD}=400\text{ V},$ $V_{GS}=10\text{ V}, I_D=46\text{ A},$ $R_G=3.3\ \Omega$	-	30	-	ns
Rise time	t_r		-	30	-	
Turn-off delay time	$t_{d(off)}$		-	100	-	
Fall time	t_f		-	15	-	

Gate Charge Characteristics

Gate to source charge	Q_{gs}	$V_{DD}=480\text{ V}, I_D=46\text{ A},$ $V_{GS}=0\text{ to }10\text{ V}$	-	54	-	nC
Gate to drain charge	Q_{gd}		-	130	-	
Gate charge total	Q_g		-	248	322	
Gate plateau voltage	$V_{plateau}$		-	7.1	-	V

¹⁾ J-STD20 and JESD22

²⁾ Pulse width t_p limited by $T_{j,max}$

³⁾ Repetitive avalanche causes additional power losses that can be calculated as $P_{AV}=E_{AR} \cdot f$.

⁴⁾ $C_{o(er)}$ is a fixed capacitance that gives the same stored energy as C_{oss} while V_{DS} is rising from 0 to 80% V_{DSS} .

⁵⁾ $C_{o(tr)}$ is a fixed capacitance that gives the same charging time as C_{oss} while V_{DS} is rising from 0 to 80% V_{DSS} .

Parameter	Symbol	Conditions	Values			Unit
			min.	typ.	max.	
Reverse Diode						
Diode continuous forward current	I_S	$T_C=25\text{ }^\circ\text{C}$	-	-	46	A
Diode pulse current	$I_{S,pulse}$		-	-	115	
Diode forward voltage	V_{SD}	$V_{GS}=0\text{ V}, I_F=46\text{ A}, T_j=25\text{ }^\circ\text{C}$	-	1.0	1.2	V
Reverse recovery time	t_{rr}	$V_R=480\text{ V}, I_F=I_S, di_F/dt=100\text{ A}/\mu\text{s}$	-	210	-	ns
Reverse recovery charge	Q_{rr}		-	2	-	μC
Peak reverse recovery current	I_{rrm}		-	18	-	A

Typical Transient Thermal Characteristics

Symbol	Value	Unit	Symbol	Value	Unit
	typ.			typ.	
R_{th1}	0.00289	K/W	C_{th1}	0.000564	Ws/K
R_{th2}	0.00399		C_{th2}	0.0034	
R_{th3}	0.0224		C_{th3}	0.0048	
R_{th4}	0.0421		C_{th4}	0.0273	
R_{th5}	0.0619		C_{th5}	0.149	
			C_{th6}	$4.4^{5)}$	

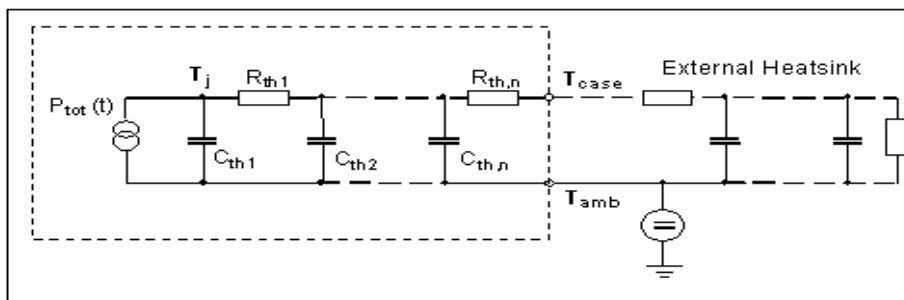

⁵⁾ C_{th6} models the additional heat capacitance of the package in case of non-ideal cooling. It is not needed if $R_{thCA}=0\text{ K/W}$.

1 Power dissipation

$P_{tot}=f(T_c)$

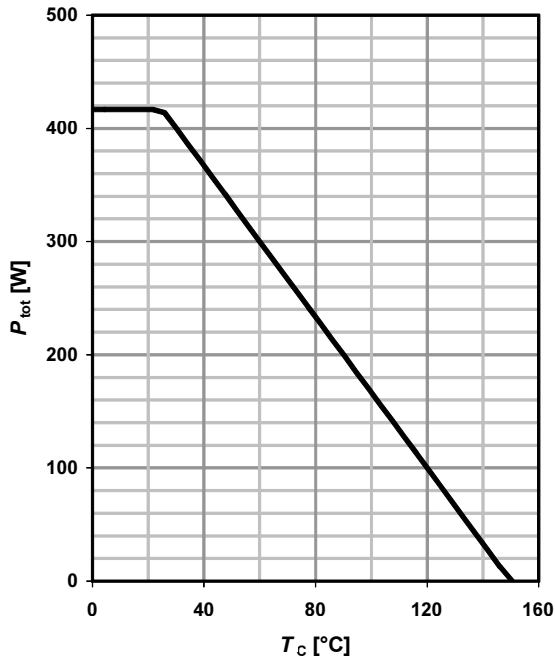

2 Safe operating area

$I_D=f(V_{DS}); T_c=25\text{ °C}; D=0$

parameter: t_p

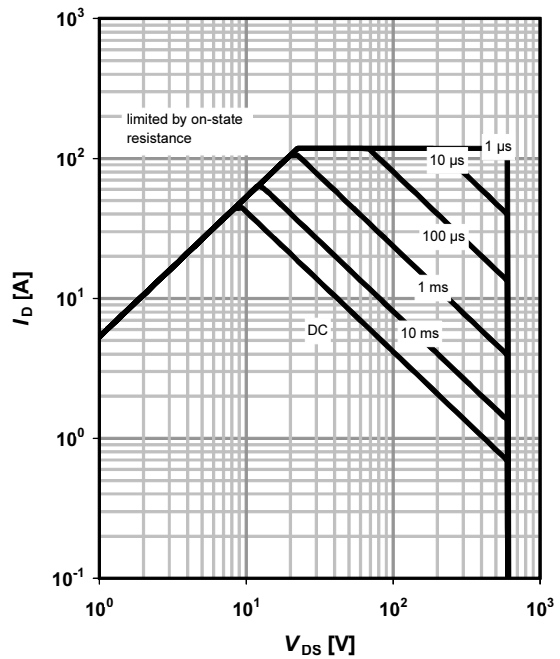

3 Max. transient thermal impedance

$I_D=f(V_{DS}); T_j=25\text{ °C}$

parameter: $D=t_p/T$

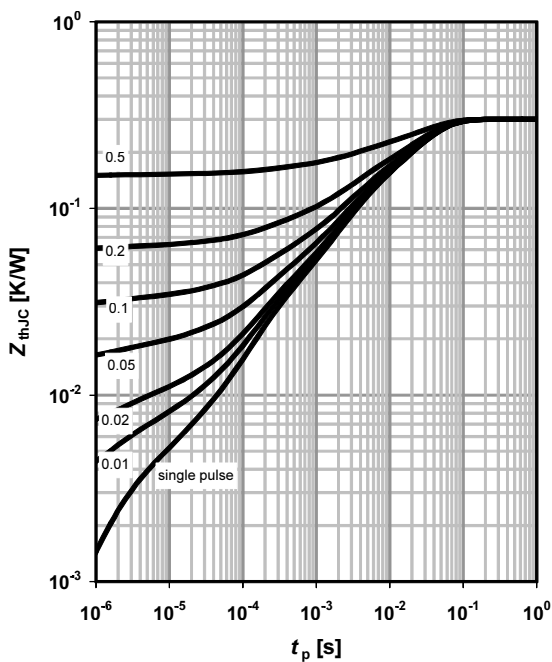

4 Typ. output characteristics

$I_D=f(V_{DS}); T_j=25\text{ °C}$

parameter: V_{GS}

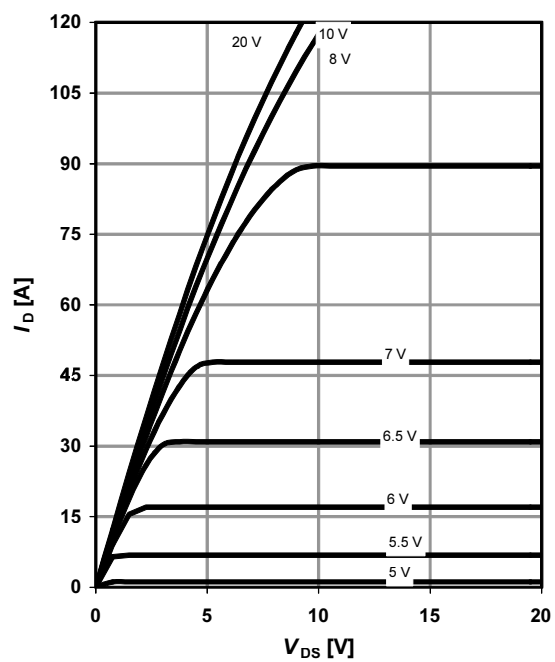

5 Typ. output characteristics

$I_D = f(V_{DS}); T_j = 150\text{ °C}$

parameter: V_{GS}

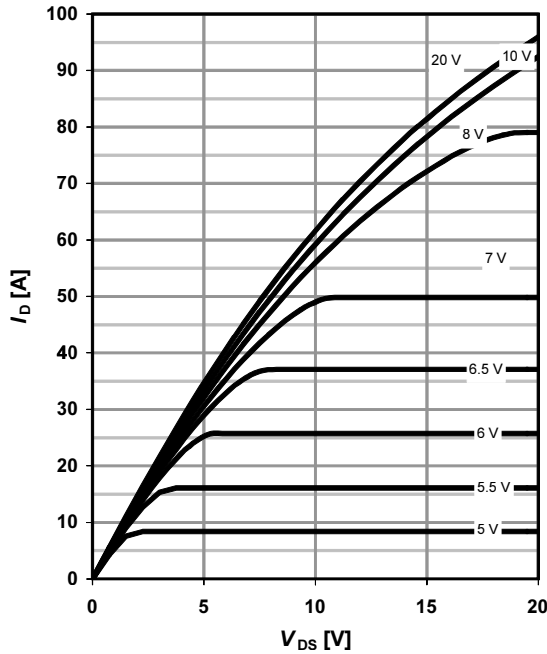

6 Typ. drain-source on-state resistance

$R_{DS(on)} = f(I_D); T_j = 150\text{ °C}$

parameter: V_{GS}

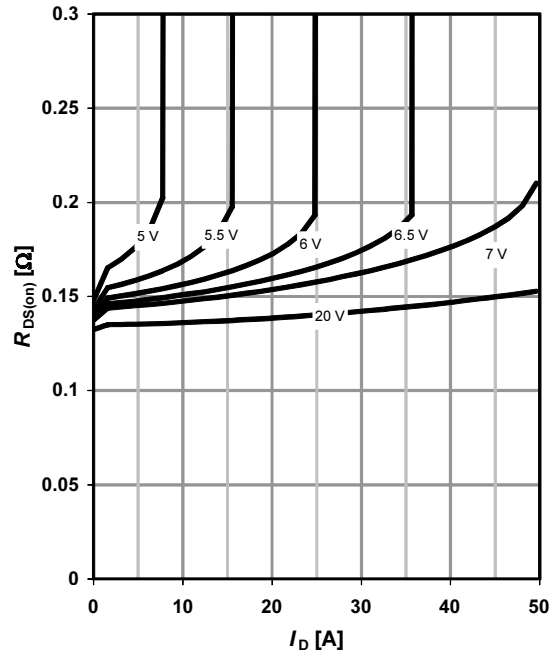

7 Drain-source on-state resistance

$R_{DS(on)} = f(T_j); I_D = 30\text{ A}; V_{GS} = 10\text{ V}$

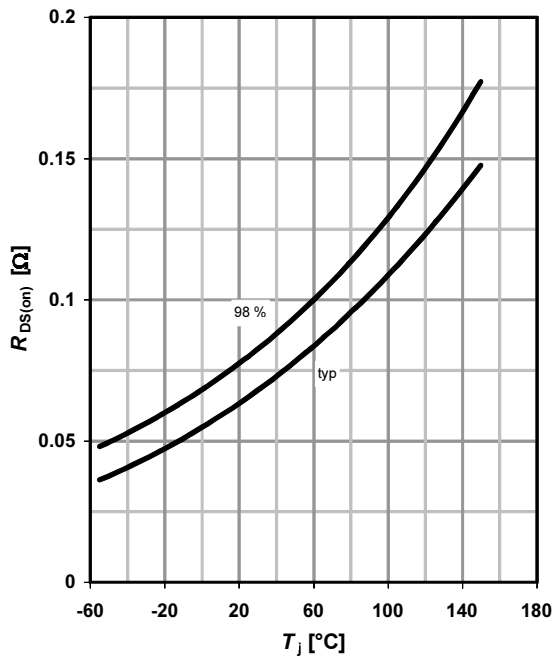

8 Typ. transfer characteristics

$I_D = f(V_{GS}); |V_{DS}| > 2|I_D|R_{DS(on)max}$

parameter: T_j

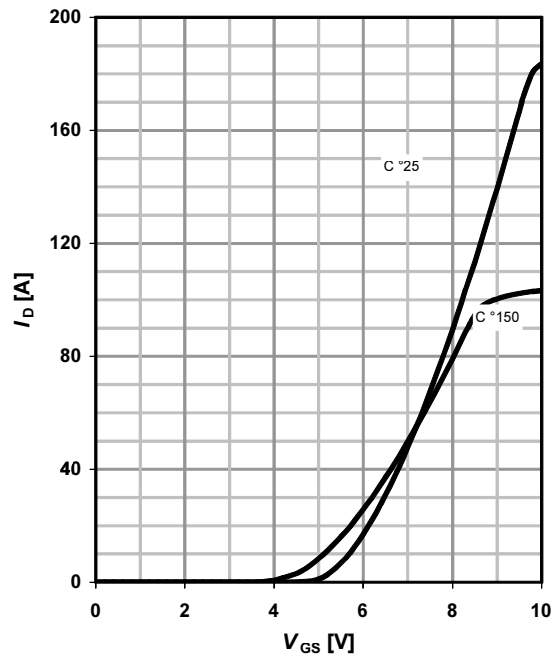

9 Typ. gate charge

$V_{GS}=f(Q_{gate}); I_D=47\text{ A pulsed}$

parameter: V_{DD}

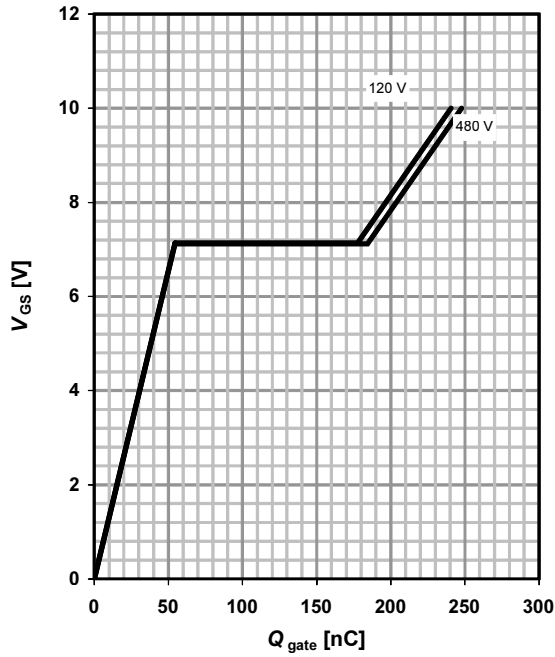

10 Forward characteristics of reverse diode

$I_F=f(V_{SD})$

parameter: T_j

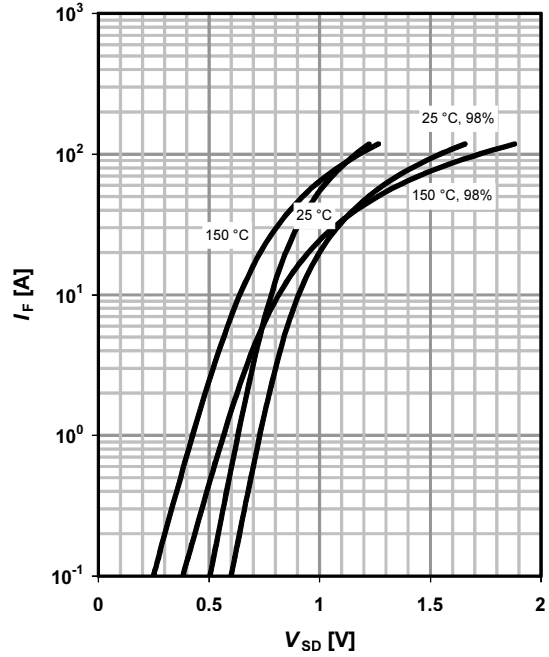

11 Avalanche SOA

$I_{AR}=f(t_{AR})$

parameter: $T_{j(start)}$

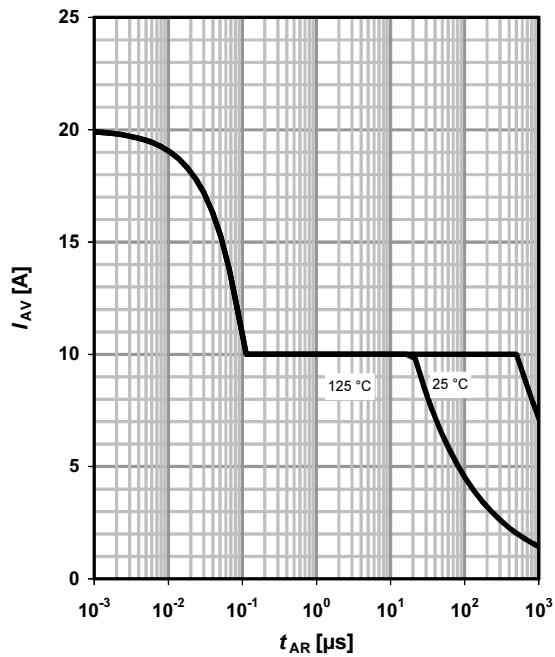

12 Avalanche energy

$E_{AS}=f(T_j); I_D=10\text{ A}; V_{DD}=50\text{ V}$

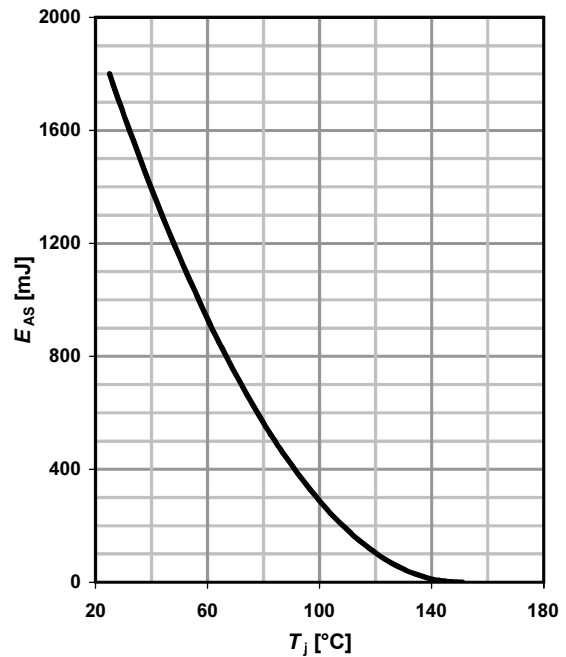

13 Drain-source breakdown voltage

$V_{BR(DSS)} = f(T_j); I_D = 15 \text{ mA}$

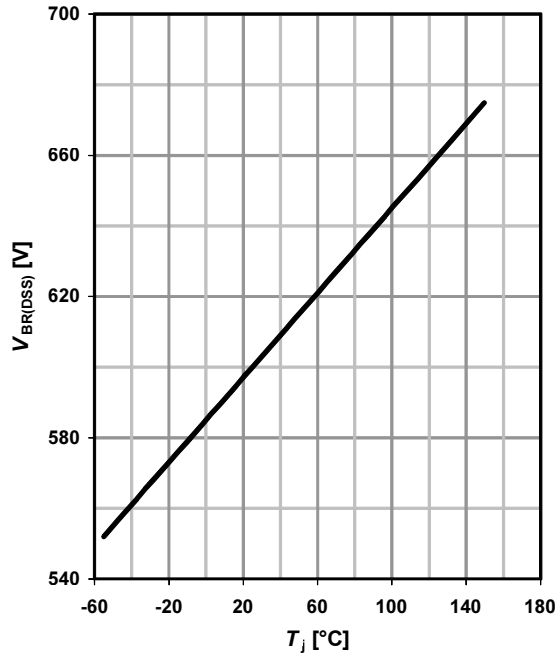

14 Typ. capacitances

$C = f(V_{DS}); V_{GS} = 0 \text{ V}; f = 1 \text{ MHz}$

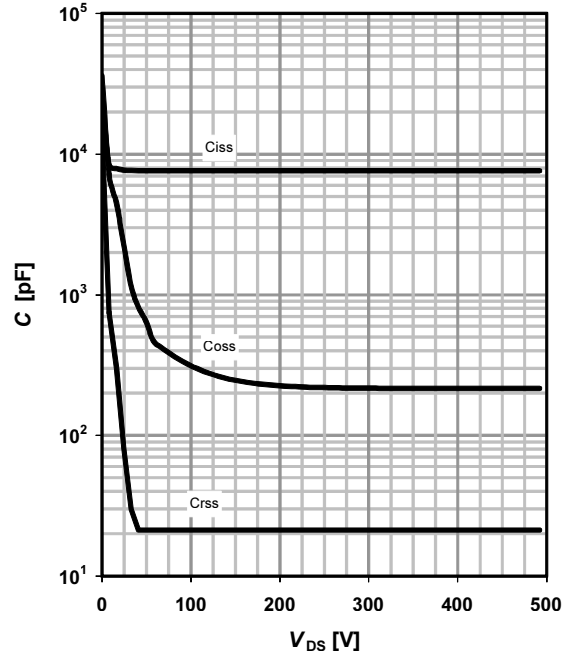

15 Typ. C_{oss} stored energy

$E_{oss} = f(V_{DS})$

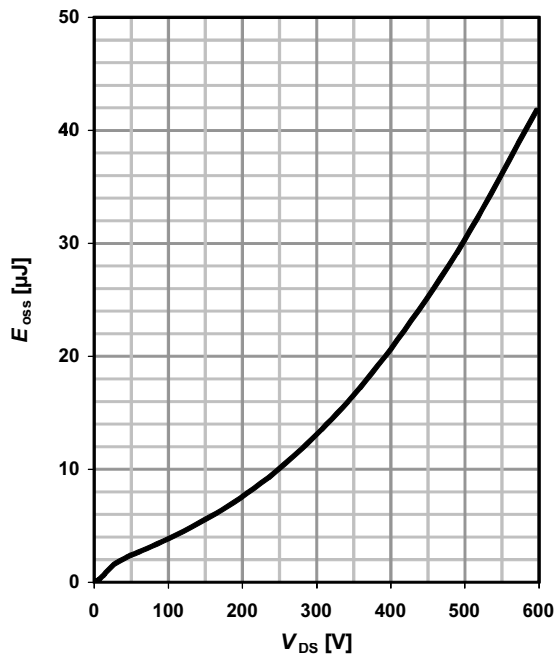

16 Typ. reverse recovery charge

$Q_{rr} = f(T_j); I_S = 47 \text{ A}; di/dt = 100 \text{ A/μs}$

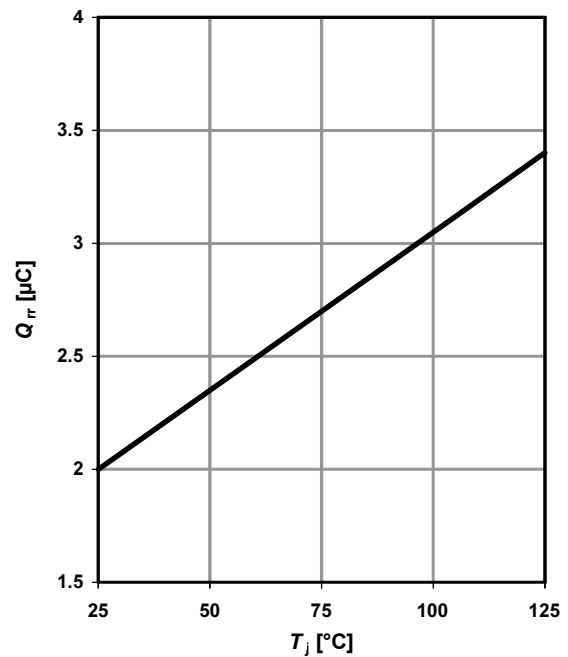

17 Typ. reverse recovery charge

$Q_{rr}=f(I_S); di/dt=100 \text{ A}/\mu\text{s}$

parameter: T_j

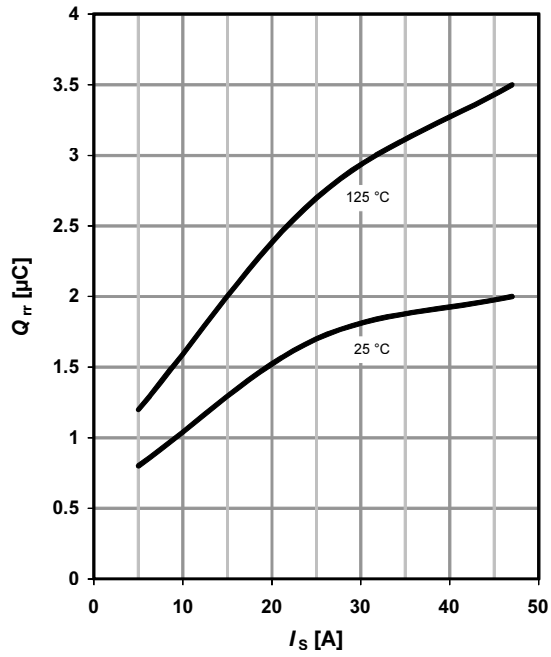

18 Typ. reverse recovery charge

$Q_{rr}=f(di/dt); I_S=47 \text{ A}$

parameter: T_j

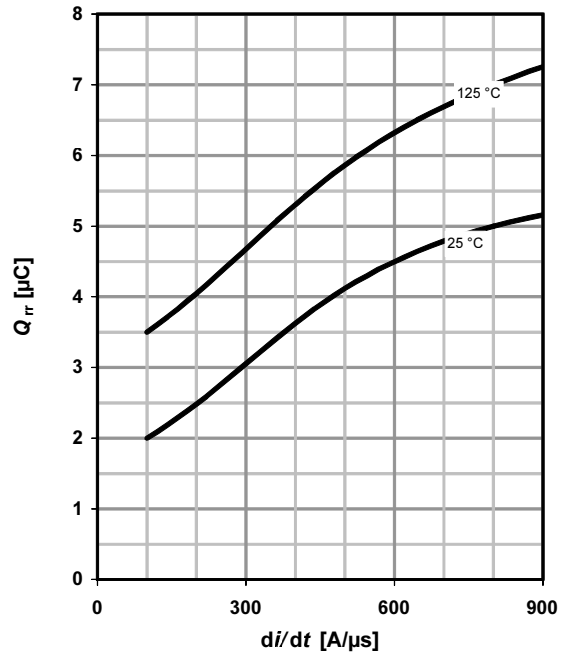

Definition of diode switching characteristics

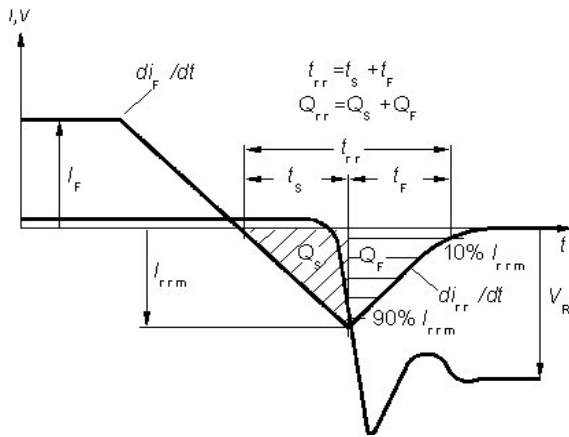

PG-TO247-3-21-41

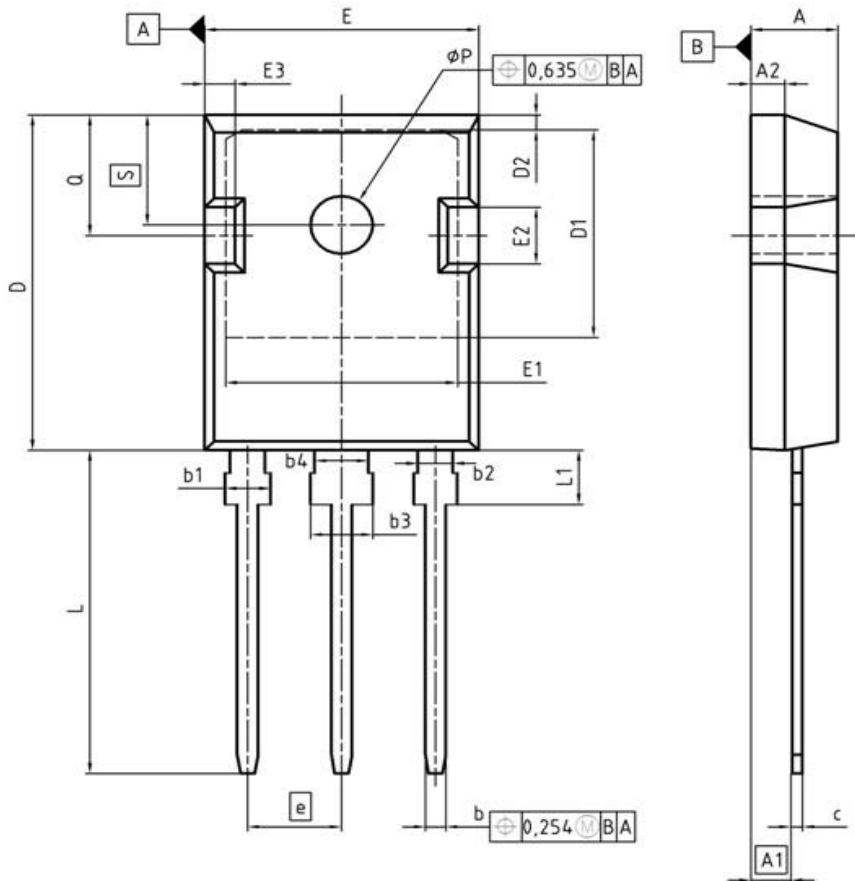

DIM	MILLIMETERS		INCHES	
	MIN	MAX	MIN	MAX
A	4.90	5.16	0.193	0.203
A1	2.27	2.53	0.089	0.099
A2	1.85	2.11	0.073	0.083
b	1.07	1.33	0.042	0.052
b1	1.90	2.41	0.075	0.095
b2	1.90	2.16	0.075	0.085
b3	2.87	3.38	0.113	0.133
b4	2.87	3.13	0.113	0.123
c	0.55	0.68	0.022	0.027
D	20.82	21.10	0.820	0.831
D1	16.25	17.65	0.640	0.695
D2	1.05	1.35	0.041	0.053
E	15.70	16.03	0.618	0.631
E1	13.10	14.15	0.516	0.557
E2	3.68	5.10	0.145	0.201
E3	1.68	2.60	0.066	0.102
e	5.44		0.214	
N	3		3	
L	19.80	20.31	0.780	0.799
L1	4.17	4.47	0.164	0.176
ϕP	3.50	3.70	0.138	0.146
Q	5.49	6.00	0.216	0.236
S	6.04	6.30	0.238	0.248

DOCUMENT NO.
Z8B00003327

SCALE

EUROPEAN PROJECTION

ISSUE DATE
17-12-2007

REVISION
03

Published by**Infineon Technologies AG****81726 Munich, Germany****© 2008 Infineon Technologies AG****All Rights Reserved.****Legal Disclaimer**

The information given in this document shall in no event be regarded as a guarantee of conditions or characteristics. With respect to any examples or hints given herein, any typical values stated herein and/or any information regarding the application of the device, Infineon Technologies hereby disclaims any and all warranties and liabilities of any kind, including without limitation, warranties of non-infringement of intellectual property rights of any third party.

Information

For further information on technology, delivery terms and conditions and prices, please contact the nearest Infineon Technologies Office (www.infineon.com).

Warnings

Due to technical requirements, components may contain dangerous substances. For information on the types in question, please contact the nearest Infineon Technologies Office. The Infineon Technologies component described in this Data Sheet may be used in life-support devices or systems and/or automotive, aviation and aerospace applications or systems only with the express written approval of Infineon Technologies, if a failure of such components can reasonably be expected to cause the failure of that life-support, automotive, aviation and aerospace device or system or to affect the safety or effectiveness of that device or system. Life support devices or systems are intended to be implanted in the human body or to support and/or maintain and sustain and/or protect human life. If they fail, it is reasonable to assume that the health of the user or other persons may be endangered.

1 New package outlines TO-247

Assembly capacity extension for CoolMOSTM technology products assembled in lead-free package PG-TO247-3 at subcontractor ASE (Weihai) Inc., China (Changes are marked in blue.)



Figure 1 Outlines TO-247, dimensions in mm/inches