

TOSHIBA Bipolar Linear Integrated Circuit Silicon Monolithic

TA48M025F, TA48M03F, TA48M033F TA48M0345F, TA48M04F, TA48M05F

2.5 V, 3 V, 3.3 V, 3.45 V, 4 V, 5 V

Three-Terminal Low Dropout Voltage Regulator

The TA48M**F series consists of fixed-positive-output, low dropout regulators with an output current of 500 mA (max). In response to the need for low voltage devices, the series offers devices with low output voltages of 2.5 V, 3.3 V etc.

Features

- Maximum output current of 0.5 A
- Low standby current: 800 μ A (typ.)
- Low dropout voltage: 0.65 V (max) @ $I_{OUT} = 0.5$ A
- Protection function:
overcurrent/overheat/overvoltage/reversed power supply connections.
- New PW-Mold package (Surface-mount type)

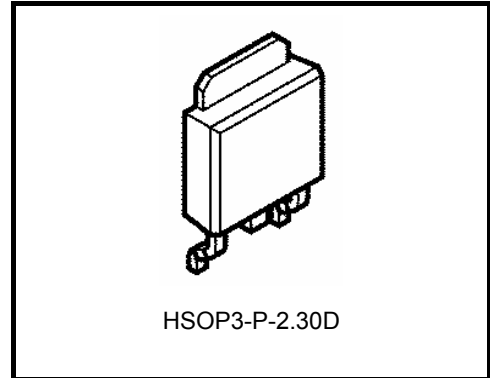

Weight
HSOP3-P-2.30D: 0.36 g (typ.)

Pin Assignment

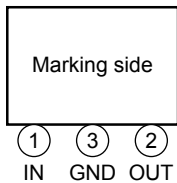

Marking

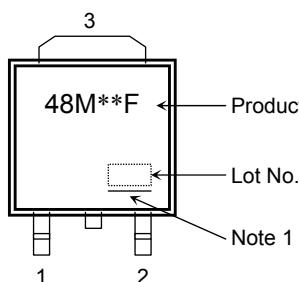

Note 1: A line under a Lot No. identifies the indication of product Labels.

Not underlined: $[[Pb]]/INCLUDES > MCV$

Underlined: $[[G]]/RoHS COMPATIBLE$ or $[[G]]/RoHS [[Pb]]$

Please contact your TOSHIBA sales representative for details as to environmental matters such as the RoHS compatibility of Product. The RoHS is the Directive 2002/95/EC of the European Parliament and of the Council of 27 January 2003 on the restriction of the use of certain hazardous substances in electrical and electronic equipment.

Note 2: The “**” part of each product number varies according to the output voltage of the product.

The product(s) in this document (“Product”) contain functions intended to protect the Product from temporary small overloads such as minor short-term overcurrent, overvoltage, or overheating. The protective functions do not necessarily protect Product under all circumstances. When incorporating Product into your system, please design the system (1) to avoid such overloads upon the Product, and (2) to shut down or otherwise relieve the Product of such overload conditions immediately upon occurrence. For details, please refer to the notes appearing below in this document and other documents referenced in this document.

Ordering Method

Product Name	Package (Lead Type)	Packing Form
TA48M**F (T6L1, SNQ)	New PW-Mold: Surface-mount	Tape (2000 pcs ./ reel)

Note: The “**” in each pro-forma product name is replaced with the output voltage of each product.

Block Diagram

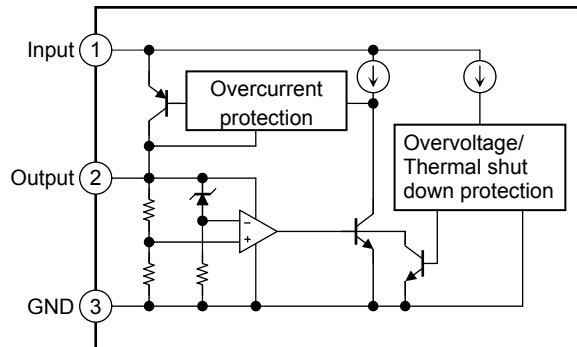

Absolute Maximum Ratings (Ta = 25°C)

Characteristics	Symbol	Rating	Unit
Input voltage	V_{IN}	29	V
Output current	I_{OUT}	0.5	A
Power dissipation	P_D	(Ta = 25°C)	1
		(Tc = 25°C)	10
Operating junction temperature	T_{jopr}	-40 to 150	°C
Storage temperature	T_{stg}	-55 to 150	°C
Junction temperature	T_j	150	°C
Thermal resistance	$R_{th(j-c)}$	12.5	°C/W
	$R_{th(j-a)}$	125	

Note: Using continuously under heavy loads (e.g. the application of high temperature/current/voltage and the significant change in temperature, etc.) may cause this product to decrease in the reliability significantly even if the operating conditions (i.e. operating temperature/current/voltage, etc.) are within the absolute maximum ratings and the operating ranges.

Please design the appropriate reliability upon reviewing the Toshiba Semiconductor Reliability Handbook (“Handling Precautions”/“Derating Concept and Methods”) and individual reliability data (i.e. reliability test report and estimated failure rate, etc).

Protection Function (reference)

Characteristics	Symbol	Min	Typ.	Max	Unit
Overvoltage	V_{IN}	29	33	—	V
Overheat	T_j	—	175	—	°C

TA48M025F

Electrical Characteristics

(unless otherwise specified, $V_{IN} = 4.5\text{ V}$, $I_{OUT} = 250\text{ mA}$, $T_j = 25^\circ\text{C}$, $C_{IN} = 0.1\ \mu\text{F}$, $C_{OUT} = 10\ \mu\text{F}$)

Characteristics	Symbol	Test Circuit	Test Condition	Min	Typ.	Max	Unit
Output voltage	V_{OUT}	—	—	2.4	2.5	2.6	V
		—	$3.5\text{ V} \leq V_{IN} \leq 16\text{ V}$, $5\text{ mA} \leq I_{OUT} \leq 500\text{ mA}$, $0^\circ\text{C} \leq T_j \leq 125^\circ\text{C}$	2.375	2.5	2.625	
Line regulation	Reg.line	—	$3.5\text{ V} \leq V_{IN} \leq 16\text{ V}$	—	7	18	mV
Load regulation	Reg.load	—	$5\text{ mA} \leq I_{OUT} \leq 500\text{ mA}$	—	45	90	mV
Quiescent current	I_B	—	$3.5\text{ V} \leq V_{IN} \leq 16\text{ V}$, $I_{OUT} = 0\text{ mA}$	—	0.8	1.4	mA
		—	$3.5\text{ V} \leq V_{IN} \leq 16\text{ V}$, $I_{OUT} = 250\text{ mA}$	—	12	25	
Output noise voltage	V_{NO}	—	$10\text{ Hz} \leq f \leq 100\text{ kHz}$, $I_{OUT} = 50\text{ mA}$	—	72	—	μVrms
Ripple rejection	R.R.	—	$f = 120\text{ Hz}$, $3.5\text{ V} \leq V_{IN} \leq 16\text{ V}$, $I_{OUT} = 50\text{ mA}$	62	72	—	dB
Dropout voltage	V_D	—	$I_{OUT} = 250\text{ mA}$	—	0.17	0.35	V
		—	$I_{OUT} = 500\text{ mA}$	—	0.35	0.65	
Peak circuit current	I_{PEAK}	—	—	0.60	1.15	1.40	A
Short circuit current	I_{SC}	—	—	0.60	1.15	1.40	A

TA48M03F

Electrical Characteristics

(unless otherwise specified, $V_{IN} = 5\text{ V}$, $I_{OUT} = 250\text{ mA}$, $T_j = 25^\circ\text{C}$, $C_{IN} = 0.1\ \mu\text{F}$, $C_{OUT} = 10\ \mu\text{F}$)

Characteristics	Symbol	Test Circuit	Test Condition	Min	Typ.	Max	Unit
Output voltage	V_{OUT}	—	—	2.88	3.0	3.12	V
		—	$4\text{ V} \leq V_{IN} \leq 16\text{ V}$, $5\text{ mA} \leq I_{OUT} \leq 500\text{ mA}$, $0^\circ\text{C} \leq T_j \leq 125^\circ\text{C}$	2.85	3.0	3.15	
Line regulation	Reg.line	—	$4\text{ V} \leq V_{IN} \leq 16\text{ V}$	—	8	21	mV
Load regulation	Reg.load	—	$5\text{ mA} \leq I_{OUT} \leq 500\text{ mA}$	—	45	95	mV
Quiescent current	I_B	—	$4\text{ V} \leq V_{IN} \leq 16\text{ V}$, $I_{OUT} = 0\text{ mA}$	—	0.8	1.4	mA
		—	$4\text{ V} \leq V_{IN} \leq 16\text{ V}$, $I_{OUT} = 250\text{ mA}$	—	12	25	
Output noise voltage	V_{NO}	—	$10\text{ Hz} \leq f \leq 100\text{ kHz}$, $I_{OUT} = 50\text{ mA}$	—	90	—	μVrms
Ripple rejection	R.R.	—	$f = 120\text{ Hz}$, $4\text{ V} \leq V_{IN} \leq 16\text{ V}$, $I_{OUT} = 50\text{ mA}$	60	70	—	dB
Dropout voltage	V_D	—	$I_{OUT} = 250\text{ mA}$	—	0.17	0.35	V
		—	$I_{OUT} = 500\text{ mA}$	—	0.35	0.65	
Peak circuit current	I_{PEAK}	—	—	0.60	1.20	1.45	A
Short circuit current	I_{SC}	—	—	0.60	1.20	1.45	A

TA48M033F

Electrical Characteristics

(unless otherwise specified, $V_{IN} = 5.3 \text{ V}$, $I_{OUT} = 250 \text{ mA}$, $T_j = 25^\circ\text{C}$, $C_{IN} = 0.1 \mu\text{F}$, $C_{OUT} = 10 \mu\text{F}$)

Characteristics	Symbol	Test Circuit	Test Condition	Min	Typ.	Max	Unit
Output voltage	V_{OUT}	—	—	3.168	3.3	3.432	V
		—	$4.3 \text{ V} \leq V_{IN} \leq 16 \text{ V}$, $5 \text{ mA} \leq I_{OUT} \leq 500 \text{ mA}$, $0^\circ\text{C} \leq T_j \leq 125^\circ\text{C}$	3.135	3.3	3.465	
Line regulation	Reg-line	—	$4.3 \text{ V} \leq V_{IN} \leq 16 \text{ V}$	—	10	23	mV
Load regulation	Reg-load	—	$5 \text{ mA} \leq I_{OUT} \leq 500 \text{ mA}$	—	45	105	mV
Quiescent current	I_B	—	$4.3 \text{ V} \leq V_{IN} \leq 16 \text{ V}$, $I_{OUT} = 0 \text{ mA}$	—	0.8	1.4	mA
		—	$4.3 \text{ V} \leq V_{IN} \leq 16 \text{ V}$, $I_{OUT} = 250 \text{ mA}$	—	12	25	
Output noise voltage	V_{NO}	—	$10 \text{ Hz} \leq f \leq 100 \text{ kHz}$, $I_{OUT} = 50 \text{ mA}$	—	90	—	μVrms
Ripple rejection	R.R.	—	$f = 120 \text{ Hz}$, $4.3 \text{ V} \leq V_{IN} \leq 16 \text{ V}$, $I_{OUT} = 50 \text{ mA}$	60	70	—	dB
Dropout voltage	V_D	—	$I_{OUT} = 250 \text{ mA}$	—	0.17	0.35	V
		—	$I_{OUT} = 500 \text{ mA}$	—	0.35	0.65	
Peak circuit current	I_{PEAK}	—	—	0.60	1.20	1.45	A
Short circuit current	I_{SC}	—	—	0.60	1.20	1.45	A

TA48M0345F

Electrical Characteristics

(unless otherwise specified, $V_{IN} = 5.45 \text{ V}$, $I_{OUT} = 250 \text{ mA}$, $T_j = 25^\circ\text{C}$, $C_{IN} = 0.1 \mu\text{F}$, $C_{OUT} = 10 \mu\text{F}$)

Characteristics	Symbol	Test Circuit	Test Condition	Min	Typ.	Max	Unit
Output voltage	V_{OUT}	—	—	3.312	3.45	3.588	V
		—	$4.45 \text{ V} \leq V_{IN} \leq 16 \text{ V}$, $5 \text{ mA} \leq I_{OUT} \leq 500 \text{ mA}$, $0^\circ\text{C} \leq T_j \leq 125^\circ\text{C}$	3.278	3.45	3.622	
Line regulation	Reg-line	—	$4.45 \text{ V} \leq V_{IN} \leq 16 \text{ V}$	—	12	25	mV
Load regulation	Reg-load	—	$5 \text{ mA} \leq I_{OUT} \leq 500 \text{ mA}$	—	45	110	mV
Quiescent current	I_B	—	$4.45 \text{ V} \leq V_{IN} \leq 16 \text{ V}$, $I_{OUT} = 0 \text{ mA}$	—	0.8	1.4	mA
		—	$4.45 \text{ V} \leq V_{IN} \leq 16 \text{ V}$, $I_{OUT} = 250 \text{ mA}$	—	12	25	
Output noise voltage	V_{NO}	—	$10 \text{ Hz} \leq f \leq 100 \text{ kHz}$, $I_{OUT} = 50 \text{ mA}$	—	90	—	μVrms
Ripple rejection	R.R.	—	$f = 120 \text{ Hz}$, $4.45 \text{ V} \leq V_{IN} \leq 16 \text{ V}$, $I_{OUT} = 50 \text{ mA}$	60	70	—	dB
Dropout voltage	V_D	—	$I_{OUT} = 250 \text{ mA}$	—	0.17	0.35	V
		—	$I_{OUT} = 500 \text{ mA}$	—	0.35	0.65	
Peak circuit current	I_{PEAK}	—	—	0.60	1.20	1.45	A
Short circuit current	I_{SC}	—	—	0.60	1.20	1.45	A

TA48M04F

Electrical Characteristics

(unless otherwise specified, $V_{IN} = 6\text{ V}$, $I_{OUT} = 250\text{ mA}$, $T_j = 25^\circ\text{C}$, $C_{IN} = 0.1\ \mu\text{F}$, $C_{OUT} = 10\ \mu\text{F}$)

Characteristics	Symbol	Test Circuit	Test Condition	Min	Typ.	Max	Unit
Output voltage	V_{OUT}	—	—	3.84	4.0	4.16	V
		—	$5\text{ V} \leq V_{IN} \leq 16\text{ V}$, $5\text{ mA} \leq I_{OUT} \leq 500\text{ mA}$, $0^\circ\text{C} \leq T_j \leq 125^\circ\text{C}$	3.8	4.0	4.2	
Line regulation	Reg-line	—	$5\text{ V} \leq V_{IN} \leq 16\text{ V}$	—	11	28	mV
Load regulation	Reg-load	—	$5\text{ mA} \leq I_{OUT} \leq 500\text{ mA}$	—	45	115	mV
Quiescent current	I_B	—	$5\text{ V} \leq V_{IN} \leq 16\text{ V}$, $I_{OUT} = 0\text{ mA}$	—	0.9	1.4	mA
		—	$5\text{ V} \leq V_{IN} \leq 16\text{ V}$, $I_{OUT} = 250\text{ mA}$	—	13	25	
Output noise voltage	V_{NO}	—	$10\text{ Hz} \leq f \leq 100\text{ kHz}$, $I_{OUT} = 50\text{ mA}$	—	110	—	μVrms
Ripple rejection	R.R.	—	$f = 120\text{ Hz}$, $5\text{ V} \leq V_{IN} \leq 16\text{ V}$, $I_{OUT} = 50\text{ mA}$	58	68	—	dB
Dropout voltage	V_D	—	$I_{OUT} = 250\text{ mA}$	—	0.17	0.35	V
		—	$I_{OUT} = 500\text{ mA}$	—	0.35	0.65	
Peak circuit current	I_{PEAK}	—	—	0.60	1.25	1.50	A
Short circuit current	I_{SC}	—	—	0.60	1.25	1.50	A

TA48M05F

Electrical Characteristics

(unless otherwise specified, $V_{IN} = 7\text{ V}$, $I_{OUT} = 250\text{ mA}$, $T_j = 25^\circ\text{C}$, $C_{IN} = 0.1\ \mu\text{F}$, $C_{OUT} = 10\ \mu\text{F}$)

Characteristics	Symbol	Test Circuit	Test Condition	Min	Typ.	Max	Unit
Output voltage	V_{OUT}	—	—	4.8	5.0	5.2	V
		—	$6\text{ V} \leq V_{IN} \leq 18\text{ V}$, $5\text{ mA} \leq I_{OUT} \leq 500\text{ mA}$, $0^\circ\text{C} \leq T_j \leq 125^\circ\text{C}$	4.75	5.0	5.25	
Line regulation	Reg-line	—	$6\text{ V} \leq V_{IN} \leq 18\text{ V}$	—	15	35	mV
Load regulation	Reg-load	—	$5\text{ mA} \leq I_{OUT} \leq 500\text{ mA}$	—	50	135	mV
Quiescent current	I_B	—	$6\text{ V} \leq V_{IN} \leq 18\text{ V}$, $I_{OUT} = 0\text{ mA}$	—	1.0	1.4	mA
		—	$6\text{ V} \leq V_{IN} \leq 18\text{ V}$, $I_{OUT} = 250\text{ mA}$	—	13	25	
Output noise voltage	V_{NO}	—	$10\text{ Hz} \leq f \leq 100\text{ kHz}$, $I_{OUT} = 50\text{ mA}$	—	125	—	μVrms
Ripple rejection	R.R.	—	$f = 120\text{ Hz}$, $6\text{ V} \leq V_{IN} \leq 18\text{ V}$, $I_{OUT} = 50\text{ mA}$	58	68	—	dB
Dropout voltage	V_D	—	$I_{OUT} = 250\text{ mA}$	—	0.17	0.35	V
		—	$I_{OUT} = 500\text{ mA}$	—	0.35	0.65	
Peak circuit current	I_{PEAK}	—	—	0.60	1.30	1.55	A
Short circuit current	I_{SC}	—	—	0.60	1.30	1.55	A

Standard Application Circuit

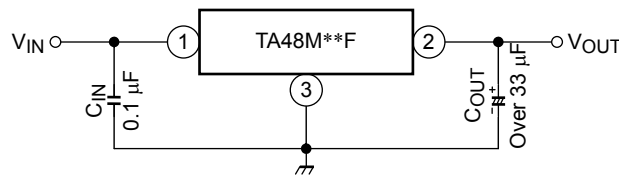

- Place C_{IN} as close as possible to the input terminal and GND. Place C_{OUT} as close as possible to the output terminal and GND. Although capacitor C_{OUT} acts to smooth the DC output voltage during suspension of output oscillation or load change, it might cause output oscillation in a cold environment due to increased capacitor ESR. It is therefore recommended to use a capacitor with small variations temperature sensitivity. The IC may oscillate due to external conditions (output current, temperature, or the type of the capacitor used). The type of capacitor required must be determined by the actual application circuit in which the IC is used.

Usage Precautions

- Low voltage**

Do not apply voltage to the Product that is lower than the minimum operating voltage, or the Product's protective functions will not operate properly and the Product may be permanently damaged.
- Overcurrent Protection**

The overcurrent protection circuits in the Product are designed to temporarily protect Product from minor overcurrent of brief duration. When the overcurrent protective function in the Product activates, immediately cease application of overcurrent to Product. Improper usage of Product, such as application of current to Product exceeding the absolute maximum ratings, could cause the overcurrent protection circuit not to operate properly and/or damage Product permanently even before the protection circuit starts to operate.
- Overheating Protection**

The thermal shutdown circuits in the Product are designed to temporarily protect Product from minor overheating of brief duration. When the overheating protective function in the Product activates, immediately correct the overheating situation. Improper usage of Product, such as the application of heat to Product exceeding the absolute maximum ratings, could cause the overheating protection circuit not to operate properly and/or damage Product permanently even before the protection circuit starts to operate.
- Overvoltage Protection**

The overvoltage protection circuits in the Product are designed to temporarily protect Product from minor overvoltage of brief duration. When the overvoltage protective function in the Product activates, immediately cease application of overvoltage to Product. Improper usage of Product, such as application of voltage to Product exceeding the absolute maximum ratings, could cause the overvoltage protection circuit not to operate properly and/or damage Product permanently even before the protection circuit starts to operate.

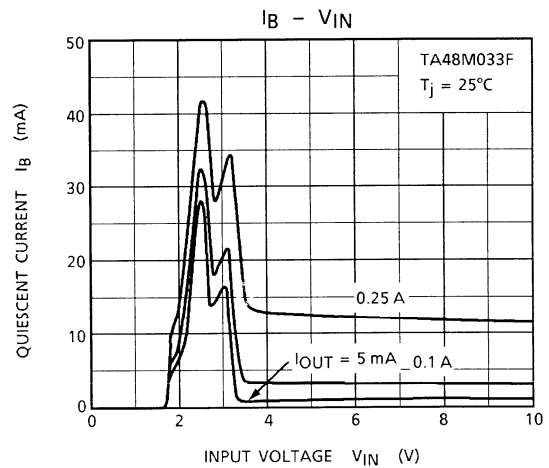
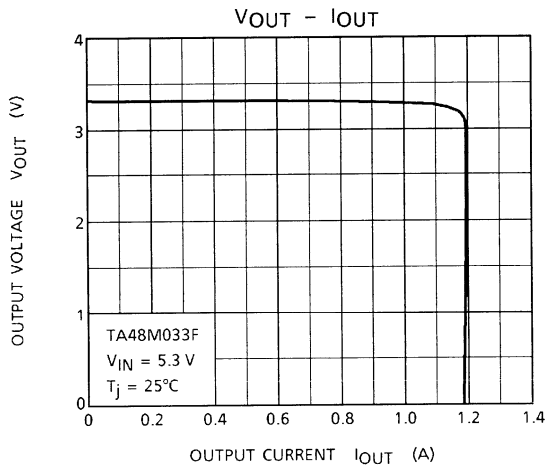
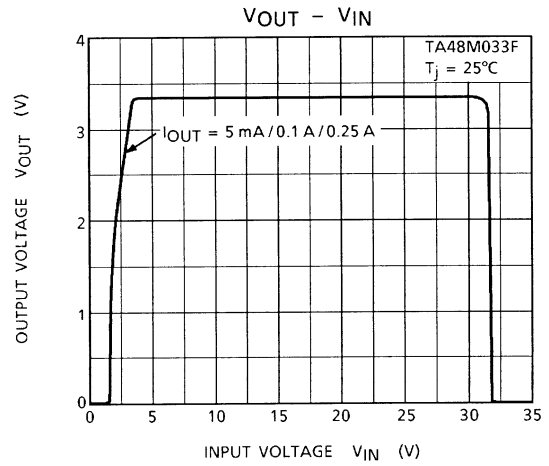
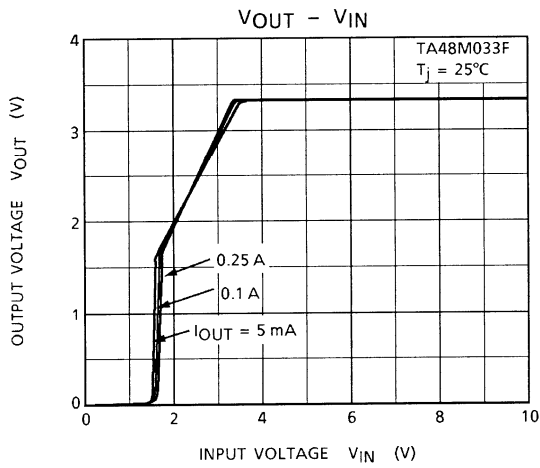
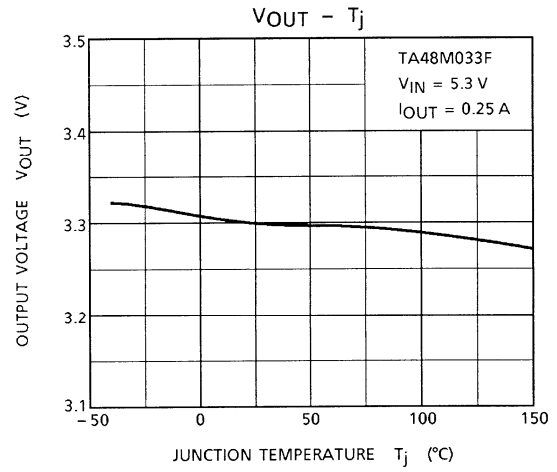
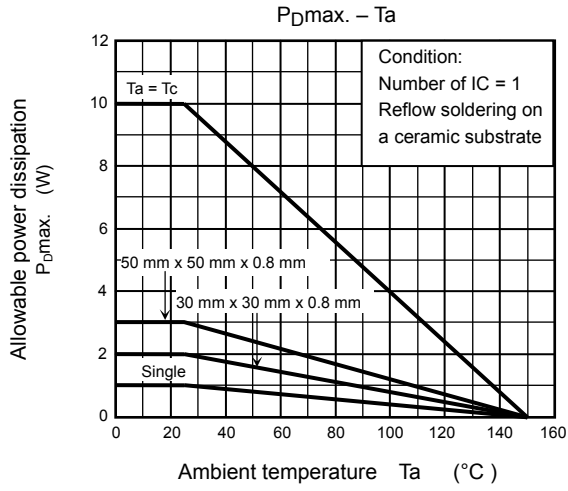

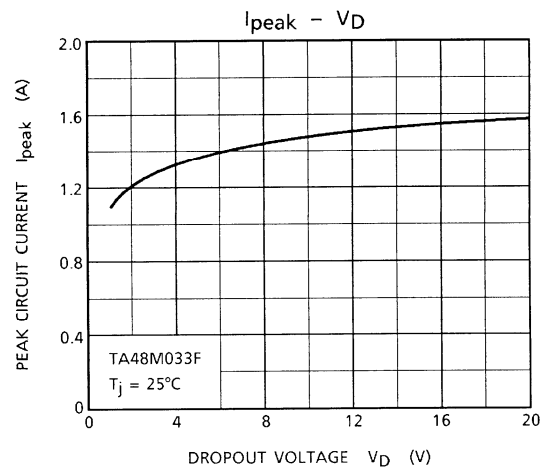
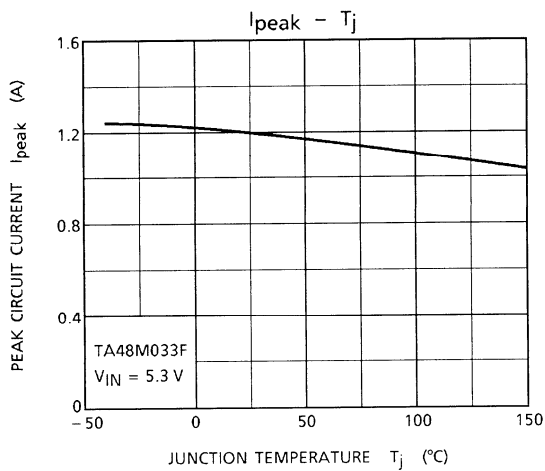
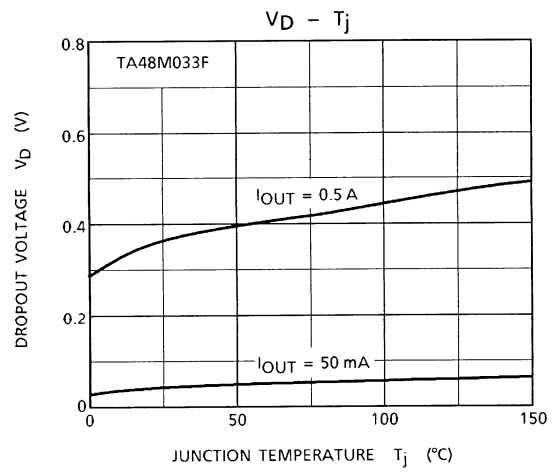
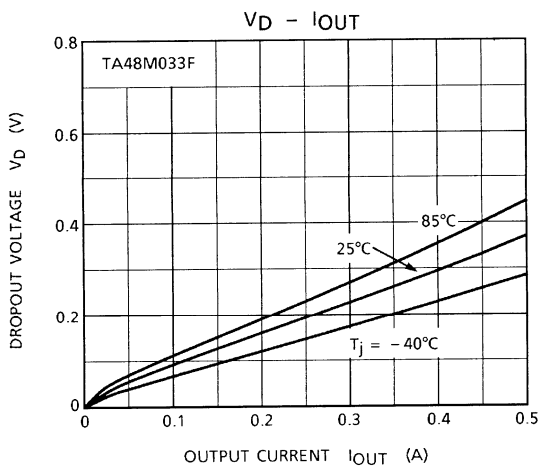
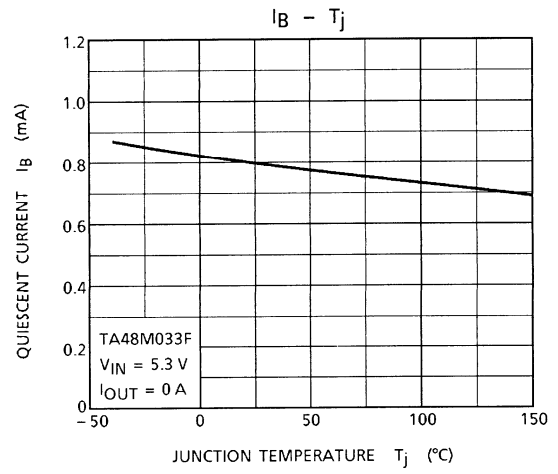
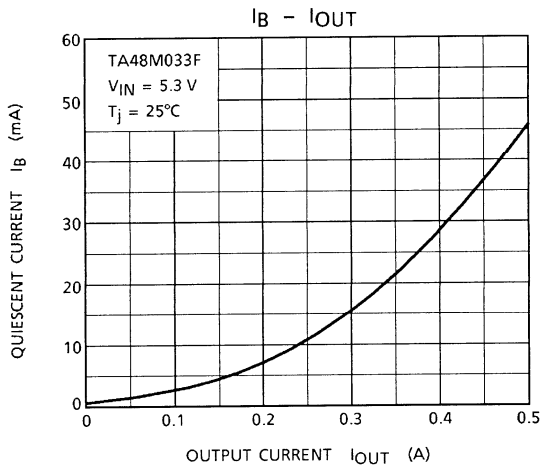

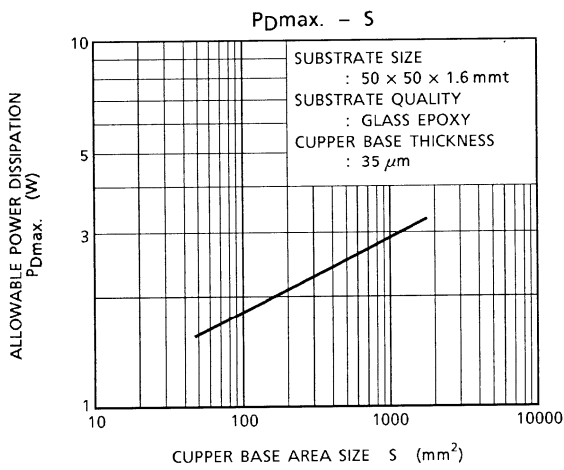
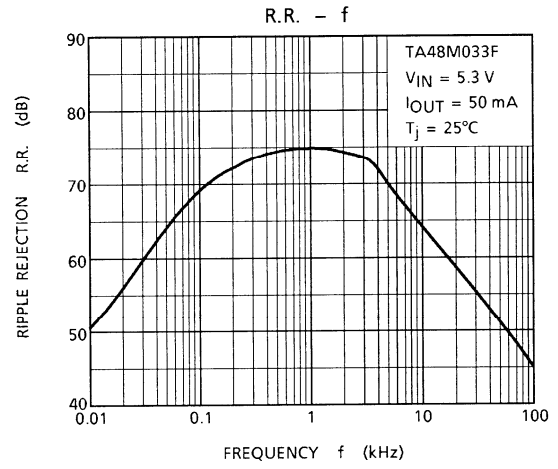
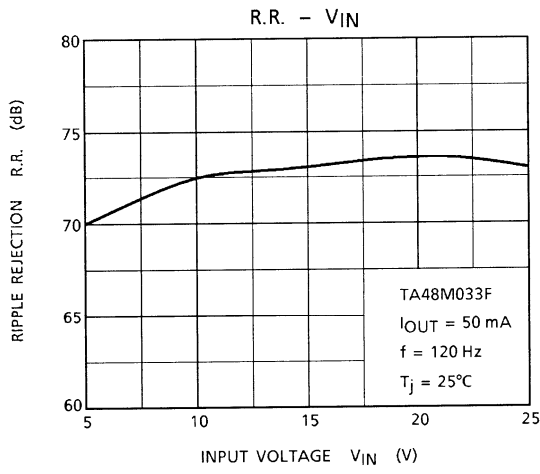

Package Dimensions

HSOP3-P-2.30D

Unit: mm

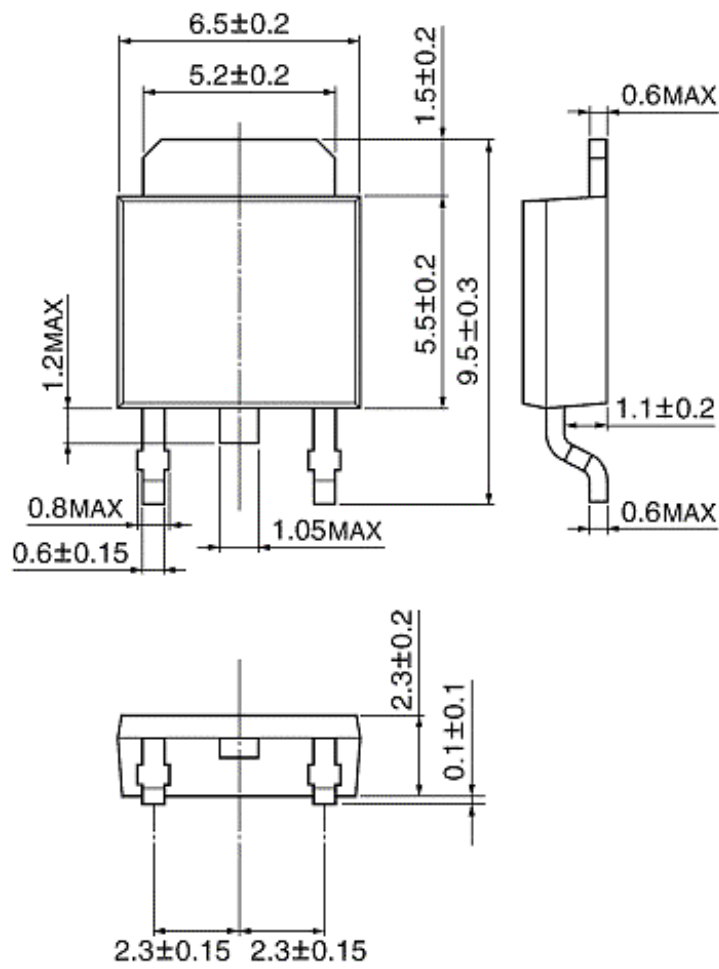

Weight: 0.36 g (typ.)

RESTRICTIONS ON PRODUCT USE

- Toshiba Corporation, and its subsidiaries and affiliates (collectively "TOSHIBA"), reserve the right to make changes to the information in this document, and related hardware, software and systems (collectively "Product") without notice.
- This document and any information herein may not be reproduced without prior written permission from TOSHIBA. Even with TOSHIBA's written permission, reproduction is permissible only if reproduction is without alteration/omission.
- Though TOSHIBA works continually to improve Product's quality and reliability, Product can malfunction or fail. Customers are responsible for complying with safety standards and for providing adequate designs and safeguards for their hardware, software and systems which minimize risk and avoid situations in which a malfunction or failure of Product could cause loss of human life, bodily injury or damage to property, including data loss or corruption. Before creating and producing designs and using, customers must also refer to and comply with (a) the latest versions of all relevant TOSHIBA information, including without limitation, this document, the specifications, the data sheets and application notes for Product and the precautions and conditions set forth in the "TOSHIBA Semiconductor Reliability Handbook" and (b) the instructions for the application that Product will be used with or for. Customers are solely responsible for all aspects of their own product design or applications, including but not limited to (a) determining the appropriateness of the use of this Product in such design or applications; (b) evaluating and determining the applicability of any information contained in this document, or in charts, diagrams, programs, algorithms, sample application circuits, or any other referenced documents; and (c) validating all operating parameters for such designs and applications. **TOSHIBA ASSUMES NO LIABILITY FOR CUSTOMERS' PRODUCT DESIGN OR APPLICATIONS.**
- Product is intended for use in general electronics applications (e.g., computers, personal equipment, office equipment, measuring equipment, industrial robots and home electronics appliances) or for specific applications as expressly stated in this document. Product is neither intended nor warranted for use in equipment or systems that require extraordinarily high levels of quality and/or reliability and/or a malfunction or failure of which may cause loss of human life, bodily injury, serious property damage or serious public impact ("Unintended Use"). Unintended Use includes, without limitation, equipment used in nuclear facilities, equipment used in the aerospace industry, medical equipment, equipment used for automobiles, trains, ships and other transportation, traffic signaling equipment, equipment used to control combustions or explosions, safety devices, elevators and escalators, devices related to electric power, and equipment used in finance-related fields. Do not use Product for Unintended Use unless specifically permitted in this document.
- Do not disassemble, analyze, reverse-engineer, alter, modify, translate or copy Product, whether in whole or in part.
- Product shall not be used for or incorporated into any products or systems whose manufacture, use, or sale is prohibited under any applicable laws or regulations.
- The information contained herein is presented only as guidance for Product use. No responsibility is assumed by TOSHIBA for any infringement of patents or any other intellectual property rights of third parties that may result from the use of Product. No license to any intellectual property right is granted by this document, whether express or implied, by estoppel or otherwise.
- **ABSENT A WRITTEN SIGNED AGREEMENT, EXCEPT AS PROVIDED IN THE RELEVANT TERMS AND CONDITIONS OF SALE FOR PRODUCT, AND TO THE MAXIMUM EXTENT ALLOWABLE BY LAW, TOSHIBA (1) ASSUMES NO LIABILITY WHATSOEVER, INCLUDING WITHOUT LIMITATION, INDIRECT, CONSEQUENTIAL, SPECIAL, OR INCIDENTAL DAMAGES OR LOSS, INCLUDING WITHOUT LIMITATION, LOSS OF PROFITS, LOSS OF OPPORTUNITIES, BUSINESS INTERRUPTION AND LOSS OF DATA, AND (2) DISCLAIMS ANY AND ALL EXPRESS OR IMPLIED WARRANTIES AND CONDITIONS RELATED TO SALE, USE OF PRODUCT, OR INFORMATION, INCLUDING WARRANTIES OR CONDITIONS OF MERCHANTABILITY, FITNESS FOR A PARTICULAR PURPOSE, ACCURACY OF INFORMATION, OR NONINFRINGEMENT.**
- Do not use or otherwise make available Product or related software or technology for any military purposes, including without limitation, for the design, development, use, stockpiling or manufacturing of nuclear, chemical, or biological weapons or missile technology products (mass destruction weapons). Product and related software and technology may be controlled under the Japanese Foreign Exchange and Foreign Trade Law and the U.S. Export Administration Regulations. Export and re-export of Product or related software or technology are strictly prohibited except in compliance with all applicable export laws and regulations.
- Please contact your TOSHIBA sales representative for details as to environmental matters such as the RoHS compatibility of Product. Please use Product in compliance with all applicable laws and regulations that regulate the inclusion or use of controlled substances, including without limitation, the EU RoHS Directive. TOSHIBA assumes no liability for damages or losses occurring as a result of noncompliance with applicable laws and regulations.