

**Major Ratings and Characteristics**

Characteristics	50SQ...	Units
$I_{F(AV)}$ Rectangular waveform	5	A
$V_{RRM}$ range	60 / 100	V
$I_{FSM}$ @ $t_p = 5 \mu s$ sine	1900	A
$V_F$ @ 5 Apk, $T_J = 125^\circ C$	0.52	V
$T_J$ range	-55 to 175	$^\circ C$

**Description/ Features**

The 50SQ... axial leaded Schottky rectifier series has been optimized for low reverse leakage at high temperature. The proprietary barrier technology allows for reliable operation up to 175°C junction temperature. Typical applications are in switching power supplies, converters, free-wheeling diodes, and reverse battery protection.

- 175° C  $T_J$  operation
- High purity, high temperature epoxy encapsulation for enhanced mechanical strength and moisture resistance
- Low forward voltage drop
- High frequency operation
- Guard ring for enhanced ruggedness and long term reliability
- Lead-Free plating

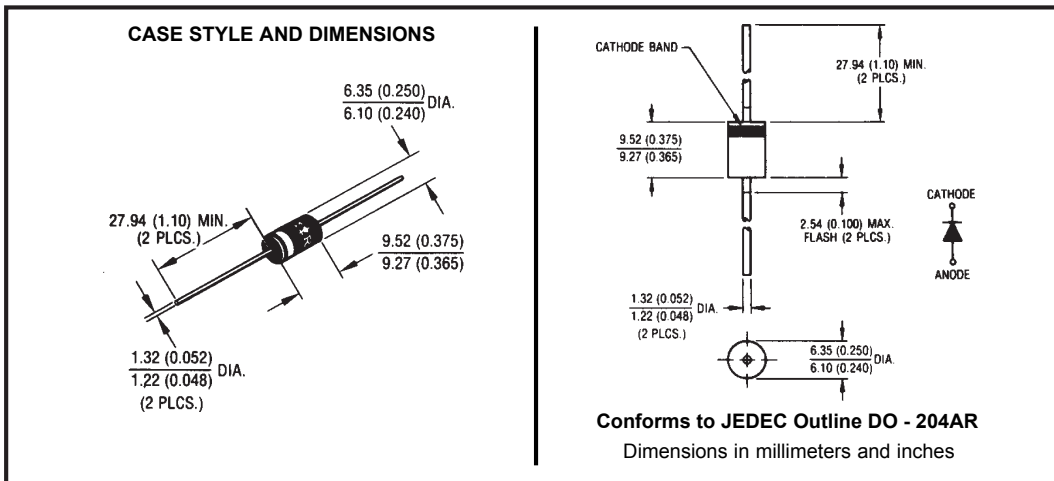

## Voltage Ratings

Part number	50SQ060	50SQ080	50SQ100
$V_R$ Max. DC Reverse Voltage (V)	60	80	100
$V_{RWM}$ Max. Working Peak Reverse Voltage (V)			

## Absolute Maximum Ratings

Parameters	50SQ	Units	Conditions
$I_{F(AV)}$ Max. Average Forward Current * See Fig. 5	5	A	50% duty cycle @ $T_C = 119^\circ\text{C}$ , rectangular wave form
$I_{FSM}$ Max. Peak One Cycle Non-Repetitive Surge Current * See Fig. 7	1900	A	5 $\mu\text{s}$ Sine or 3 $\mu\text{s}$ Rect. pulse
	290		10ms Sine or 6ms Rect. pulse
$E_{AS}$ Non-Repetitive Avalanche Energy	7.5	mJ	$T_J = 25^\circ\text{C}$ , $I_{AS} = 1.0\text{Amps}$ , $L = 15\text{mH}$
$I_{AR}$ Repetitive Avalanche Current	1.0	A	Current decaying linearly to zero in 1 $\mu\text{sec}$ Frequency limited by $T_J$ max. $V_A = 1.5 \times V_R$ typical

## Electrical Specifications

Parameters	50SQ	Units	Conditions
$V_{FM}$ Max. Forward Voltage Drop (1) * See Fig. 1	0.66	V	@ 5A
	0.77	V	@ 10A
	0.52	V	@ 5A
	0.62	V	@ 10A
$I_{RM}$ Max. Reverse Leakage Current (1) * See Fig. 2	0.55	mA	$T_J = 25^\circ\text{C}$
	7	mA	$T_J = 125^\circ\text{C}$
$C_T$ Max. Junction Capacitance	500	pF	$V_R = 5V_{DC}$ , (test signal range 100Khz to 1Mhz) $25^\circ\text{C}$
$L_S$ Typical Series Inductance	10	nH	Measured lead to lead 5mm from body
$dv/dt$ Max. Voltage Rate of Change (Rated $V_R$ )	10000	V/ $\mu\text{s}$	

(1) Pulse Width < 300 $\mu\text{s}$ , Duty Cycle < 2%

## Thermal-Mechanical Specifications

Parameters	50SQ	Units	Conditions
$T_J$ Max. Junction Temperature Range	-55 to 175	$^\circ\text{C}$	
$T_{stg}$ Max. Storage Temperature Range	-55 to 175	$^\circ\text{C}$	
$R_{thJL}$ Max. Thermal Resistance Junction to Lead	8.0	$^\circ\text{C/W}$	DC operation * See Fig. 4 1/8 inch lead length
$R_{thJA}$ Typical Thermal Resistance, Junction to Air	44	$^\circ\text{C/W}$	
wt Approximate Weight	1.4(0.049)	g (oz.)	
Case Style	DO-204AR		JEDEC

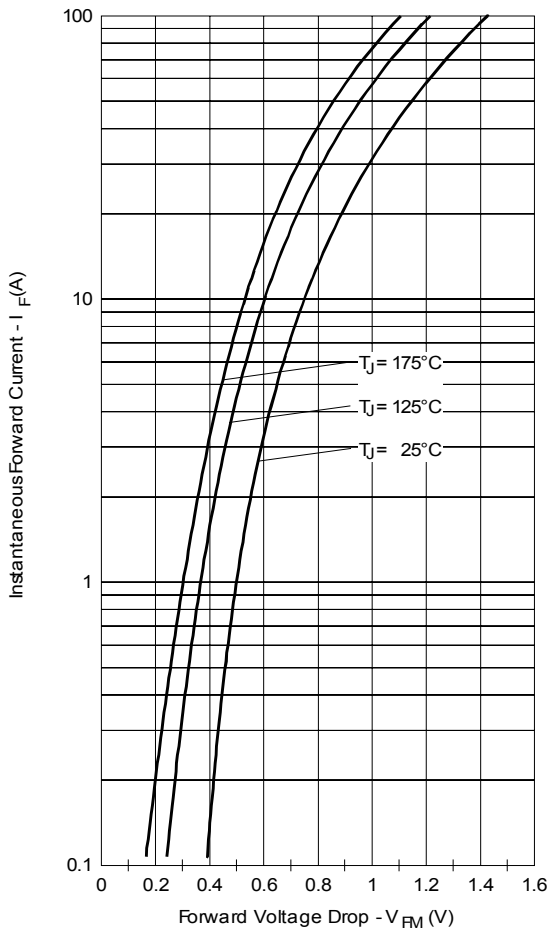

Fig. 1 - Maximum Forward Voltage Drop Characteristics

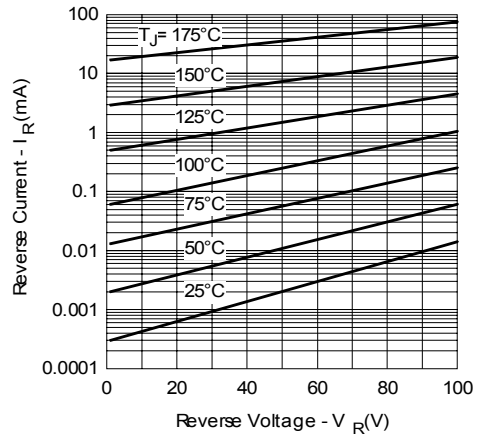

Fig. 2 - Typical Values of Reverse Current Vs. Reverse Voltage

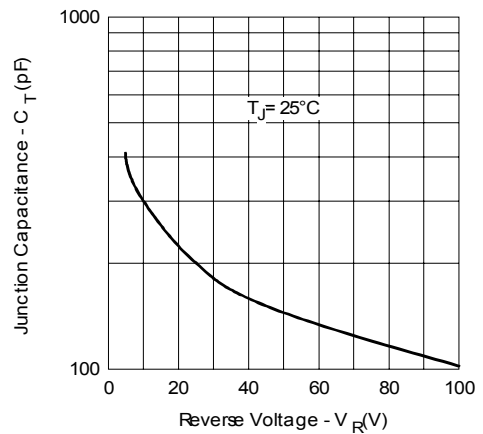

Fig. 3 - Typical Junction Capacitance Vs. Reverse Voltage

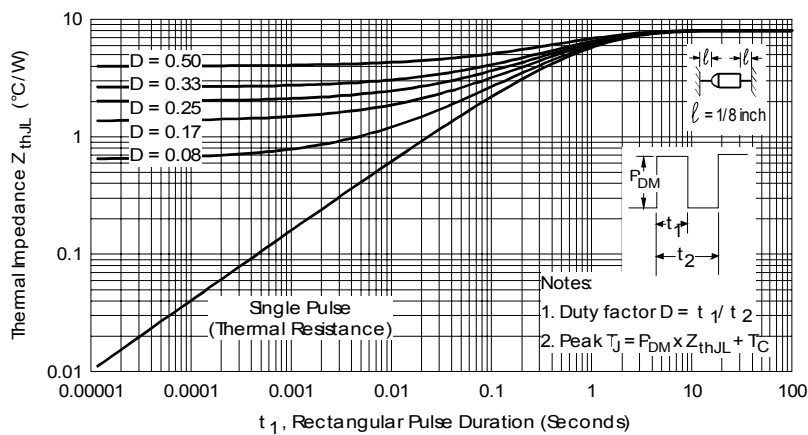

Fig. 4 - Maximum Thermal Impedance  $Z_{thJL}$  Characteristics

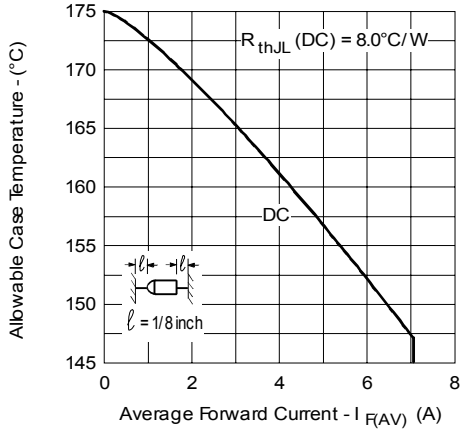

Fig. 5 - Maximum Allowable Case Temperature Vs. Average Forward Current

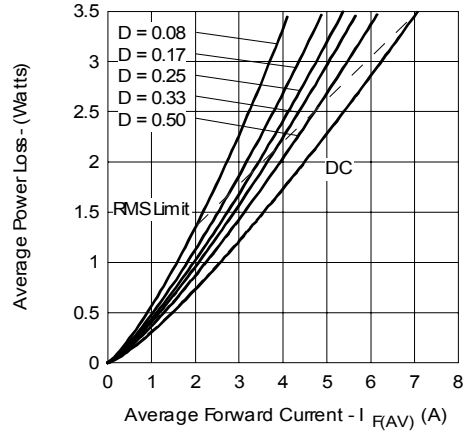

Fig. 6 - Forward Power Loss Characteristics

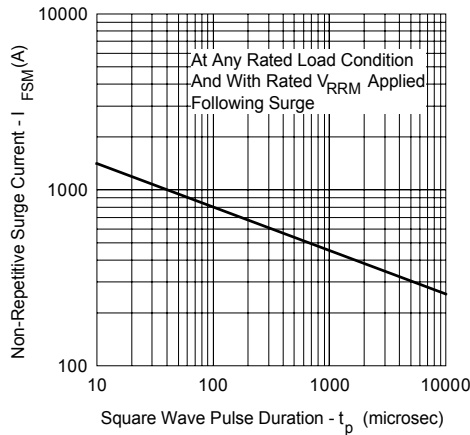

Fig. 7 - Maximum Non-Repetitive Surge Current

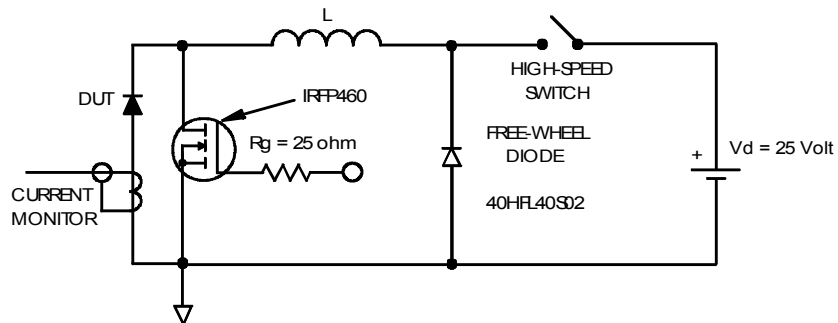

Fig. 8 - Unclamped Inductive Test Circuit

Ordering Information Table

Device Code											
	<table border="1" style="margin: auto;"> <tr> <td style="padding: 5px;">50</td> <td style="padding: 5px;">S</td> <td style="padding: 5px;">Q</td> <td style="padding: 5px;">100</td> <td style="padding: 5px;">TR</td> </tr> <tr> <td style="text-align: center;">①</td> <td style="text-align: center;">②</td> <td style="text-align: center;">③</td> <td style="text-align: center;">④</td> <td style="text-align: center;">⑤</td> </tr> </table>	50	S	Q	100	TR	①	②	③	④	⑤
50	S	Q	100	TR							
①	②	③	④	⑤							
<b>1</b>	- 50 = current x 10										
<b>2</b>	- S = DO-204AR										
<b>3</b>	- Q = Schottky Q Series										
<b>4</b>	- Voltage Rating										
<b>5</b>	- TR = Tape & Reel package (1500 pcs) - = Box package (200 pcs)										

060 = 60V
080 = 80V
100 = 100V

Data and specifications subject to change without notice.  
 This product has been designed and qualified for Industrial Level and Lead-Free.  
 Qualification Standards can be found on IR's Web site.