

SCHOTTKY RECTIFIER

5.5 Amp

Major Ratings and Characteristics

Characteristics	50WQ..F	Units
$I_{F(AV)}$ Rectangular waveform	5.5	A
V_{RRM}	90/100	V
I_{FSM} @ $t_p = 5 \mu s$ sine	210	A
V_F @ 5 Apk, $T_J = 25^\circ C$	0.93	V
T_J	-40 to 125	$^\circ C$

Description/Features

The 50WQ..F surface mount Schottky rectifier has been designed for applications requiring low forward drop and small foot prints on PC board. Typical applications are in disk drives, switching power supplies, converters, free-wheeling diodes, battery charging, and reverse battery protection.

- Popular D-PAK outline
- Small foot print, surface moutable
- Low forward voltage drop
- High frequency operation
- Guard ring for enhanced ruggedness and long term reliability

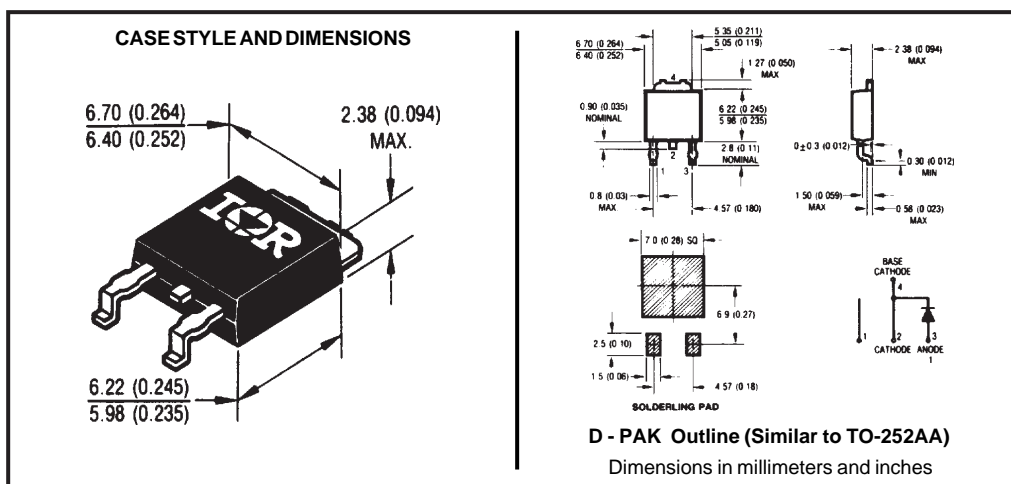

Voltage Ratings

Part number	50WQ09F	50WQ10F
V_R Max. DC Reverse Voltage (V)	90	100
V_{RWM} Max. Working Peak Reverse Voltage (V)		

Absolute Maximum Ratings

Parameters	50WQ..F	Units	Conditions
$I_{F(AV)}$ Max. Average Forward Current * See Fig. 5	5.5	A	50% duty cycle @ $T_C=90^\circ\text{C}$, rectangular wave form
I_{FSM} Max. Peak One Cycle Non-Repetitive Surge Current * See Fig. 7	210	A	5 μs Sine or 3 μs Rect. pulse
	42		10ms Sine or 6ms Rect. pulse
			Following any rated load condition and with rated V_{RWM} applied

Electrical Specifications

Parameters	50WQ..F	Units	Conditions
V_{FM} Max. Forward Voltage Drop * See Fig. 1 (1)	0.93	V	@ 5A
	1.08	V	@ 10A
	0.77	V	@ 5A
	0.89	V	@ 10A
I_{RM} Max. Reverse Leakage Current * See Fig. 2 (1)	1	mA	$T_J = 25^\circ\text{C}$
	3	mA	$T_J = 125^\circ\text{C}$
C_T Typical Junction Capacitance	100	pF	$V_R = 5V_{DC}$, (test signal range 100Khz to 1Mhz) 25°C
L_S Typical Series Inductance	5.0	nH	Measured lead to lead 5mm from package body

(1) Pulse Width < 300 μs , Duty Cycle < 2%

Thermal-Mechanical Specifications

Parameters	50WQ..F	Units	Conditions
T_J Max. Junction Temperature Range	-40 to 125	$^\circ\text{C}$	
T_{stg} Max. Storage Temperature Range	-40 to 125	$^\circ\text{C}$	
R_{thJC} Max. Thermal Resistance Junction to Case	6.0	$^\circ\text{C}/\text{W}$	DC operation * See Fig. 4
wt Approximate Weight	0.3(0.01)	g(oz.)	
Case Style	D - PAK		Similar to TO-252AA

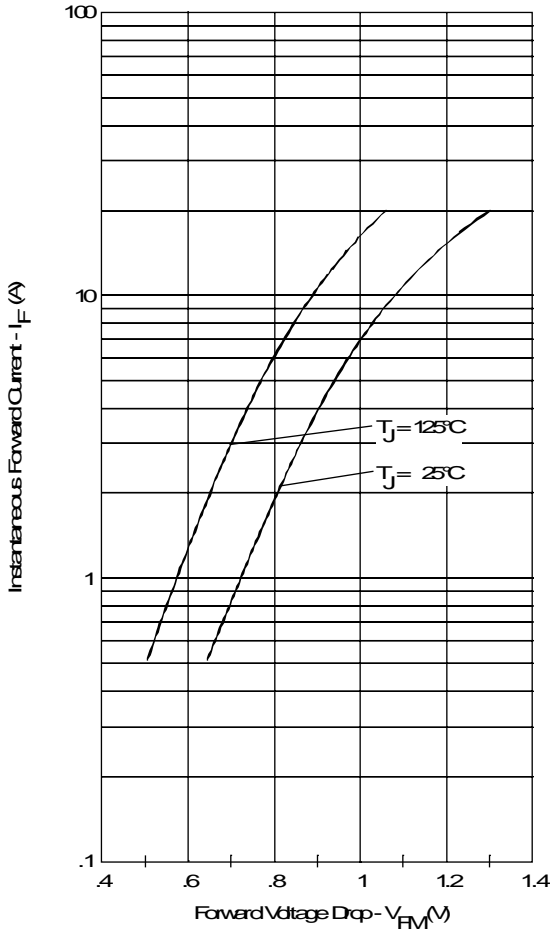

Fig. 1 - Maximum Forward Voltage Drop Characteristics

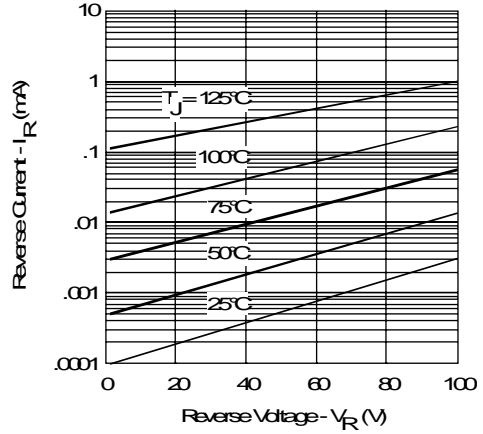

Fig. 2 - Typical Values of Reverse Current Vs. Reverse Voltage

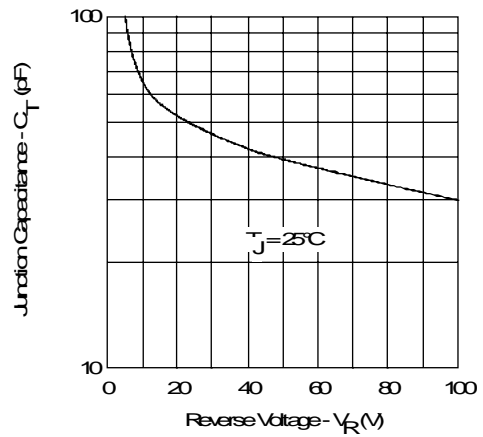

Fig. 3 - Typical Junction Capacitance Vs. Reverse Voltage

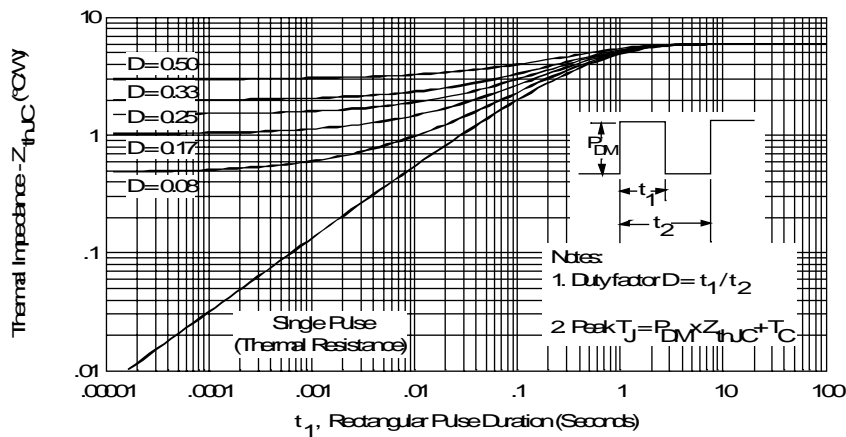

Fig. 4 - Maximum Thermal Impedance Z_{thJC} Characteristics

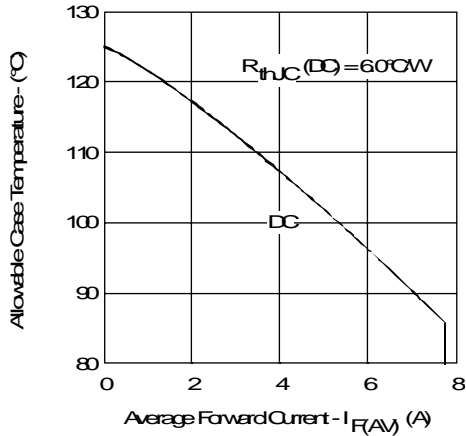

Fig. 5 - Maximum Allowable Case Temperature Vs. Average Forward Current

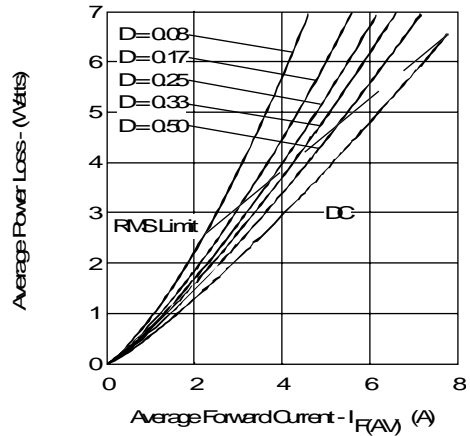

Fig. 6 - Forward Power Loss Characteristics

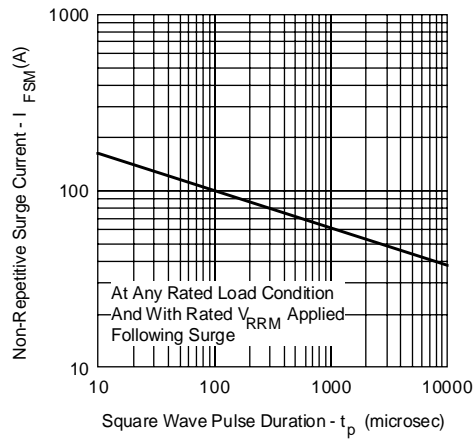

Fig. 7 - Maximum Non-Repetitive Surge Current