

5242300

ARINC 629

SERIAL INTERFACE MODULE (SIM)

- ❑ Interfaces To All Current Mode Couplers (CMC) (SCI P/N 5242500)
- ❑ Supports Stub Lengths to 40 Meters
- ❑ High Speed Operation (Transmit $P_d < 39$ ns)
- ❑ Transmit Integrity Checking w/ Wrap Around Signal Monitoring
- ❑ Power Control for Coupler w/ Over-Current Protection
- ❑ Manages Coupler Redundant Channel Selection
- ❑ Fault Detection, Isolation and Reporting Capabilities
- ❑ Self-Test Capabilities
- ❑ 28 Pin Double-Dip Package
- ❑ MIL-H-38534 Screened

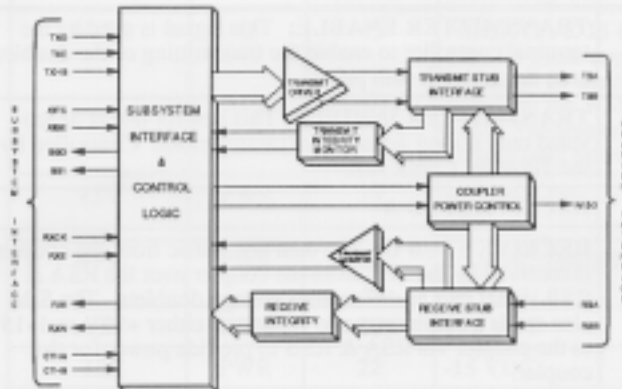

Fig 1. 5242300 Block Diagram

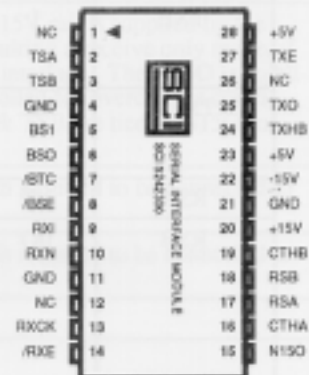

Fig 2. 5242300 Pin Description

GENERAL OVERVIEW

The 5242300 Serial Interface Module (SIM) interfaces the Terminal Controller and its associated subsystem to the Current Mode Coupler (SCI# 5242500). The SIM and Coupler interface provides the user the capability to operate a twisted pair current mode serial data bus per the ARINC 629 standard. The SIM provides high speed Manchester to doublet logic encoding for transmission to the coupler over the stub interface and performs high speed Manchester regeneration of the data bus traffic received from the coupler.

The SIM controls the modes of operation of the current mode coupler by monitoring the doublet signals it transmits to the coupler and those signals transmitted on the twisted wire data bus by the coupler. In the event of a faulty transmit signal in the primary channel of the coupler, the SIM will instruct the coupler to switch to a secondary redundant transceiver channel. Should a SIM transmit failure occur, the SIM will disable further attempted transmission until a rising and following transition of TXHB has occurred. The SIM controls power to the coupler and will remove power from the coupler in the event of an overcurrent condition.

Table 1. PIN DESCRIPTION:

PIN NAME	I/O	PIN#	FUNCTION
TSA	O	2	TRANSMIT STUB A
TSB	O	3	TRANSMIT STUB B: The transmit stub pair TSA & TSB are connected to the current mode coupler via a stub cable. The transmit data is sent from the SIM to the Coupler as differential voltage doublets over this pair. A common mode voltage of either +15V or -15V is also sent to the coupler over this pair to provide power for its operation.
TXO	I	25	TRANSMITTER OUTPUT: This is TTL transmit data from the terminal controller. The Manchester encoded data is asynchronously converted to doublet logic for transmission to the Current Mode Coupler via TSA & TSB.
TXE	I	27	TRANSMITTER ENABLE: This signal is used by the terminal controller to enable the transmitting of the doublets onto the transmit stub pair.
TXHB	I	24	TRANSMITTER INHIBIT: This control line is deactivated only during actual data transmissions. Controlled by the Terminal Controller.
RSA	I/O	17	RECEIVE STUB A
RSB	I/O	18	RECEIVE STUB B: The data bus traffic from the coupler is received by the SIM from the coupler over the RSA & RSB signal pair as differential voltage doublets. The SIM also sends a common mode voltage of either +15V and -15V to the coupler via RSA & RSB to provide power for the coupler.
/RXE	I	14	RECEIVE ENABLE: The output signal lines RXI & RXN are tristated unless /RXE is held low.

Table 1. PIN DESCRIPTION (cont.)

PIN NAME	I/O	PIN#	FUNCTION
RXCK	I	13	RECEIVE DATA CLOCK: This clock is the receive data clock which is extracted from the incoming bit stream and is generated by the Terminal Controller. Its frequency equals twice the incoming bit rate. (RXCK = 4Mhz for 2Mbit implementation.)
RXI	O	9	RECEIVER OUTPUT
RXN	O	10	RECEIVER OUTPUT NOT: The output signal lines RXI & RXN are used by the SIM to signal the two-line Manchester biphasic, TTL compatible data which is regenerated from the incoming doublets to the Terminal Controller. Bus quiet conditions of the current mode data bus are indicated by both output lines going low.
CTHA	I	16	COMPARATOR THRESHOLD A
CTHB	I	19	COMPARATOR THRESHOLD B: The control signal lines CTHA & CTHB are used to control the SIM receiver input doublet threshold. Grounding both pins sets the input threshold for the higher noise immunity condition. Both pins high select the lower input threshold condition. Both pins are required to be in the same state or the SIM transmit is disabled. (N/c = HIGH)
/BTC	I	7	BITE COMMAND: The falling edge of BTC asserts the BITE (Built In Test) sequence. (See Table 2).
/BSE	I	8	BITE STATUS ENABLE: Enables the BITE STATUS OUTPUTS BS0 & BS1. A high on /BSE tristates the status outputs.
BS0	O	6	BITE STATUS 0
BS1	O	5	BITE STATUS 1: The status lines BS0 & BS1 are used to indicate the status of the SIM and the two redundant channels in the coupler. The status indicates the results of the most recent BITE command. (See Table 2). The BITE command and status lines are used by the subsystem and are not used by the Terminal Controller.
N150	O	15	NEGATIVE 15 OUT: This -15V rail is supplied by the SIM for those applications requiring a receive only mode of operation by the SIM/Coupler interface. The N150 is conditioned by the SIM and is controlled for overcurrent conditions. The transmit stub TSA & TSB are tied to N150 for receive only operation.
+5V	PWR	23	+5 VDC: Pins 23 & 28 are both required to be connected to +5V.
+5V	PWR	28	+5 VDC: Pins 23 & 28 are both required to be connected to +5V.
+15V	PWR	20	+15 VDC
-15V	PWR	22	-15 VDC
GND	GND	4 11, 21	GROUND: Pins 4, 11 & 21 are all three required to be connected to PCB ground.
NC	-	1 12 26	NO CONNECT: These pins are not to be connected.

OPERATION

The 5242300 Serial Interface Module is used in conjunction with a Current Mode Coupler (SCI 5242500) to interface a Terminal Controller to the ARINC 629 current mode data bus. The Terminal Controller transmits Manchester biphase data to the SIM.

The SIM performs the data translation and the transfer functions required for bidirectional interfacing to the current mode coupler connected to the twisted wire data bus. The SIM has three main functions: 1) Data Translation and Transfer, 2) Coupler Mode Control and 3) Fault Management and BITE.

DATA TRANSLATION AND TRANSFER

Transmit

The current mode data bus requires that the transmit digital information be converted to an AC signal in order to be transmitted over the bus. This is achieved in the SIM by converting each transition of the transmit biphase Manchester data from the terminal into a "doublet". This is then sent by the SIM to the coupler (via TSA & TSB) for transmission onto the current mode data bus. A voltage "doublet" is defined as balanced differential signal made up of a pair of positive and negative voltage excursions (fig. 3). The doublet excursions are 62.5 nanoseconds wide with a differential amplitude of approximately ± 4.5 volts.

The SIM performs the high speed logic translation in less than 30 ns typically. The SIM monitors the transmission of each doublet to the coupler for proper amplitude and symmetry. Should the transmit monitoring circuitry of the SIM detect a faulty transmit doublet the SIM will indicate a transmit failure and inhibit the transmit function (See Fault Management & BITE). This is to insure that the terminal interface does not corrupt the data bus with inaccurate signaling. The transmitted doublets are also monitored by the SIM on the receive section to evaluate the performance of the coupler transmit function (See Receive, Coupler Mode Control).

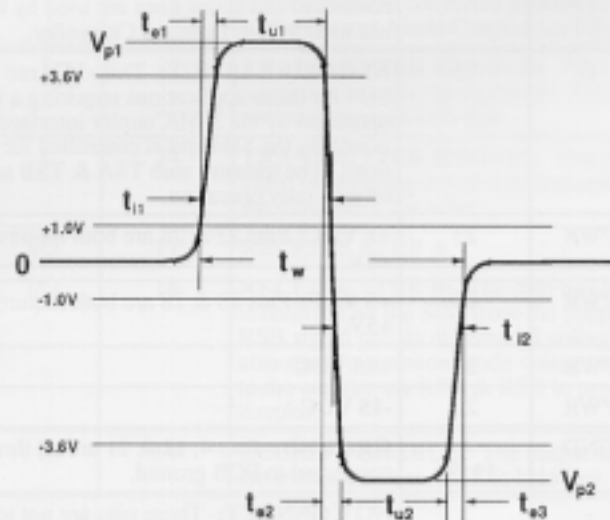

Figure 3. 5242300 SIM Transmit Doublet

Receive

The SIM receives voltage doublets from the coupler as they are picked up from the twisted pair data bus as current doublets. Although the coupler receiver is an active amplifier, it has a fixed gain. Therefore, the amplitude of the doublet received by the SIM from the coupler is indicative of the bus doublet amplitude. It is this feature, along with the fact that the coupler receives its own transmit onto the data bus, that allows the SIM to perform data bus signal analysis of its own transmitted signal. (See Fault Management & BITE). The SIM analyzes each incoming doublet and checks the signal for the proper waveform symmetry and amplitude. The acceptable amplitude is determined by whether the signal was a result of the couplers own transmit or whether it was data from a distant terminal. The receive doublets from distant terminals are required to satisfy one of two amplitudes depending on the status of

the CTHA & CTHB control lines. This allows for those ARINC 629 systems with few couplers and shorter bus lengths to be configured for higher noise immunity. In order to reduce delays in the data translation and transfer function the SIM regenerates the Manchester biphasic data transition to the Terminal Controller as soon as the incoming doublet is detected. Should the doublet turn out to be defective or erroneous the SIM will suppress the next two transitions of the incoming Manchester data. The Terminal Controller will detect that the transitions have been suppressed. The SIM determines the end of a message on the twisted wire data bus by counting four (4) consecutive rising edges of RXCK clock without the receipt of a doublet from the coupler. The SIM will then assume a bus quiet condition (RXI & RXN low).

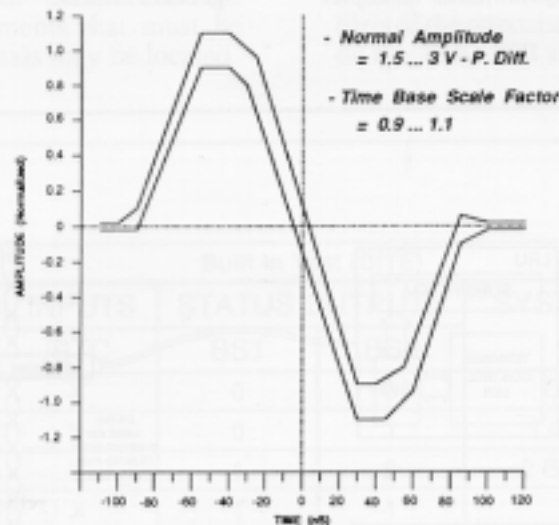

Figure 4. 5242300 SIM Receive Doublet

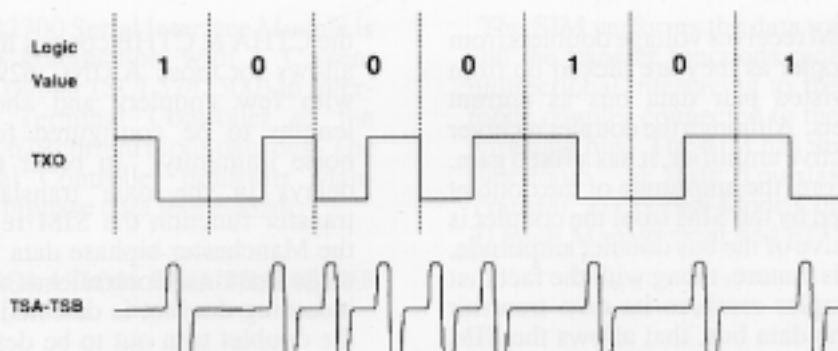

Figure 5. SIM Doublet Signaling

Power Control

The SIM controls and monitors the power used by the current mode coupler. The coupler is powered by +15 VDC and -15 VDC supply rails that are supplied via the stub interface cable. The voltage rails are supplied to the coupler as common mode voltages on the transmit and receive signal pairs. The SIM determines which voltage rail to place on which stub signal pair based on the desired mode of operation of the current mode coupler. (See Coupler Mode Control).

The SIM monitors the power consumption of the coupler for overcurrent conditions. Should an overcurrent condition occur the voltage rails are removed from the coupler until the SIM is reset via a positive edge of TXE or RXE. The over current condition is defined as a continuous current drain of 750 milliamps for 32 usec. Although the coupler does not use ground the SIM can detect both rail to rail or rail to ground shorts.

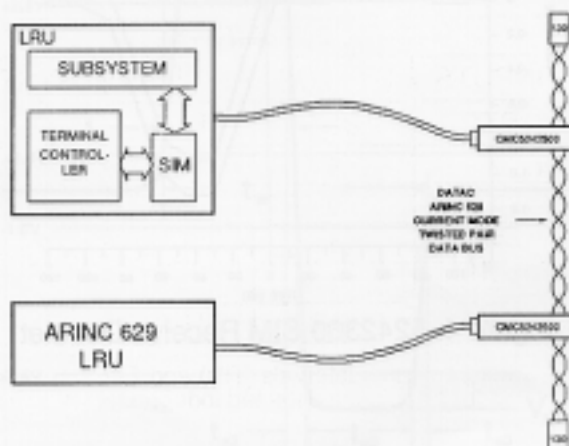

Figure 6. 5242300 SIM Application

FAULT MANAGEMENT & BITE

Fault Detection

The SIM constantly monitors the operation of the SIM and Coupler to insure the integrity of the data that is transmitted on the twisted wire data bus. The SIM checks its own transmit as it is sent to the coupler to insure that signaling is of sufficient amplitude and symmetry. Should a failure occur in the SIM transmit signaling then the SIM will temporarily disable the SIM transmitter and log the error for BITE inquiries. The SIM will attempt to transmit data again following the next rising and falling edge of TXHB. The SIM monitors all receive signaling for proper amplitude and intradoublet gap time. However, when the SIM is transmitting doublets to the coupler, the doublets received by the SIM from the Coupler are treated differently than doublets received from distant terminals. The difference between doublets received from distant terminals and those that are received as a result of the SIMs own coupler transmit is the amplitude requirements that must be met. Distant terminals may be located

up to 100 meters away and the SIM must be able to detect the lowest amplitude of a worst case transmitting coupler. The normal threshold for receive doublets at the SIM is 700 mV (unless modified by CTHA & CTHB). As the SIM's own coupler transmits doublets (as indicated by TXHB being low at the SIM) the signals are immediately sensed by its receiver and are sent on to the SIM with much larger amplitudes. These wraparound doublets are required to satisfy a higher voltage threshold in order to be considered acceptable (1400 mV). The data bus signaling amplitude is critical to insure that the signal is being received with sufficient amplitude at a distant coupler. In the event that the SIM detects that faulty doublets are being transmitted onto the data bus, the SIM will request that the coupler switch to a redundant secondary transceiver channel. The SIM signals the coupler to utilize the backup channel by transmitting doublets of the opposite phase to the coupler on the TSA-TSB signal lines.

Built In Test (BITE)				
CONTROL INPUTS		STATUS OUTPUTS		SYSTEM STATUS
/BSE	/BTC	BS1	BS0	
0	X	0	0	Coupler Fault
0	\	0	1	1 Good Channel
0	\	1	0	2 Good Channels
0	X	1	1	No Test ¹
1	X	Hi-Z	Hi-Z	No Test

Note 1 : If the BS(1:0) are read after 3 transmit intervals (TI's) and TXE has gone low and their value is 11, then this gives indication that a SIM fault has been detected independent of any other /BTC resultant status.

Table 2. SIM BITE Status Codes

FAULT MANAGEMENT & BITE (cont.)
Coupler Mode Control

The SIM has the ability to control the mode of operation of the coupler in two ways. First, the SIM can configure the coupler to use a secondary transceiver channel if the SIM detects a fault with the primary. This is done by transmitting doublets of opposite phase to the coupler (see Figure 8). Secondly, the SIM can configure the coupler in a receive only mode of operation. This is done by reversing the common mode voltages that are sent to power the coupler via the transmit and receive stub signal pairs. Table 3 indicates the various SIM and coupler modes of operation. The SIM will automatically man-

age the coupler mode of operation. The subsystem user can obtain SIM and coupler status information by executing the Built In Test (BITE) capabilities of the interface. The BITE sequence is executed by activating the /BTC signal. The SIM will perform the test on the SIM and both of the channels in the coupler and report the results via the BS0 & BS1 status bits. The time required for the SIM to execute the BITE sequence may require more than one TI (Transmit Interval) to execute. The SIM will report "no test" until the sequence is complete as indicated in Table 2.

SIM TRANSMIT FUNCTION & COUPLER MODE CONTROL						
CONTROL INPUTS			INTERNAL STATUS ⁷		CONTROL STATUS	
TXE	TXHB	/RXE	SIM FAULT	COUPLER FAULT	SIM TRANSMIT FUNCTION	COUPLER POWER
1	0	X	0	0	Enabled ¹	Normal ²
0	X	0	X	X	Disabled ³	Rcv Only ⁴
0	X	1	X	X	Disabled	Unit Off ⁵
X	1	X	X	X	Disabled	note 6
X	X	0	1	X	Disabled	Rcv Only
X	X	1	1	X	Disabled	Unit Off
X	X	0	X	1	Disabled	Rcv Only
X	X	1	X	1	Disabled	Unit Off

NOTES:

1. Enabled indicates that the SIM will transmit doublets to the coupler via the stub cable.
2. In Normal operation +15 VDC is sent to the coupler via TSA-TSB and -15 VDC is sent via RSA-RSB.
3. The transmit function is disabled and no doublets will be generated.
4. The coupler is placed in receive only mode by supplying +15 VDC to the coupler via RSA-RSB and -15 VDC via TSA-TSB. (Reverse of normal)
5. The SIM completely removes coupler power from the stub cable.
6. Dependent on state of TXE, RXE.
7. Internal status only, not available at SIM external pin interface

Table 3. SIM Transmit Function & Coupler Mode Control

The internal status lines are those control signals within the SIM which are used in conjunction with the external control inputs to determine allowance of SIM transmit and coupler power. A SIM fault is declared if an internal transmit error flag has been set by the

fault management logic when a falling edge transition of TXE is seen. A coupler fault is set by the fault management logic after it has executed unsuccessful sequences of transmission on both channels.

ABSOLUTE MAXIMUM RATINGS*

Case Temperature -40°C to +125°C
 Storage Temperature -65°C to +150°C
 Voltage on Any Pin
 with Respect to Ground -1.0V to +7V
 Power Dissipation
 1.3W

*Notice: Stresses above those listed under "Absolute Maximum Rating" may cause permanent damage to the device. This is a stress rating only and functional operation of the device at these or any other conditions above those indicated in the operations sections of this specification is not implied. Exposure to absolute maximum rating conditions for extended periods may affect device reliability.

NOTICE: Specifications contained within the following tables are subject to change

D.C CHARACTERISTICS $T_c = -40^\circ\text{C}$ to $+125^\circ\text{C}$, $V_{cc} = 5\text{V} \pm 5\%$

Symbol	Parameter	Min	Max	Units	Test Conditions
V_L	Input Low Voltage		0.8	V	
V_{IH}	Input High Voltage	2.0		V	
V_{OL}	Output Low Voltage		0.45	V	$I_{OL} = 4.8\text{ mA}$
V_{OH}	Output High Voltage	2.4 $V_{CC} - 0.4$		V	$I_{OH} = -1.3\text{ mA}$ $I_{OH} = -100\text{ uA}$
I_L	Input Low Current		-0.2	mA	$V_{CC} = \text{Max}$, $V_I = 0.4\text{ VDC}$
I_H	Input High Current		25	uA	$V_{CC} = \text{Max}$, $V_I = 2.7\text{ VDC}$
I_{OL}	Output Low Current		24	ma	
I_{OH}	Output High Current		-3.2	mA	
I_L	Input Leakage Current		± 10	uA	$0\text{V} < V_{in} < V_{cc}$
C_{IO}	Output or I/O Capacitance		15	pF	
I_{CC}	Power Supply Current +5		200	mA	Continuous Transmit Worst Case 2MHz Manchester Data
I_{CC}	+15 -15		20 20	mA mA	Does Not Include CMC Current. $\pm 5\%$

A.C CHARACTERISTICS $T_c = -40^{\circ}\text{C}$ to $+125^{\circ}\text{C}$, $V_{cc} = 5\text{V} \pm 5\%$

Symbol	Parameter	Min	Max	Units	Test Conditions
V_{p1}	Transmit Peak Amplitude, 1st lobe	3.9	6.0	V	TSA-TSB Differential
V_{p2}	Transmit Negative Peak	-3.9	-6.0	V	TSA-TSB Differential
t_{e1}	Time, Edge 1 (+1.0V to +3.6V)	3.75	11	ns	
t_{e2}	Time, Edge 2 (+3.6V to -3.6V)	6.2	19.9	ns	
t_{e3}	Time, Edge 3 (-3.6V to -1.0V)	5	16	ns	
t_{l1}	Transmit Width, 1st lobe, lower (+1.0V)	59.16	70.37	nS	
t_{l2}	Transmit Width, 2nd lobe, lower (-1.0V)	54.09	71.92	nS	
t_{l1}	Transmit Width, 1st lobe, upper (+3.6V)	46.13	60.8	nS	
t_{l2}	Transmit Width, 2nd lobe, upper (-3.6V)	42.97	60.4	nS	
t_w	Transmit Doublet Width (+1.0V to -1.0V)	129.0	138.58	nS	
t^{pd}	Transmit Propagation Delay		39	nS	Measured to 10% Point of first Half Doublet
r^{pd}	Receive Propagation Delay		36	nS	Measured from first threshold crossing to Manchester regeneration

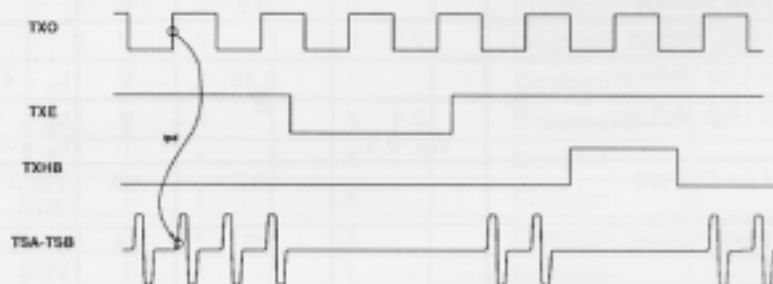

Figure 7. SIM Transmit Function

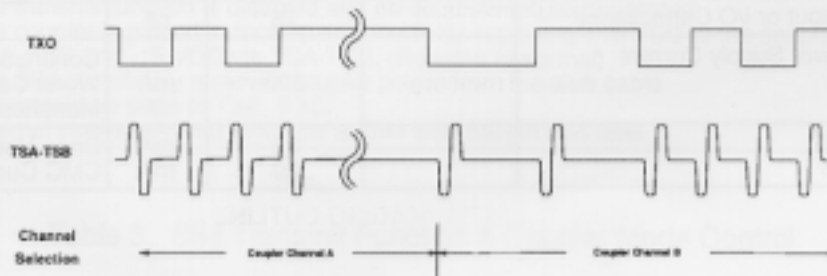
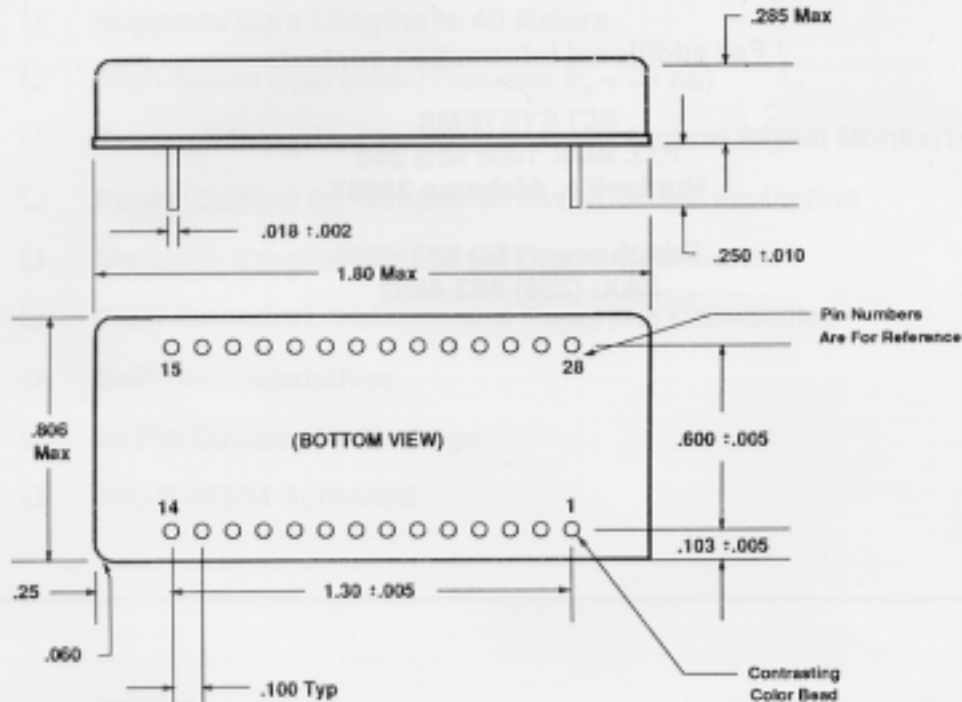

Figure 8. SIM Coupler Channel Select

SIM PACKAGING:

MECHANICAL OUTLINE 28 PIN DOUBLE DIP



NOTES:

1. Dimensions shown are in inches with tolerances to two or three places
2. Lead identification numbers are for reference only
3. Lead cluster shall be centered within 0.010 of outline dimensions. Lead spacing dimensions apply only at seating plane.
4. Pin material meets solderability requirements of MIL-STD-202E, Method 208C or MIL-STD-883C.
5. Package is Nickel Plated Kovar.
6. Quality Assurance Program - Boeing D1-9000.

Figure 9. SIM PACKAGING OUTLINE

AC CHARACTERISTICS T_a = +25°C to -55°C, V_{CC} = 5V, V_{EE} = 0V

Symbol	Parameter	Min	Max	Units	Test Conditions
V _{OL}	Tri-state Peak Amplitude, 100 kHz	0.0	0.5	V	Maximum BST-AST
V _{OL}	Tri-state Signal Amplitude				Maximum BST-AST
t _{PL}	Time, Edge 1 (1-1.5V)			ns	
t _{PH}	Time, Edge 2 (1.5-2.0V)			ns	
t _{PL}	Time, Edge 3 (2.0-2.5V)			ns	
t _{PH}	Time, Edge 4 (2.5-3.0V)			ns	
t _{PL}	Time, Edge 5 (3.0-3.5V)			ns	
t _{PH}	Time, Edge 6 (3.5-4.0V)			ns	
t _{PL}	Time, Edge 7 (4.0-4.5V)			ns	
t _{PH}	Time, Edge 8 (4.5-5.0V)			ns	

For additional information contact:

SCI SYSTEMS
 P.O. BOX 1000 M/S 240
 Huntsville, Alabama 35807

Telephone: (256) 882-4569
 FAX: (256) 882-4652



NOTES:
 1. Dimensions shown are in inches unless otherwise specified.
 2. Lead identification numbers are for reference only.
 3. Lead outline shall be conformed with 0.010 in outline dimensions. Lead spacing dimensions apply only to coating plans.
 4. Pin internal leads solderability requirements of MIL-STD-2032, Method 2080 or MIL-STD-883C.
 5. Package is liquid filled foam.
 6. Quality Assurance Program - Based on ISO 9001.

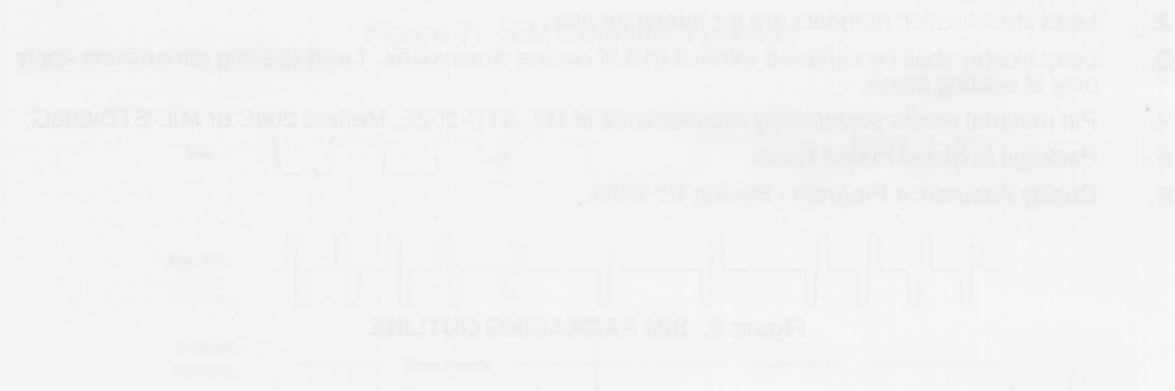

Figure 8. SIM Coupler Channel Select