

**TOSHIBA**

FILE NO. 020-200506

SERVICE MANUAL

# Projection Television

***52HM85***  
***62HM85***

# CIRCUIT BLOCK DIAGRAM

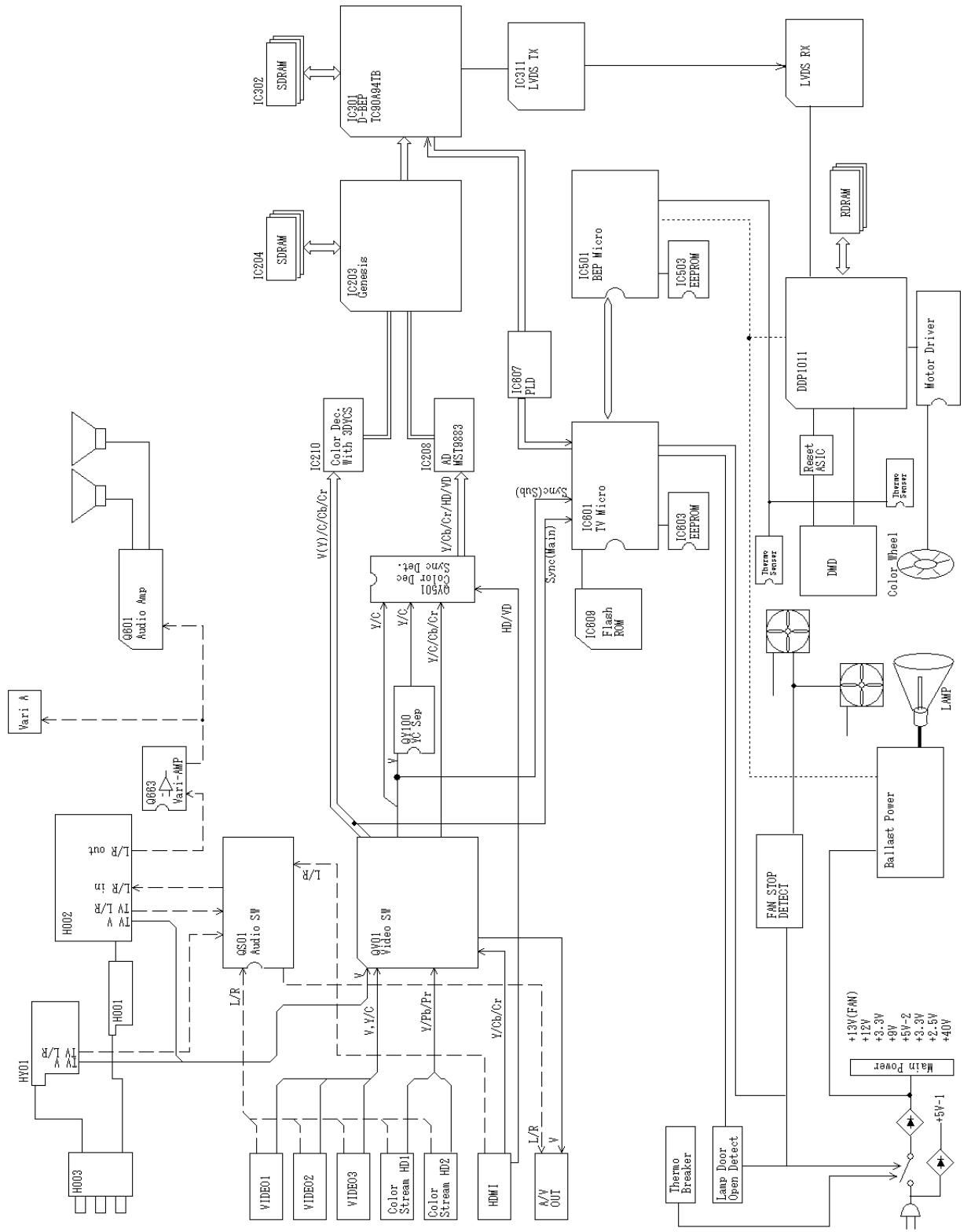

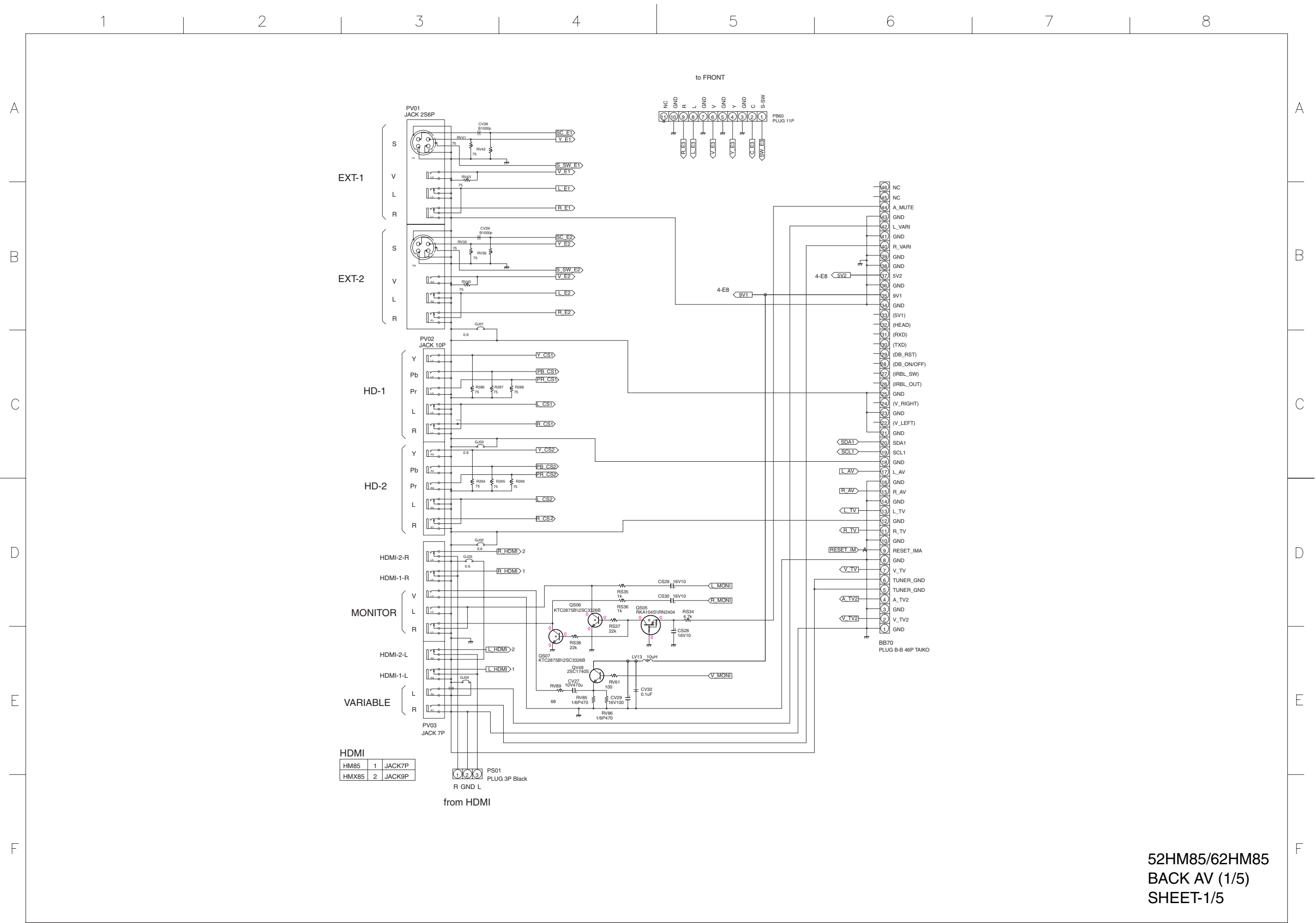

HDMI	
HMB5	1 JACK7P
HMX85	2 JACK9P

from HDMI  
 PS01 PLUG 3P Black  
 R GND L

52HM85/62HM85  
 BACK AV (1/5)  
 SHEET-1/5

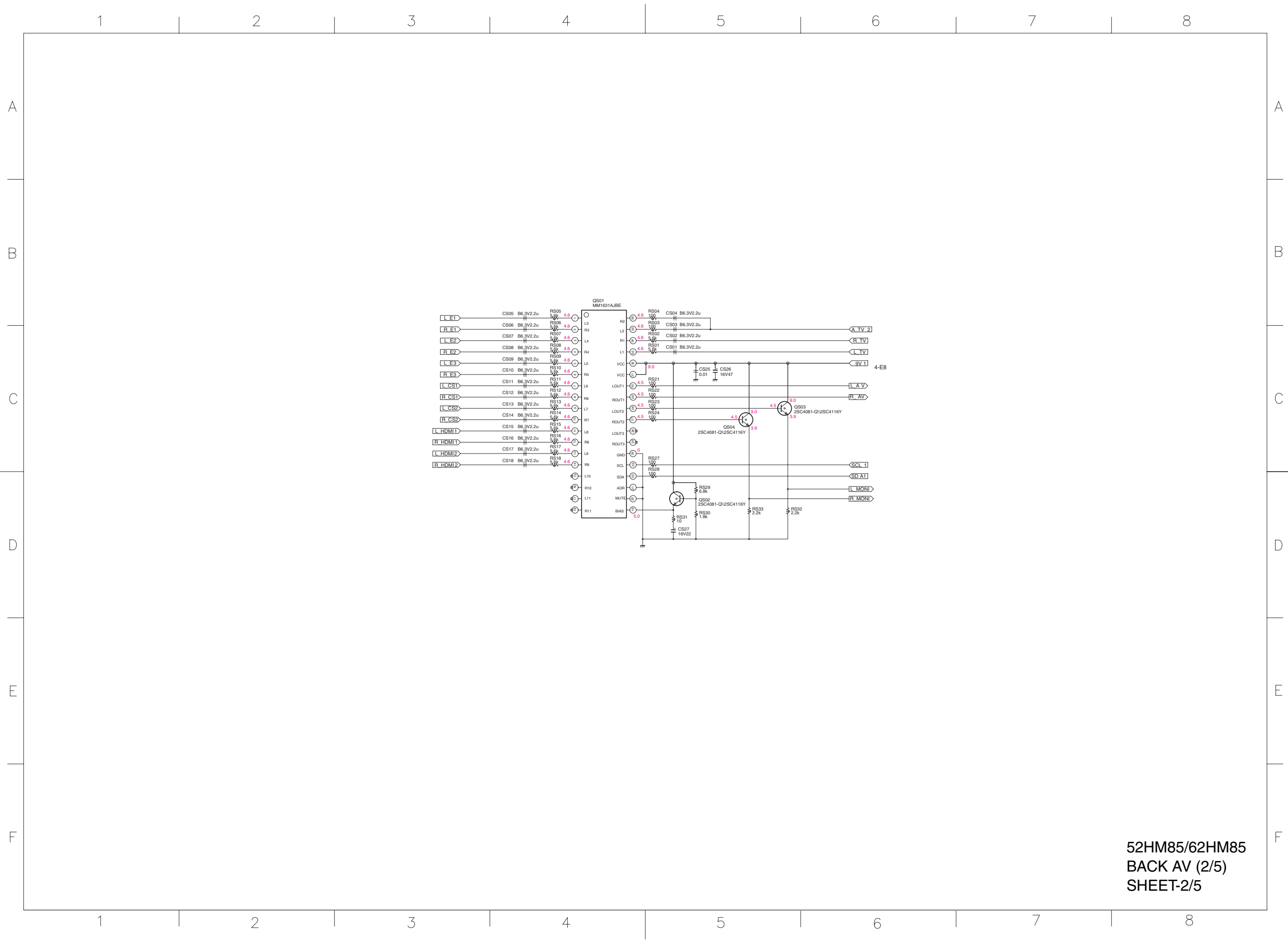

52HM85/62HM85  
 BACK AV (2/5)  
 SHEET-2/5

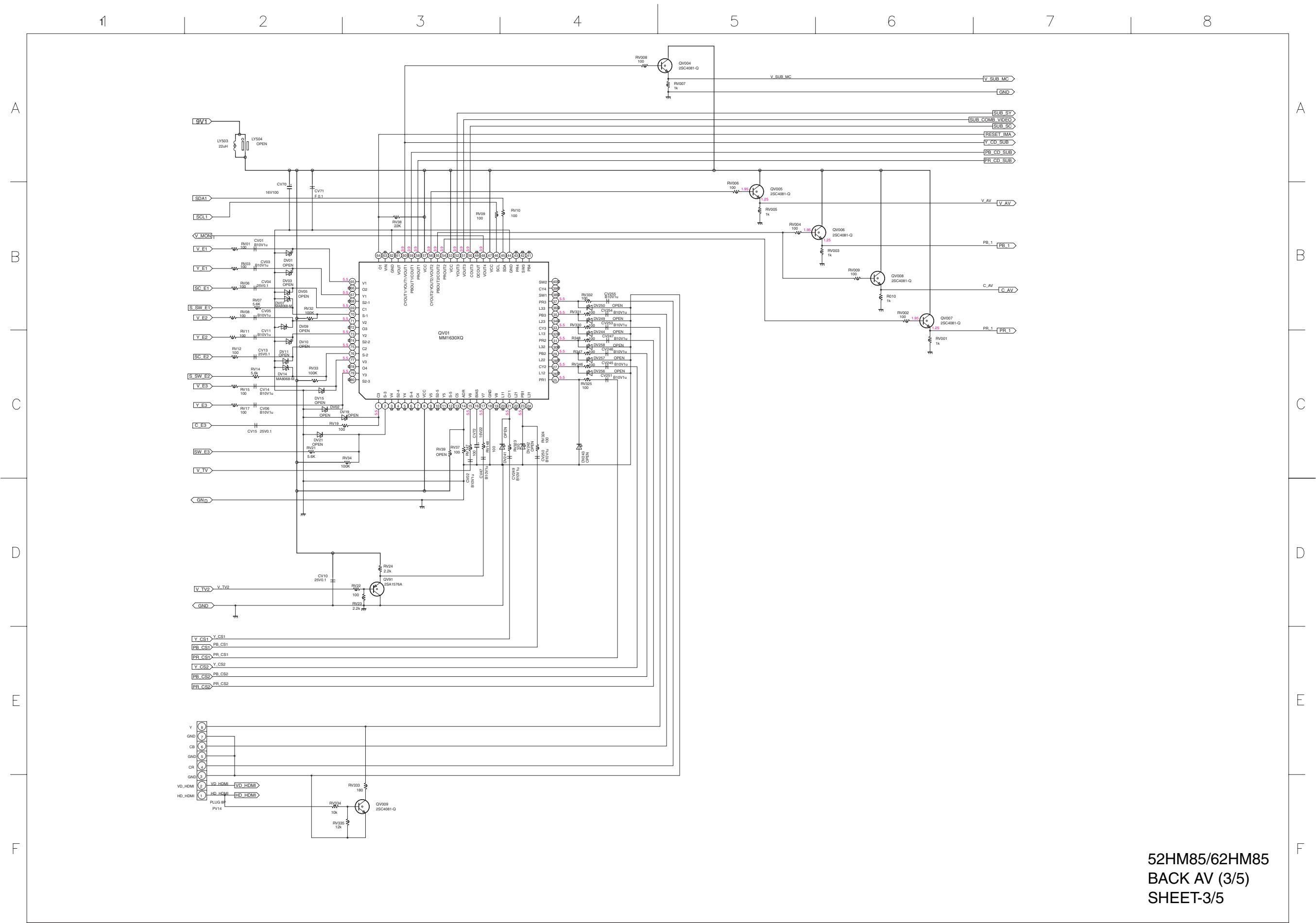

52HM85/62HM85  
 BACK AV (3/5)  
 SHEET-3/5

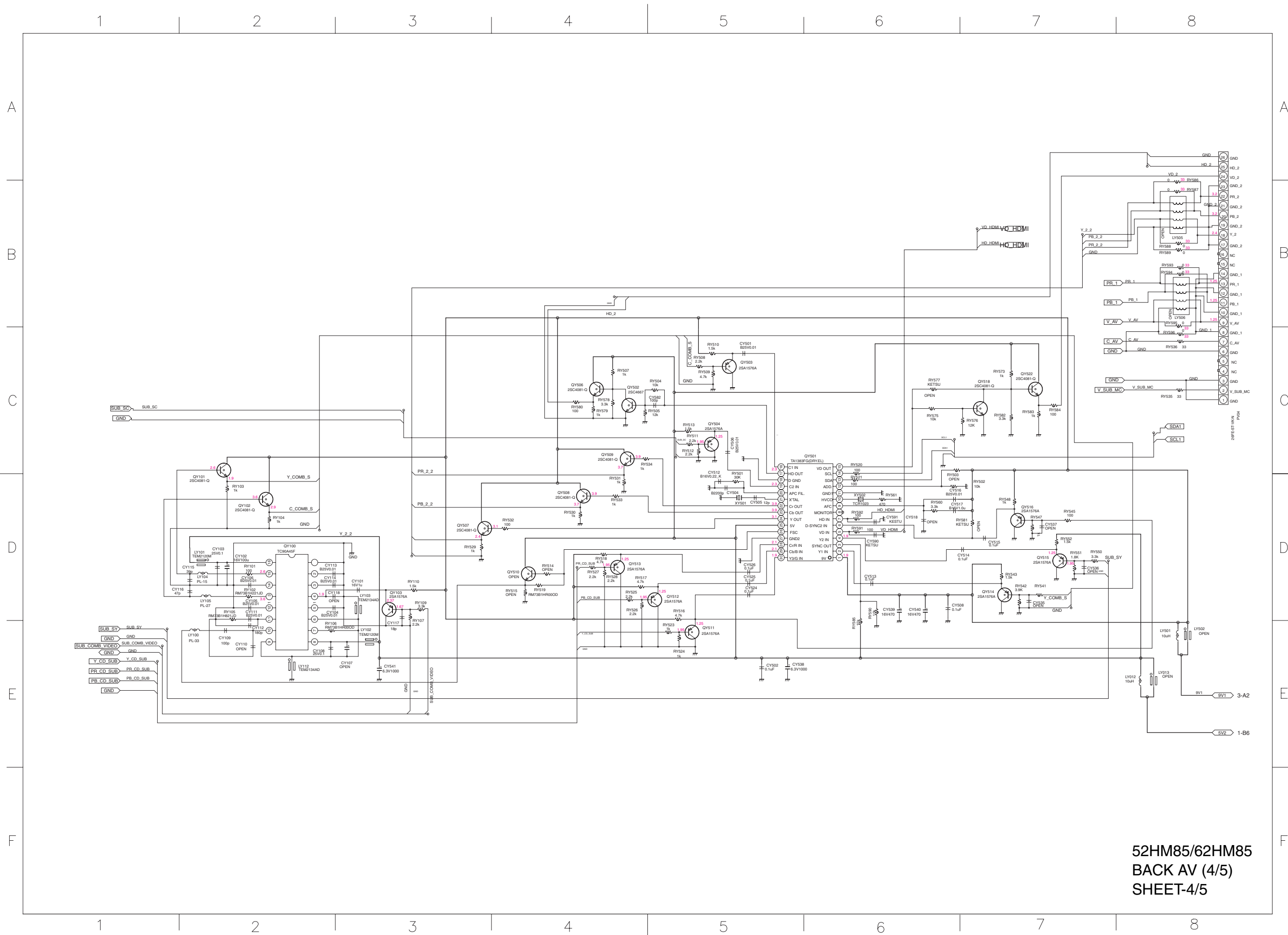

52HM85/62HM85  
BACK AV (4/5)  
SHEET-4/5

1

2

A

A

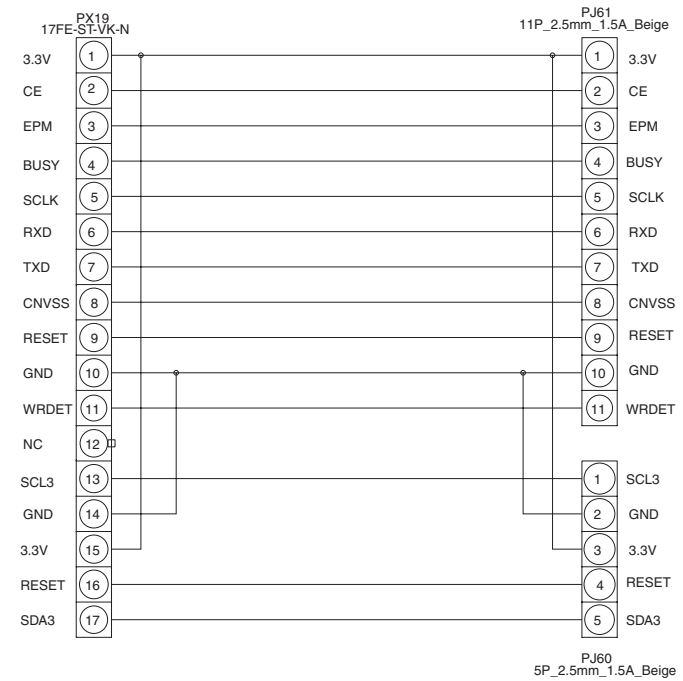
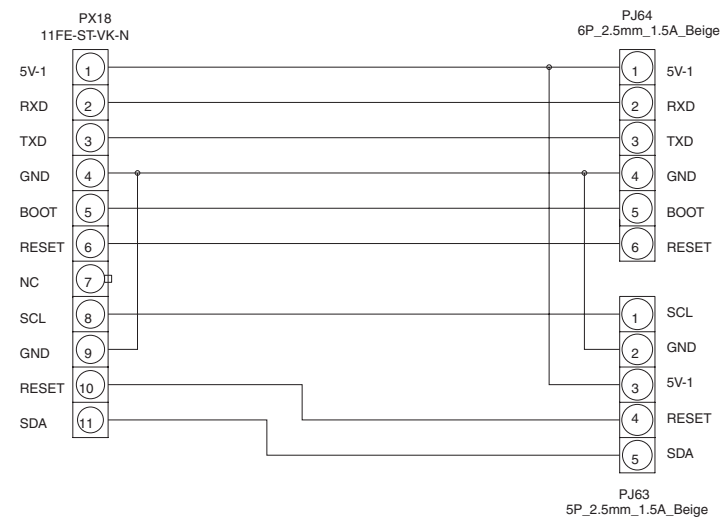

B

B

1

2

52HM85/62HM85  
 BACK AV (5/5)  
 SHEET-5/5

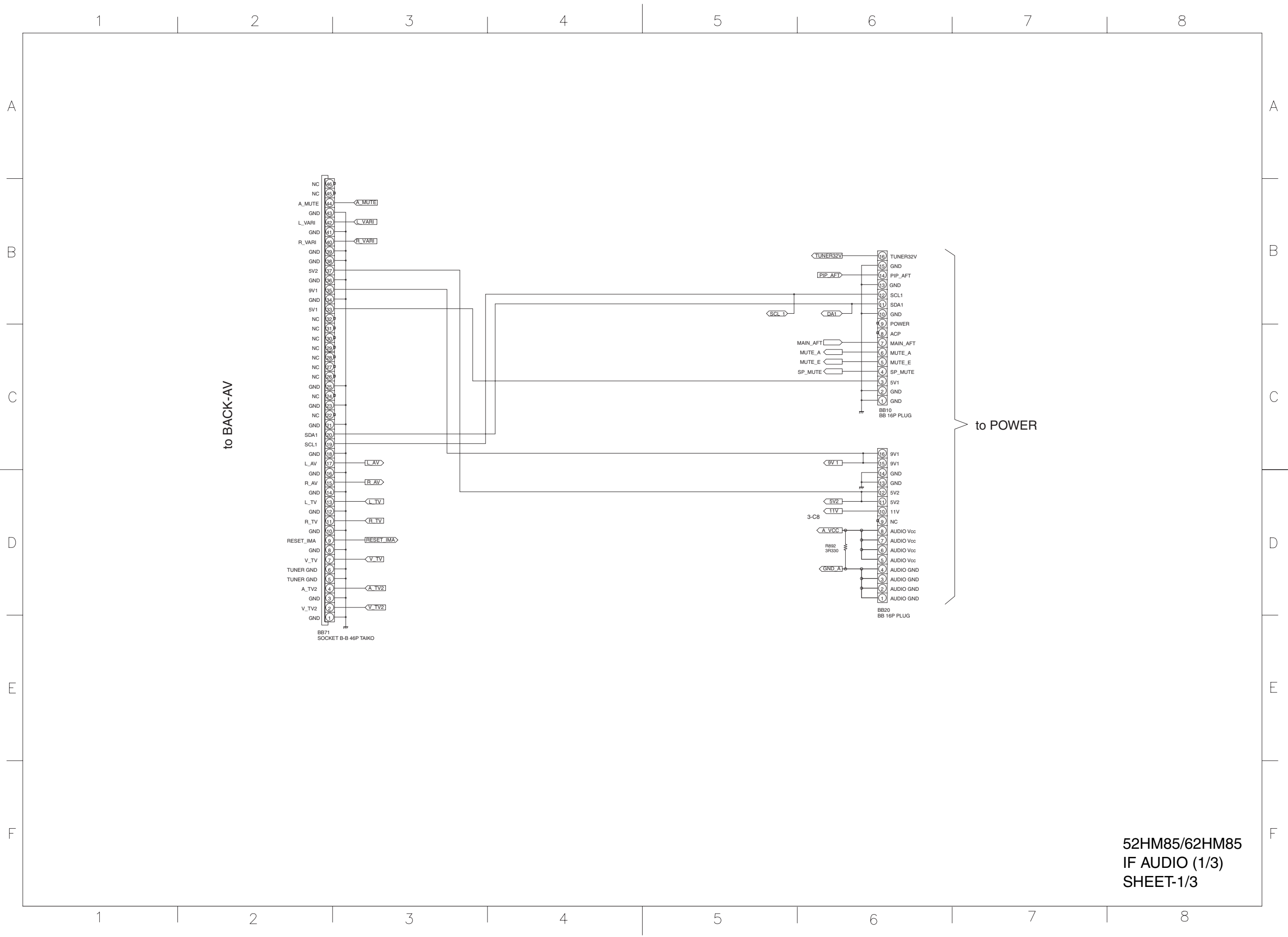

52HM85/62HM85  
IF AUDIO (1/3)  
SHEET-1/3



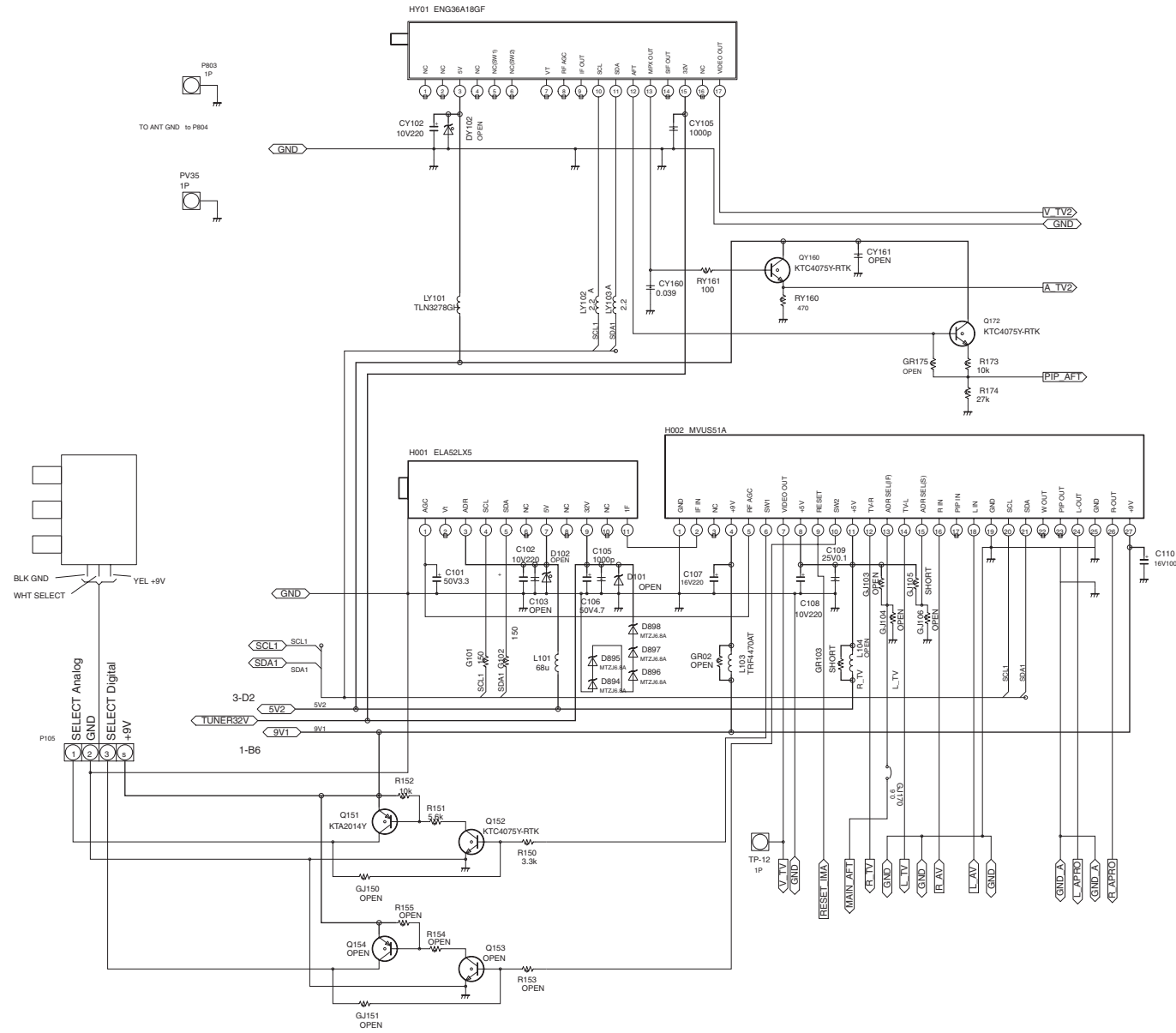

52HM85/62HM85  
 IF AUDIO (2/3)  
 SHEET-2/3

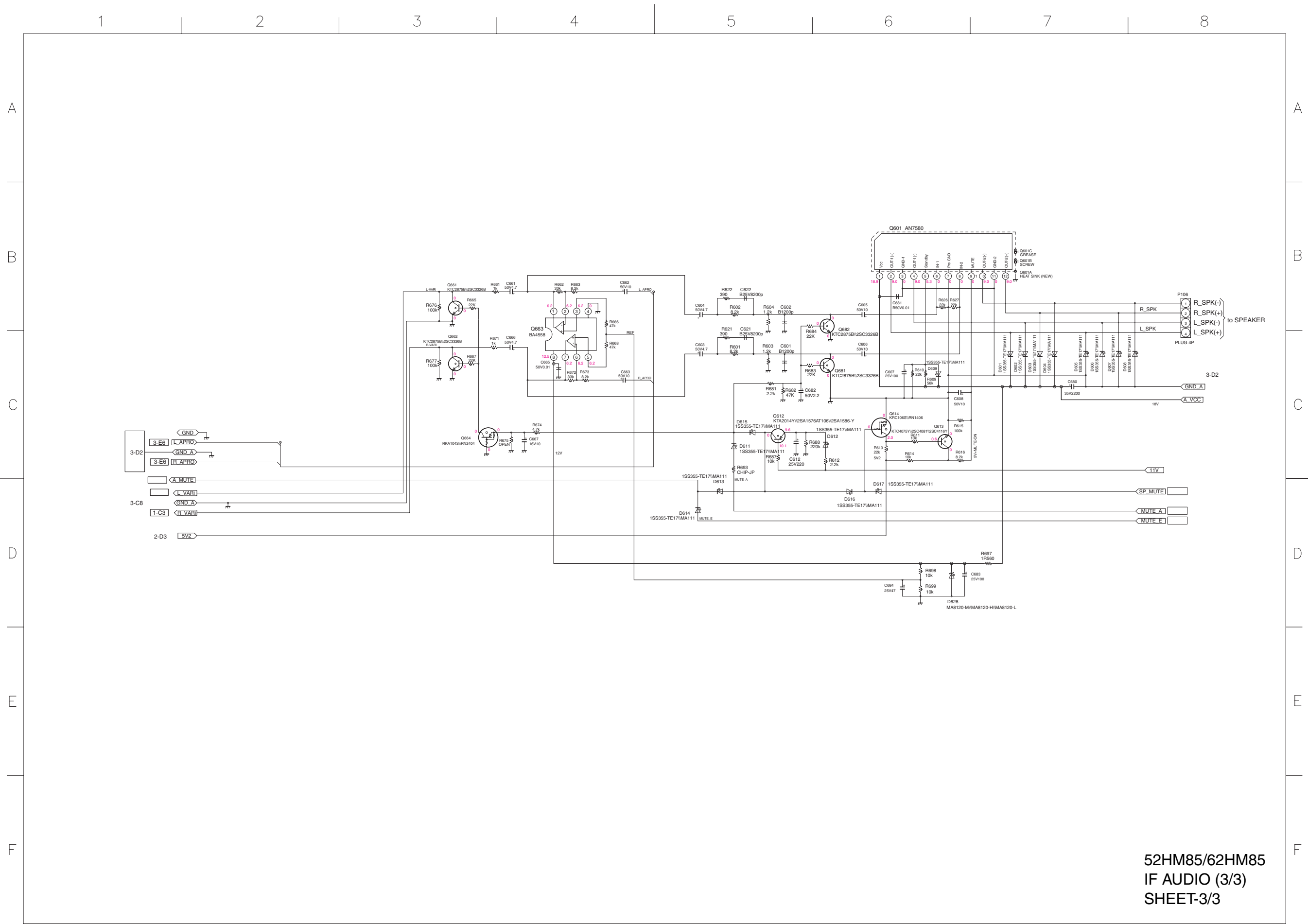

52HM85/62HM85  
IF AUDIO (3/3)  
SHEET-3/3

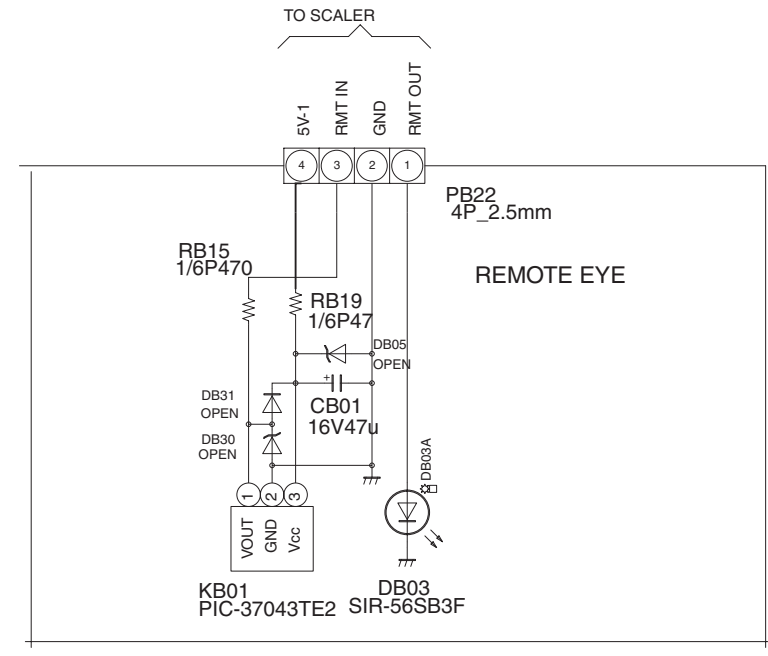
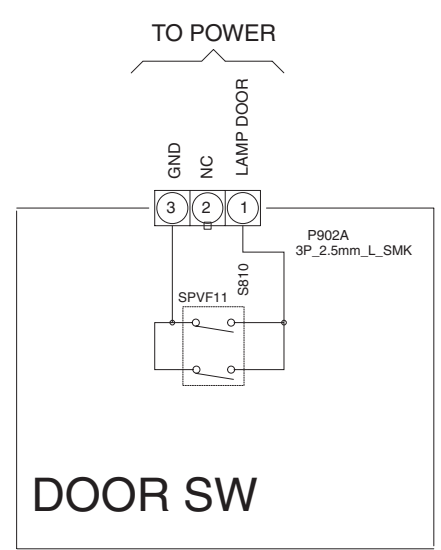
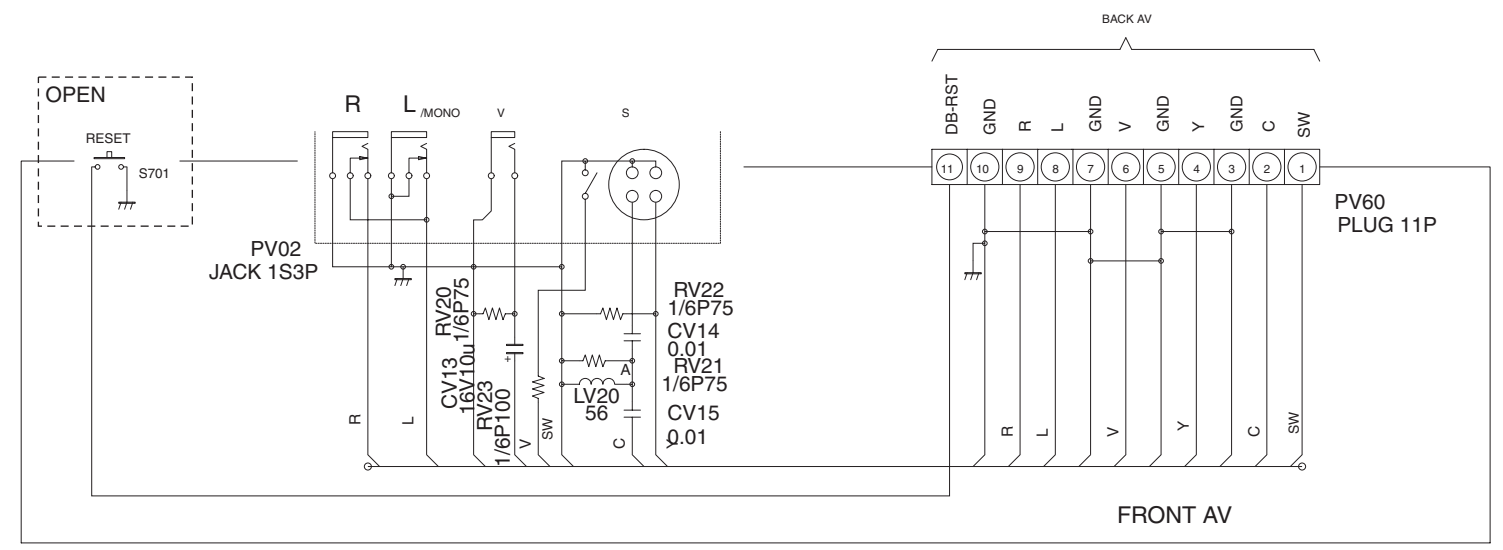

52HM85/62HM85  
F-AV

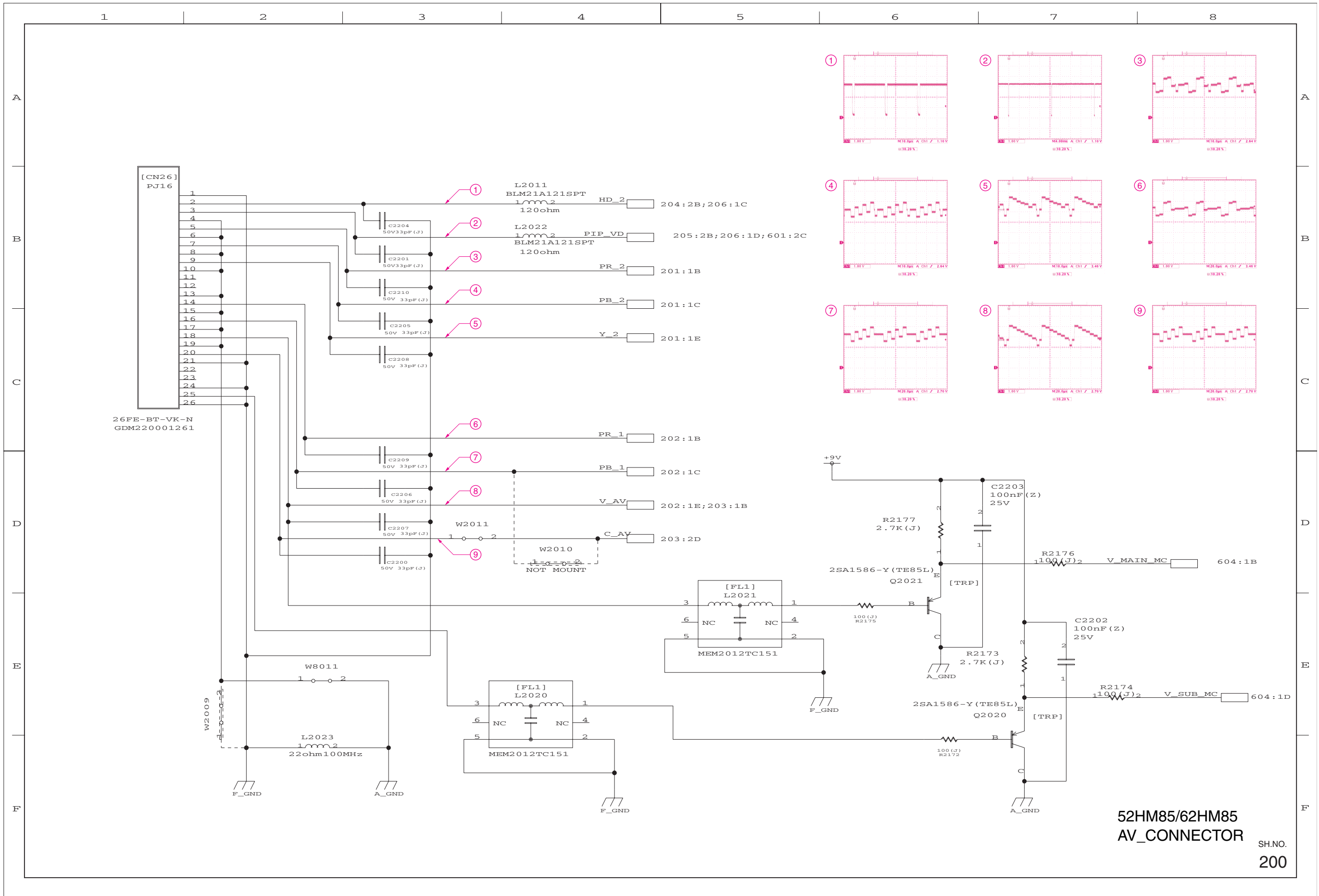

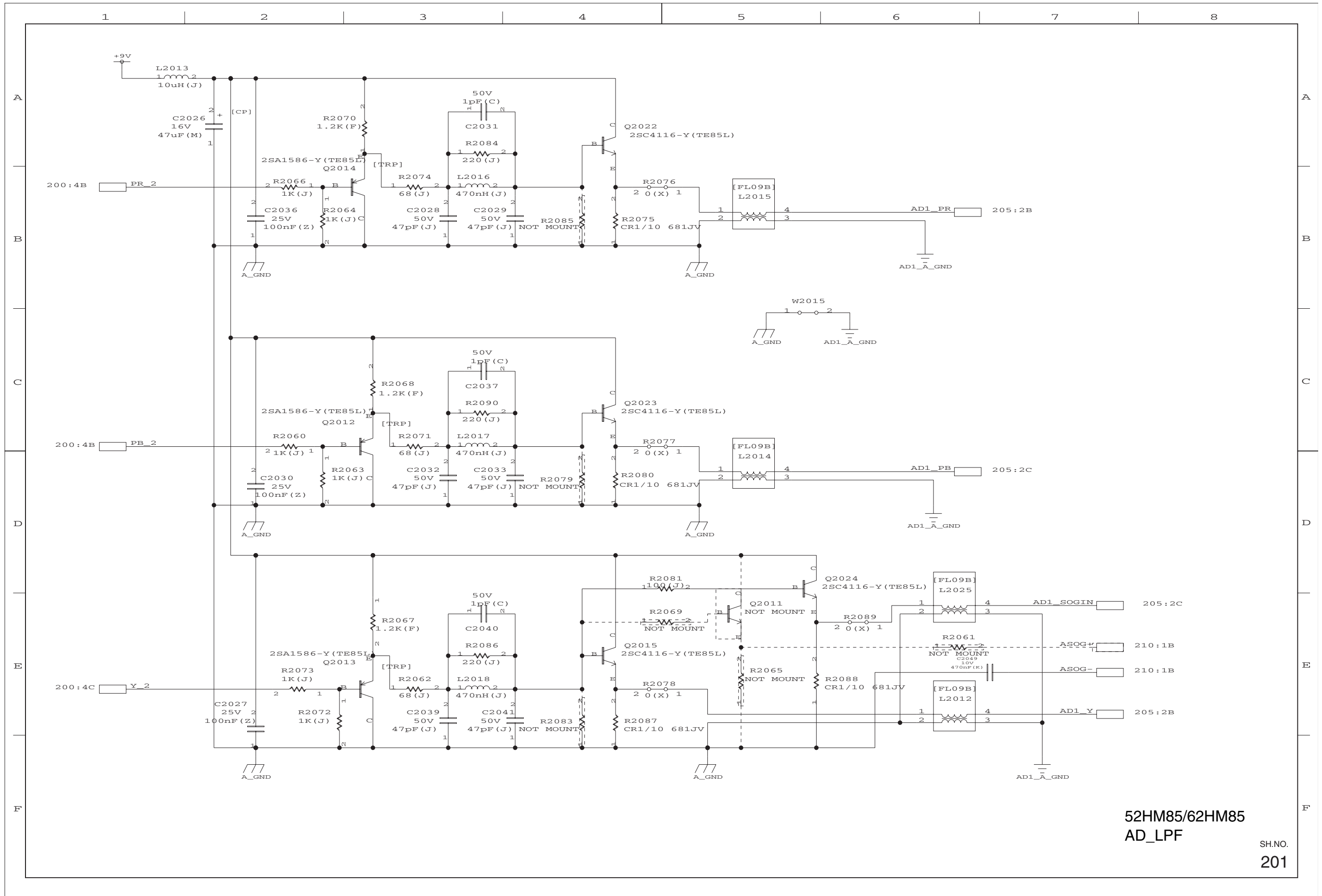

52HM85/62HM85  
AD\_LPF

SH.NO.  
201

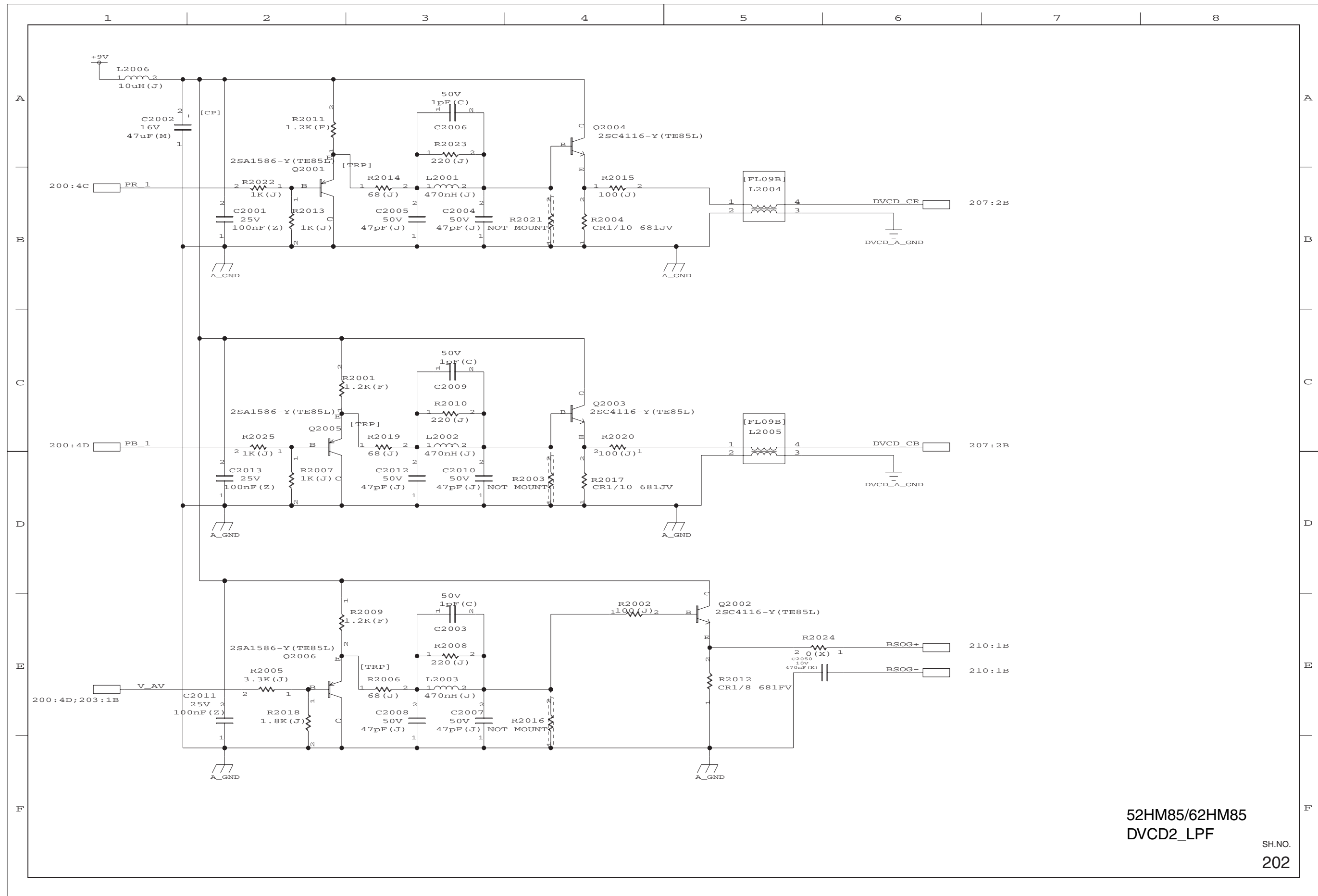

52HM85/62HM85  
DVCD2\_LPF

SH.NO.  
202

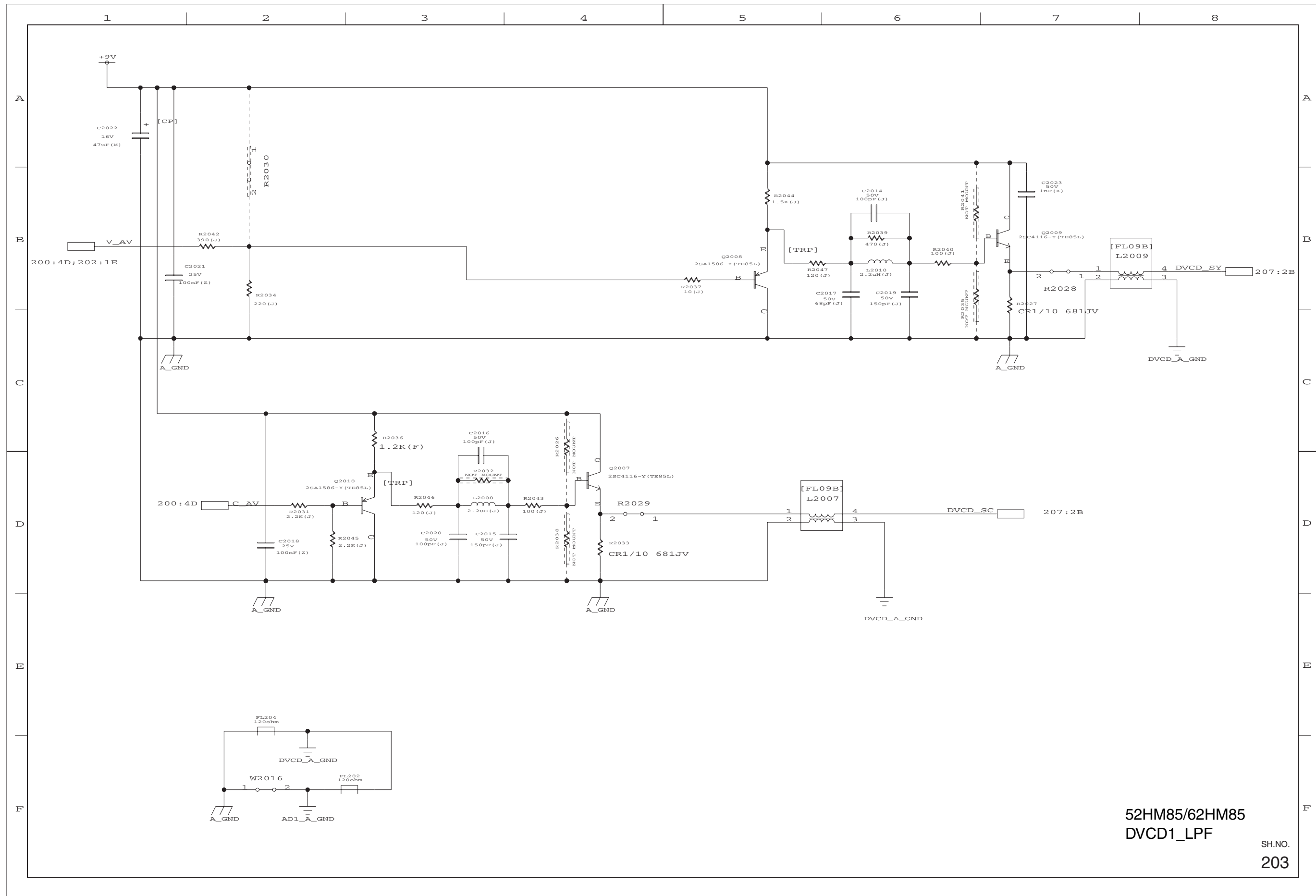

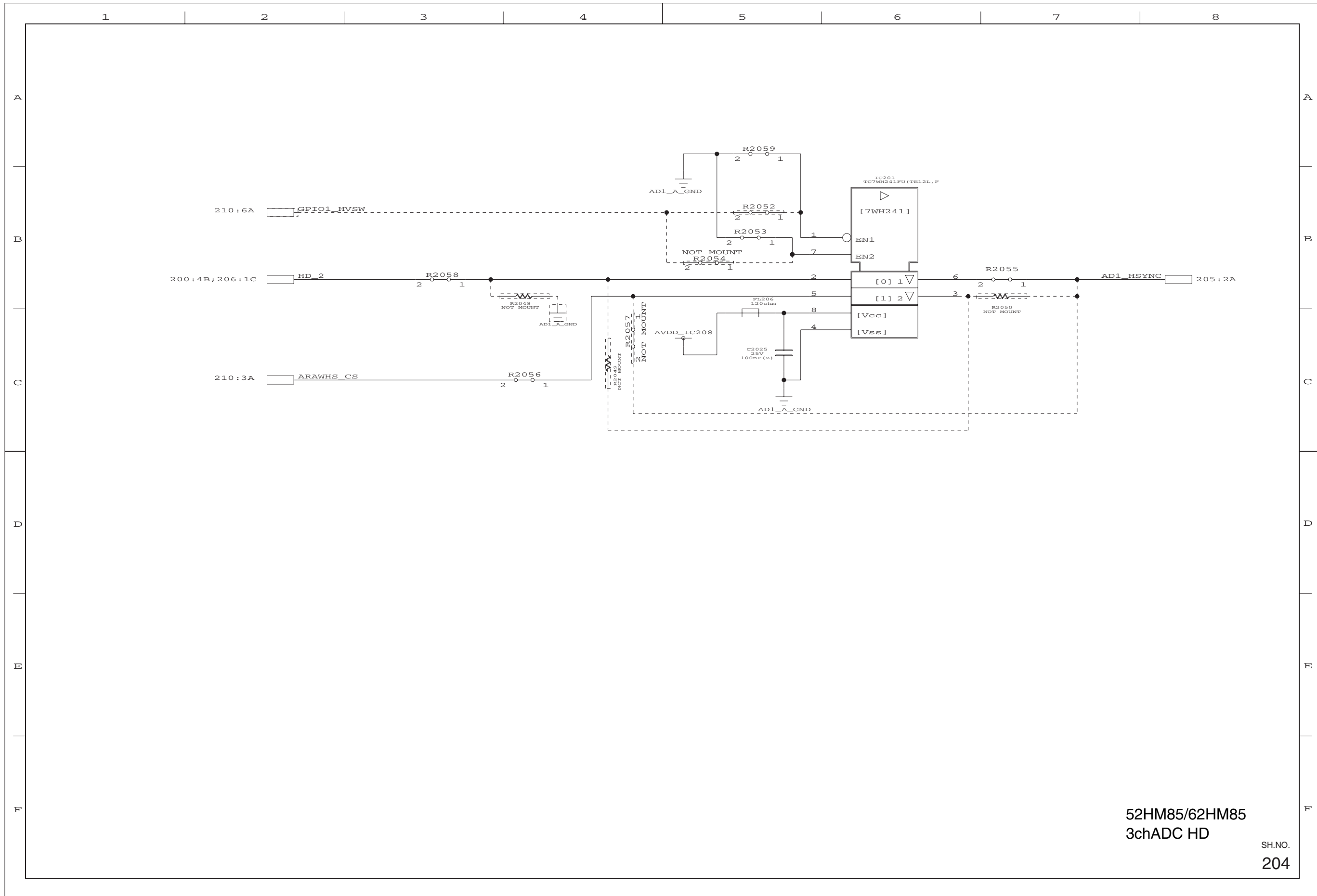



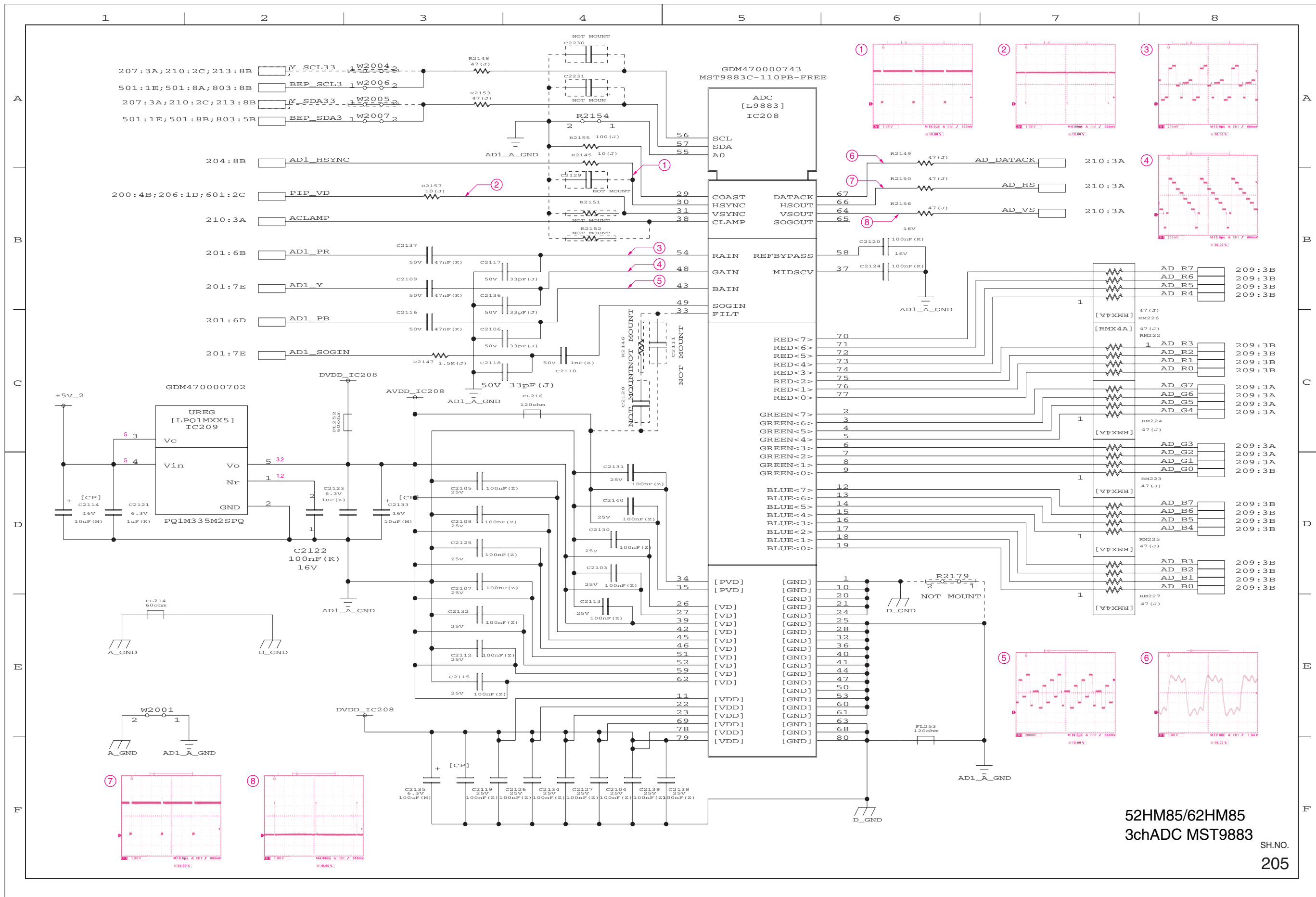

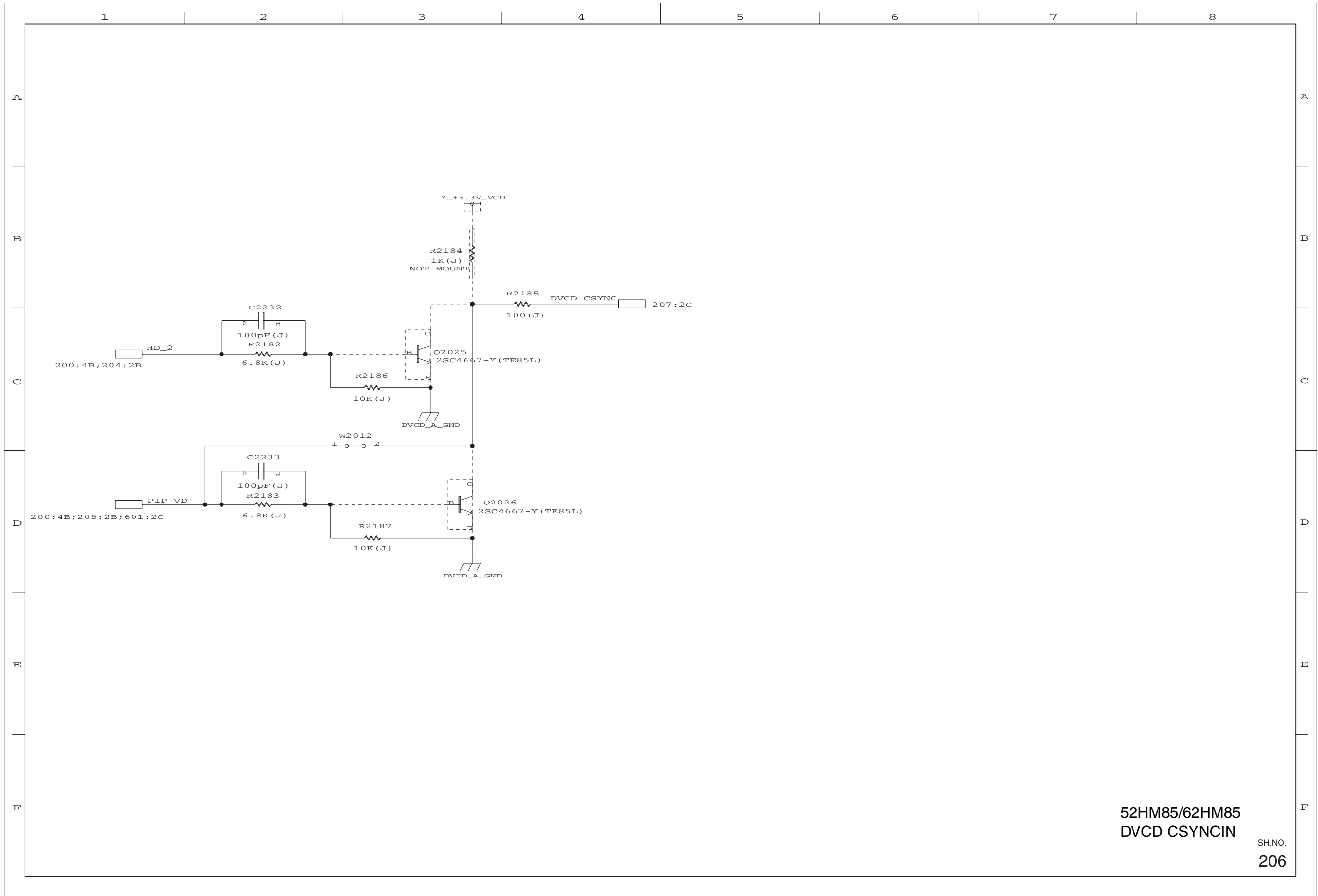

52HM85/62HM85  
DVCD CSYNCIN

SH.NO.  
206

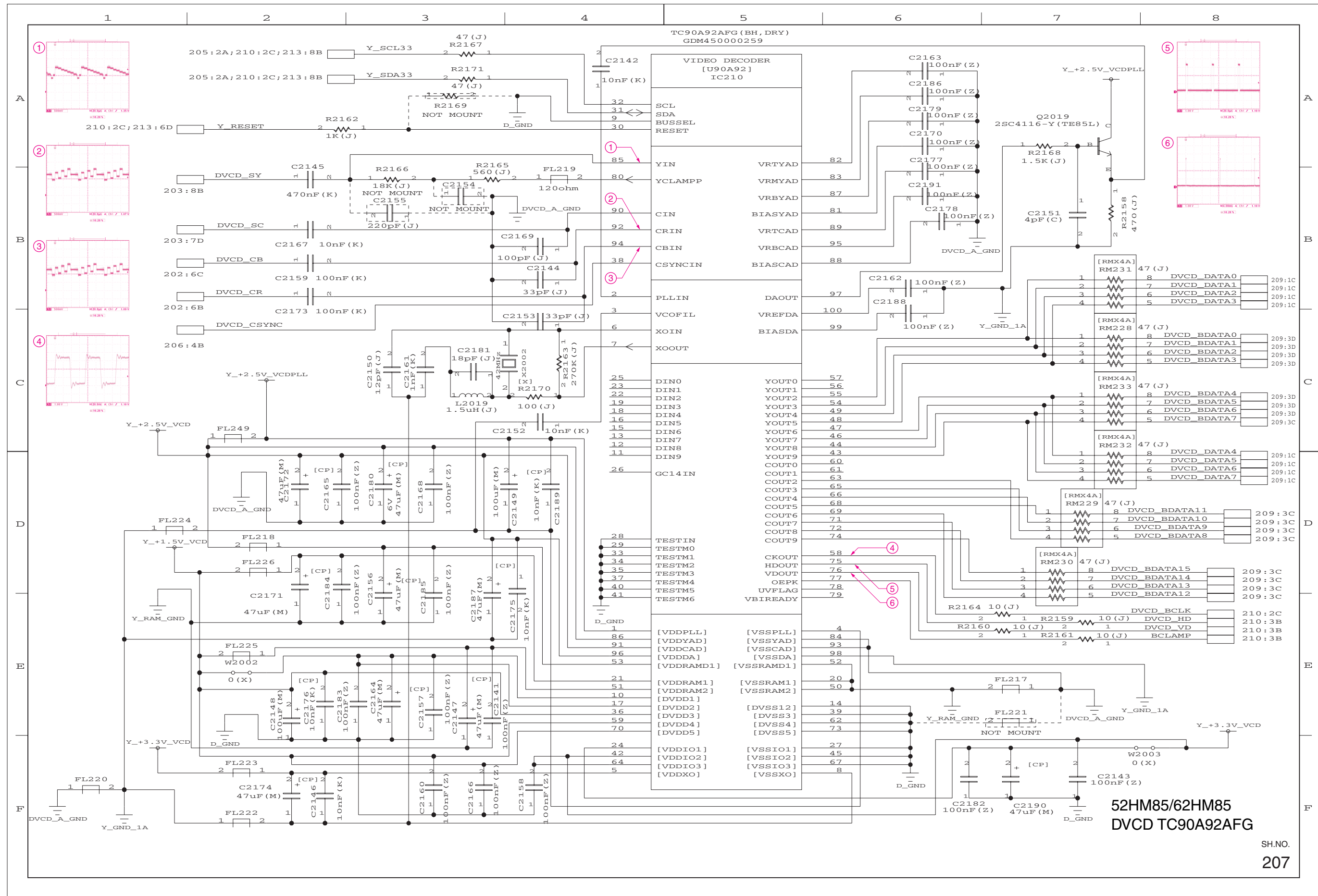

52HM85/62HM85  
DVCD TC90A92AFG

SH.NO.  
207

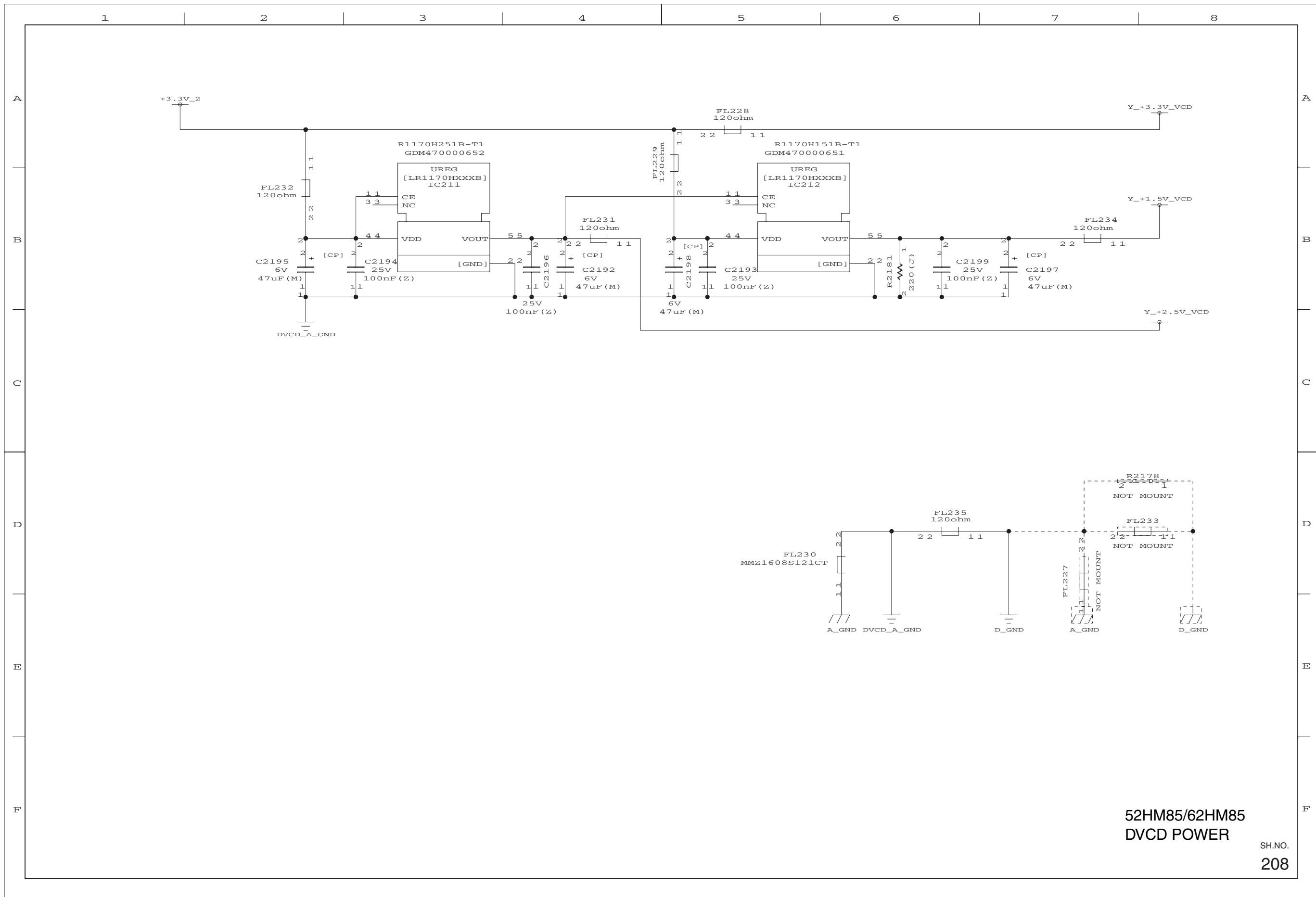

52HM85/62HM85  
DVCD POWER

SH.NO.  
208

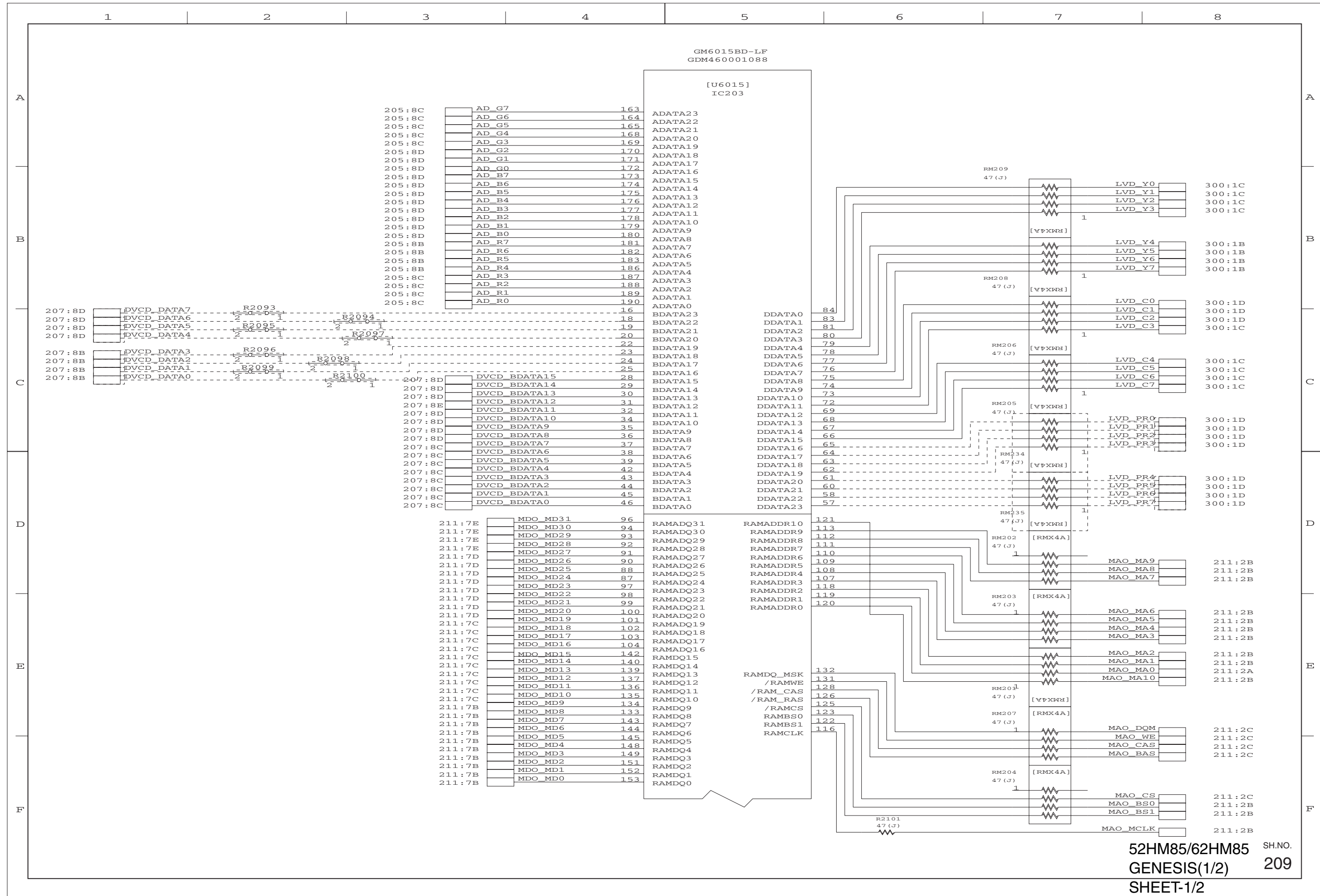

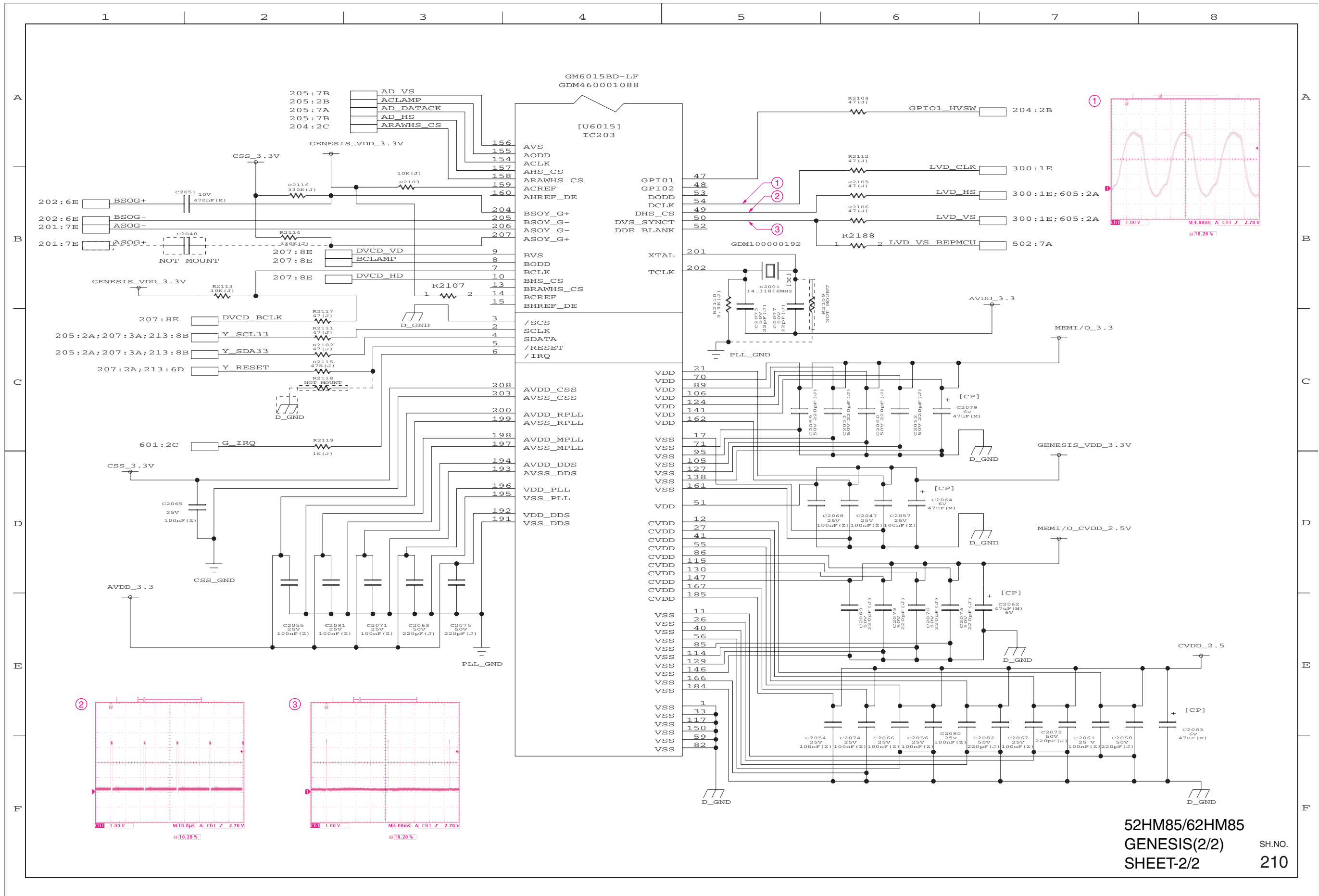

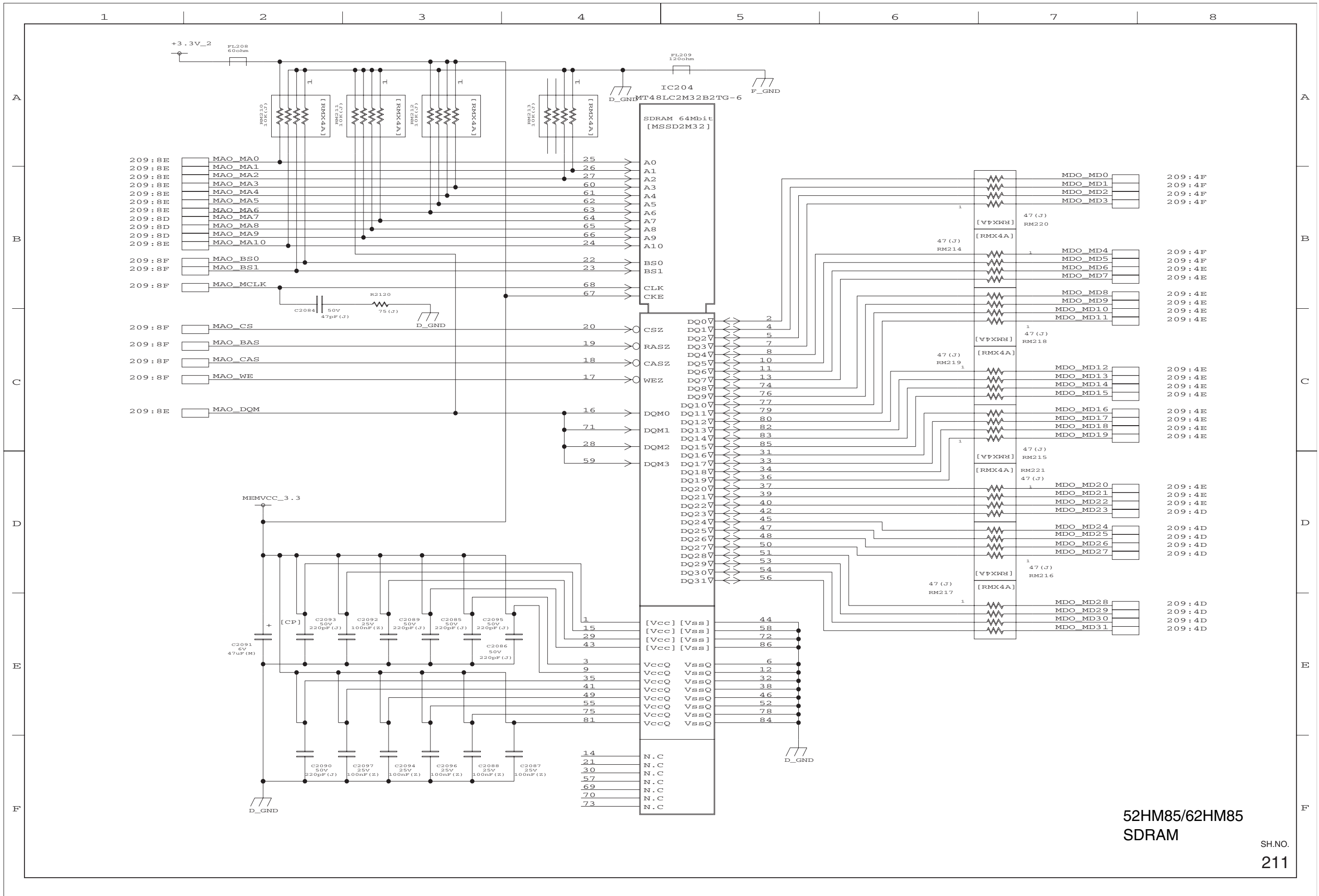

52HM85/62HM85  
SDRAM  
SH.NO.  
211

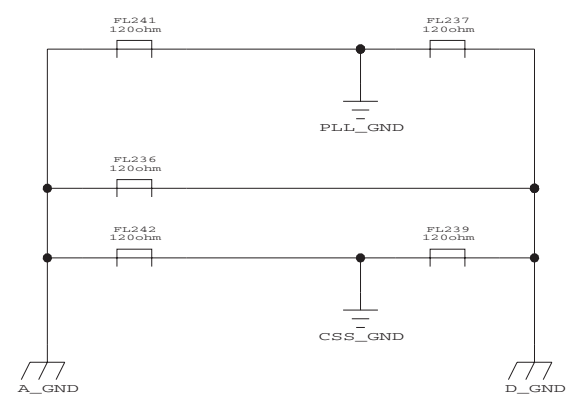
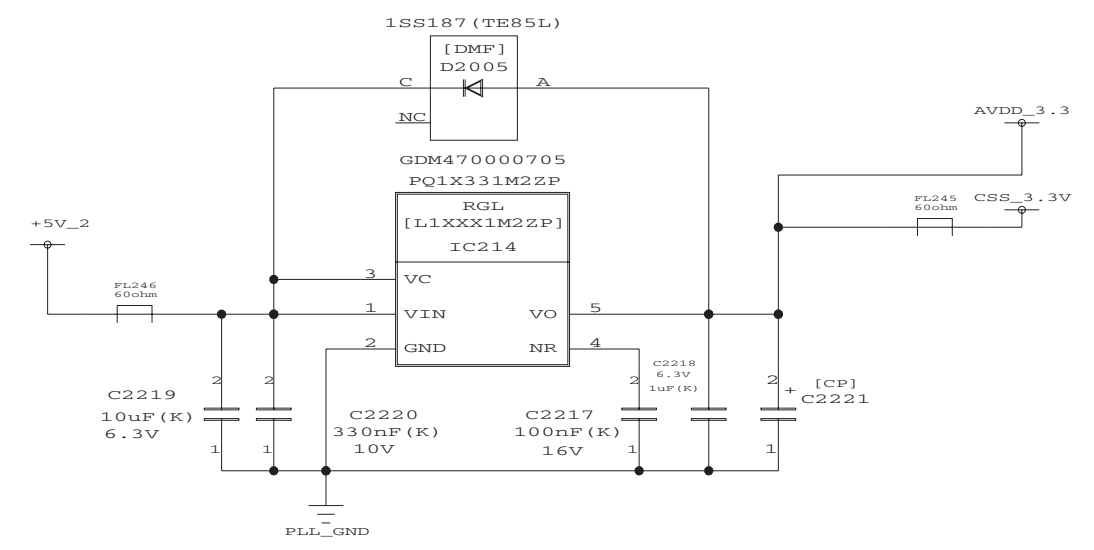
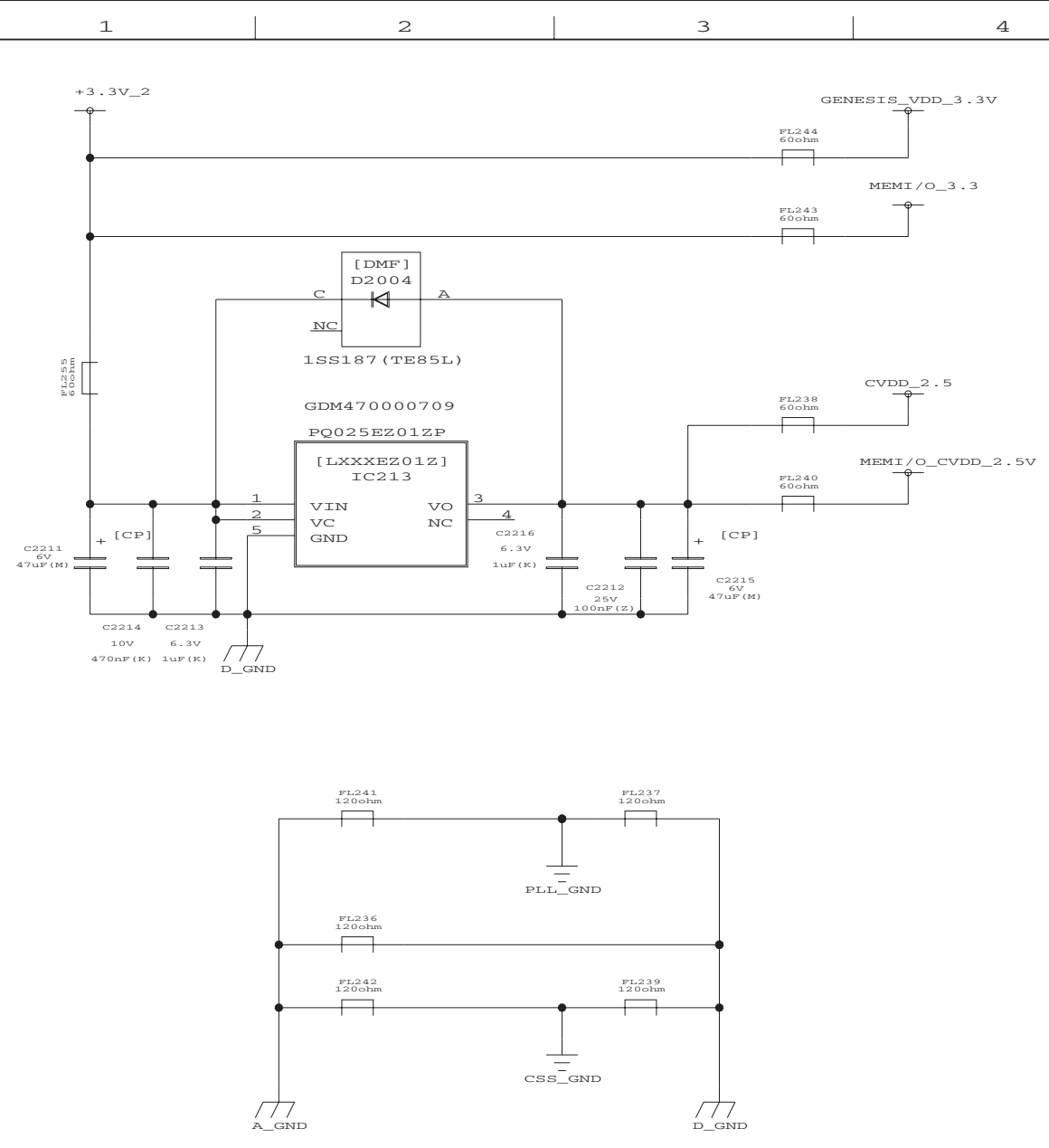

52HM85/62HM85  
 GENESIS\_POWER  
 SH.NO.  
 212



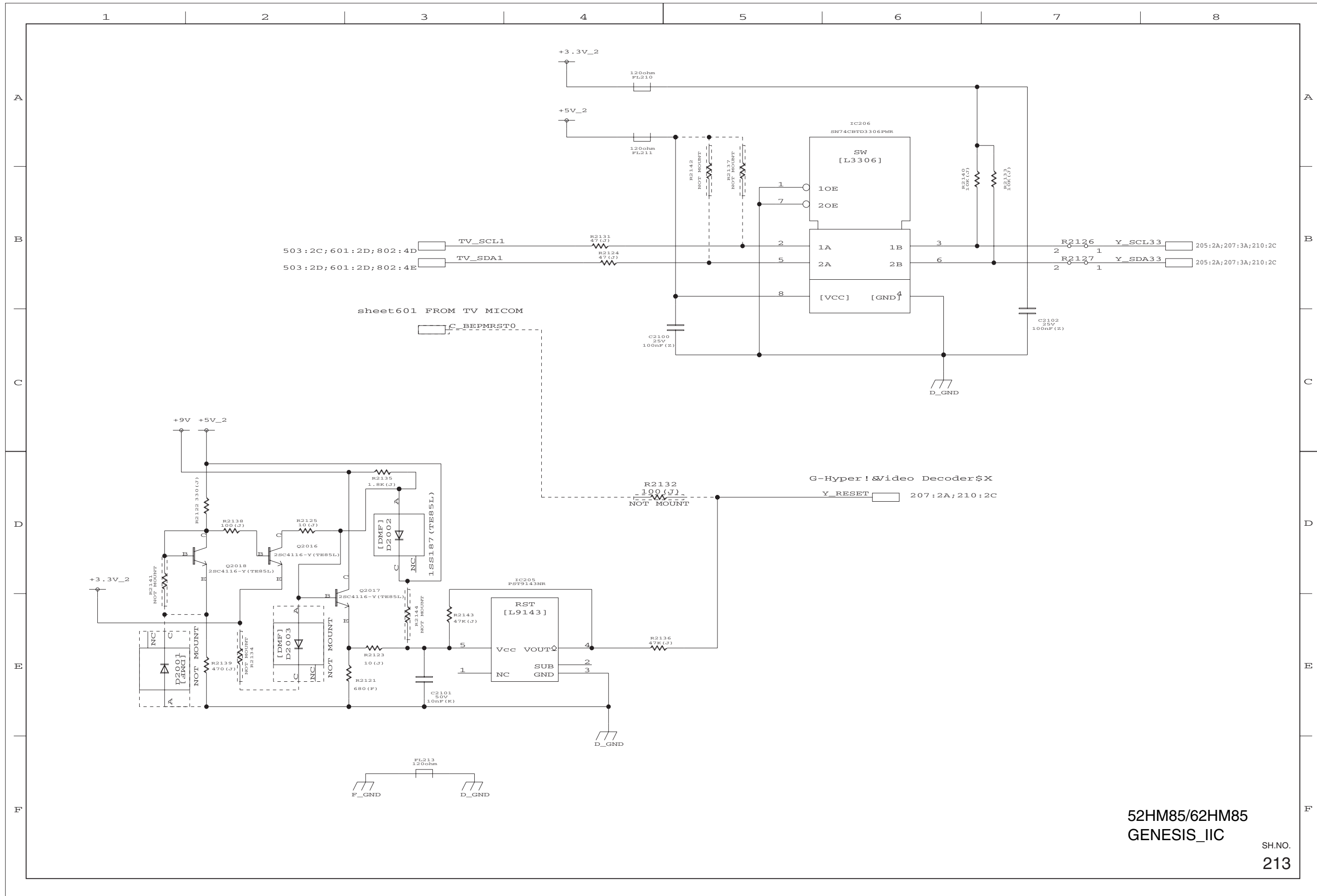

52HM85/62HM85  
GENESIS\_IIC

SH.NO.  
213

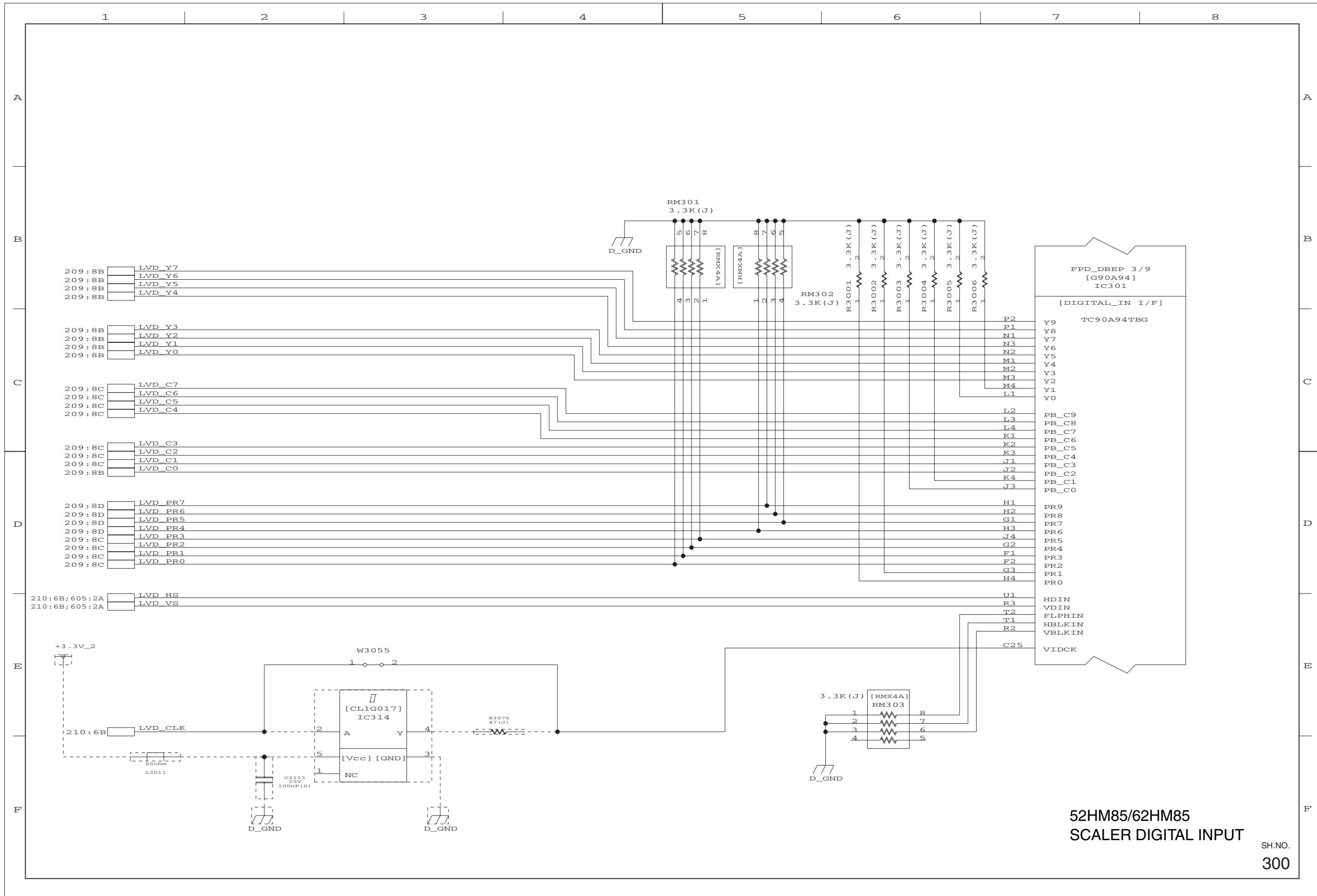

52HM85/62HM85  
SCALER DIGITAL INPUT

SH.NO.  
300

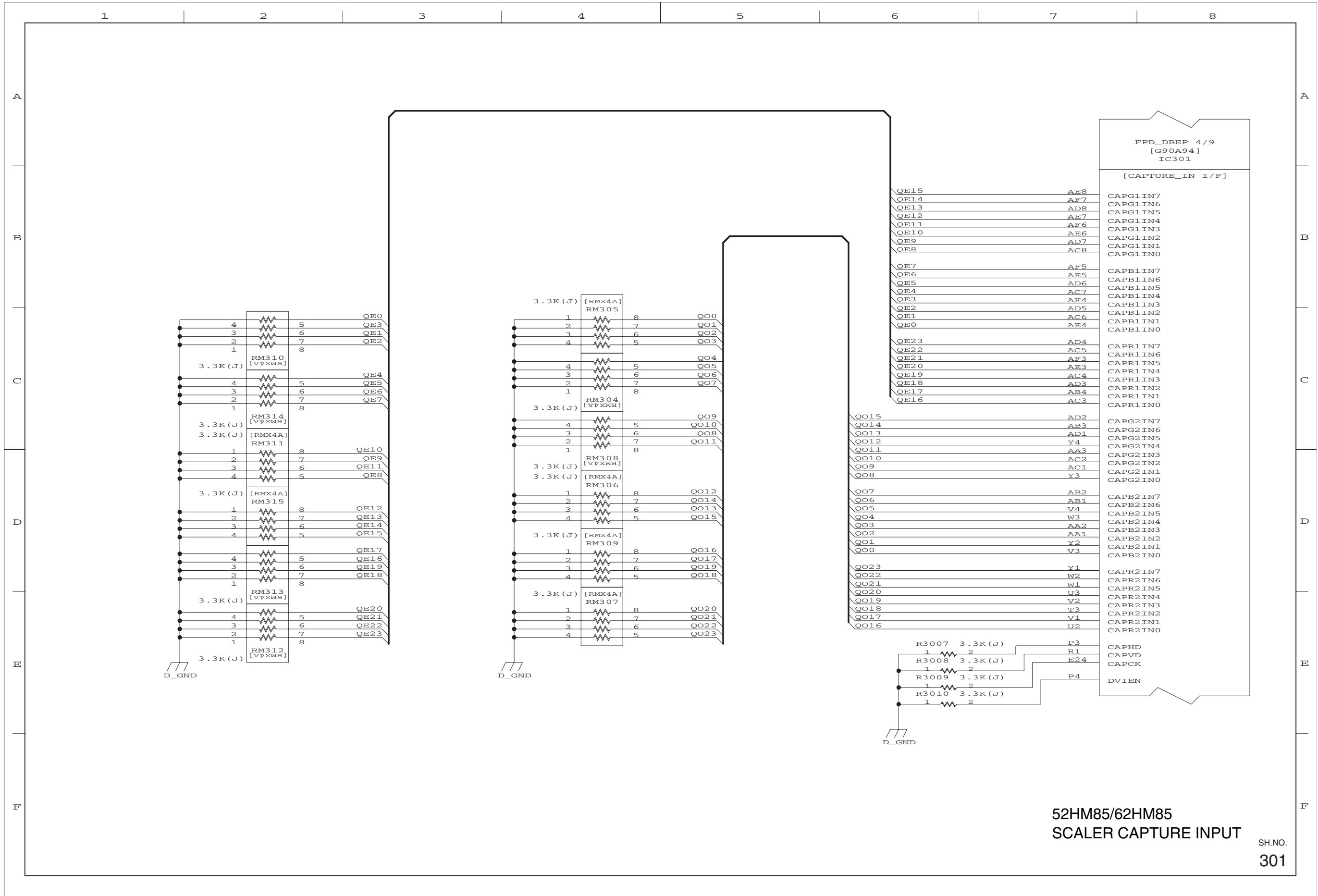

**52HM85/62HM85  
SCALER CAPTURE INPUT**

SH.NO.  
**301**

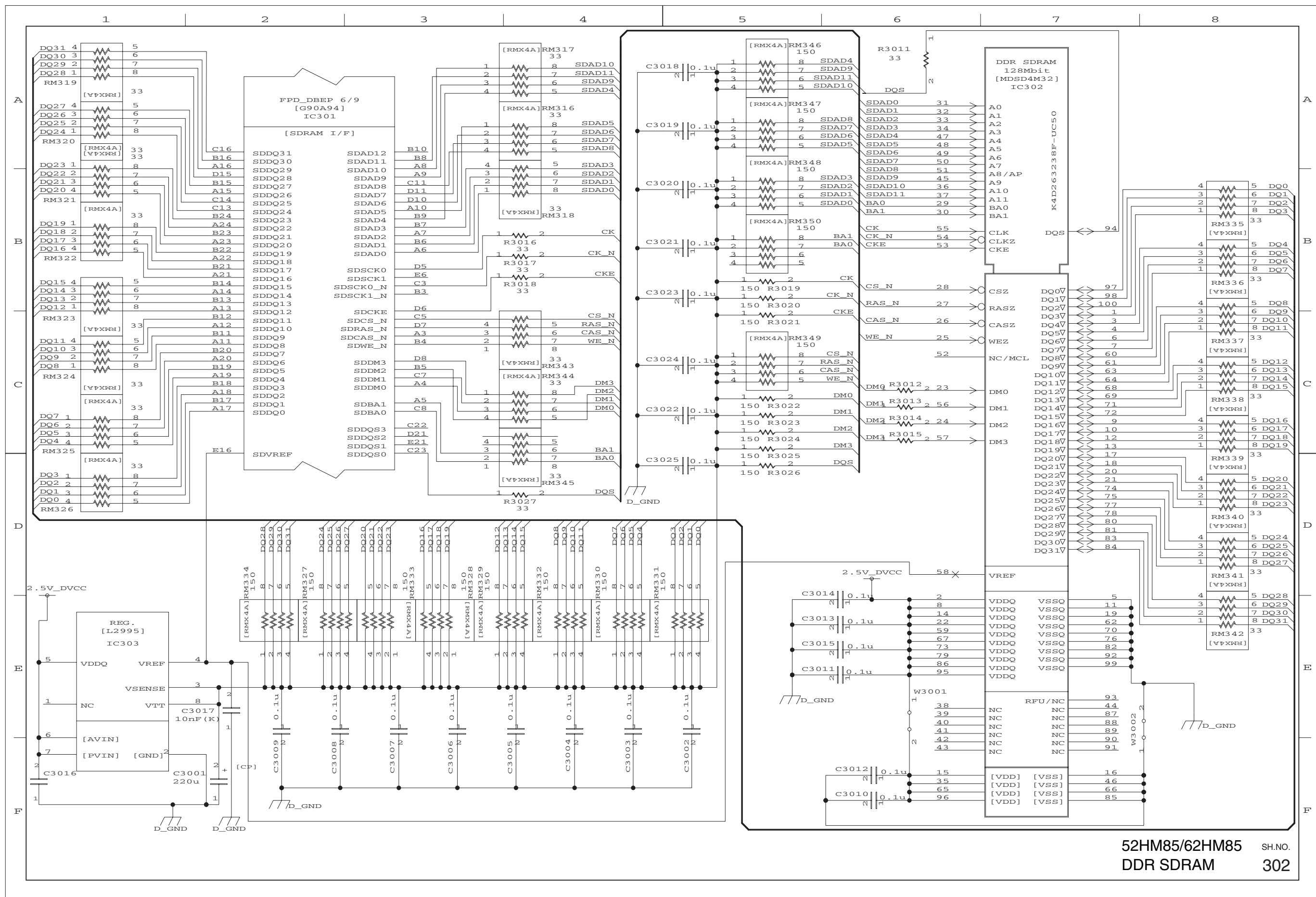

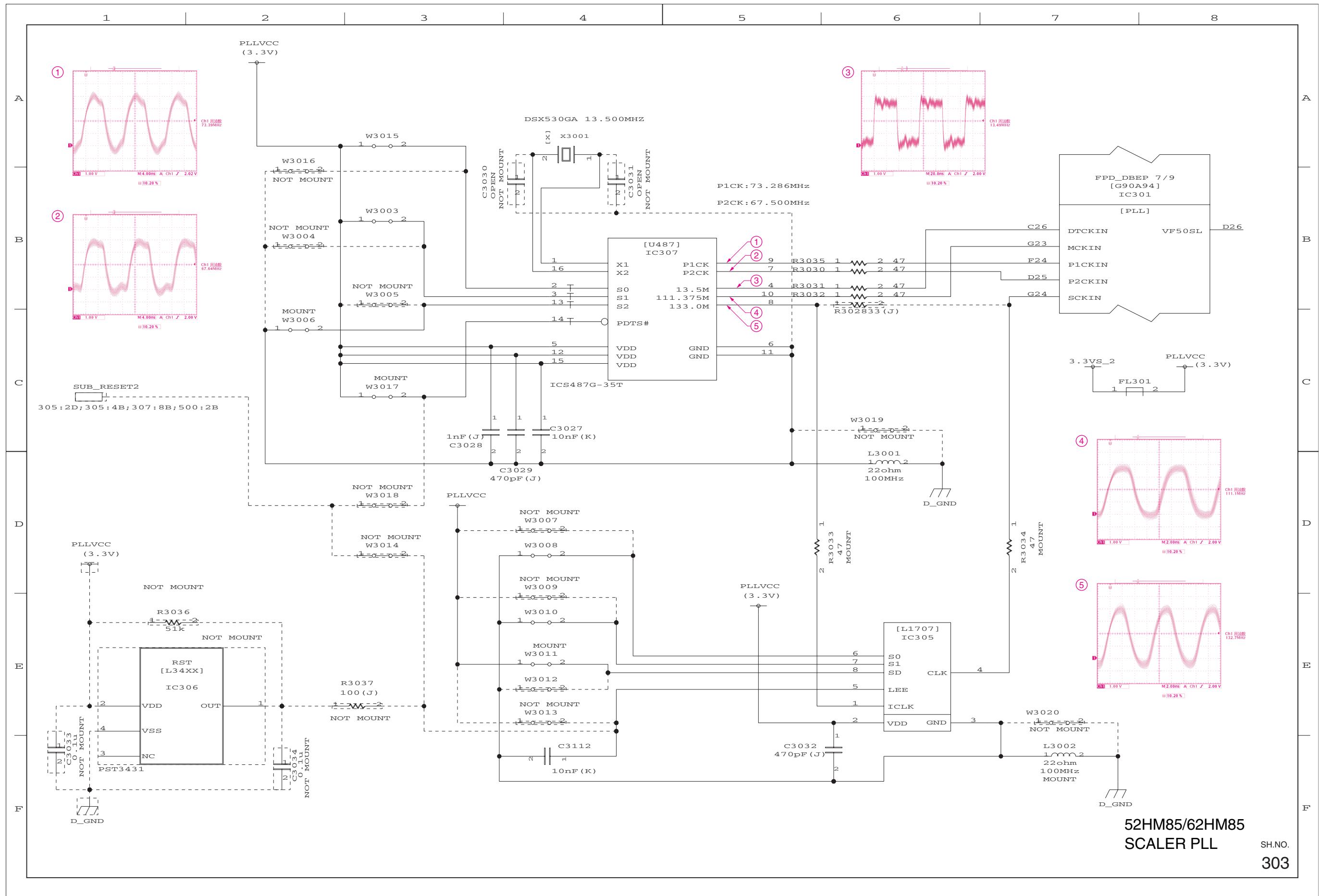

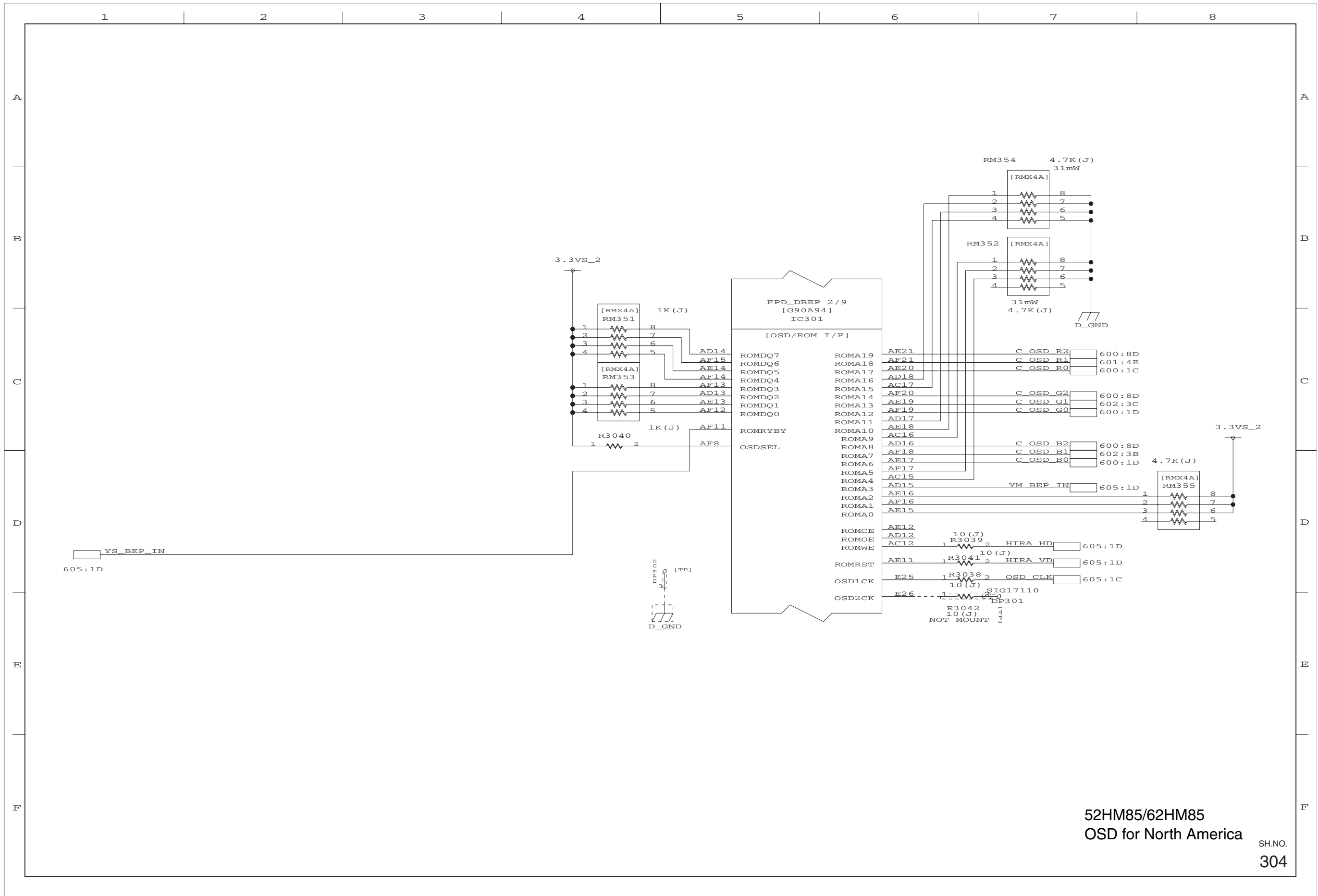

52HM85/62HM85  
 OSD for North America  
 SH.NO.  
 304

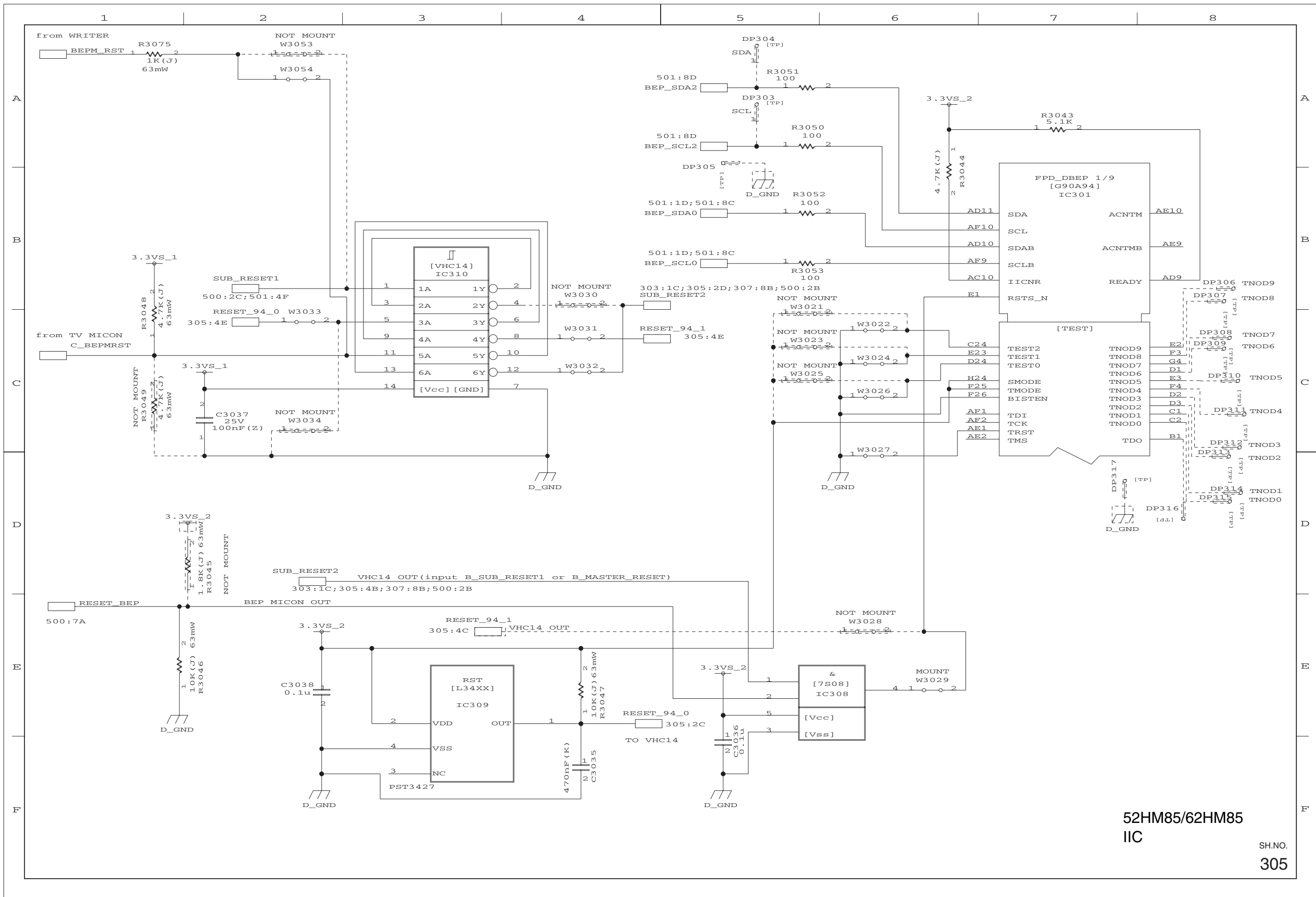

52HM85/62HM85  
IIC  
SH.NO.  
305

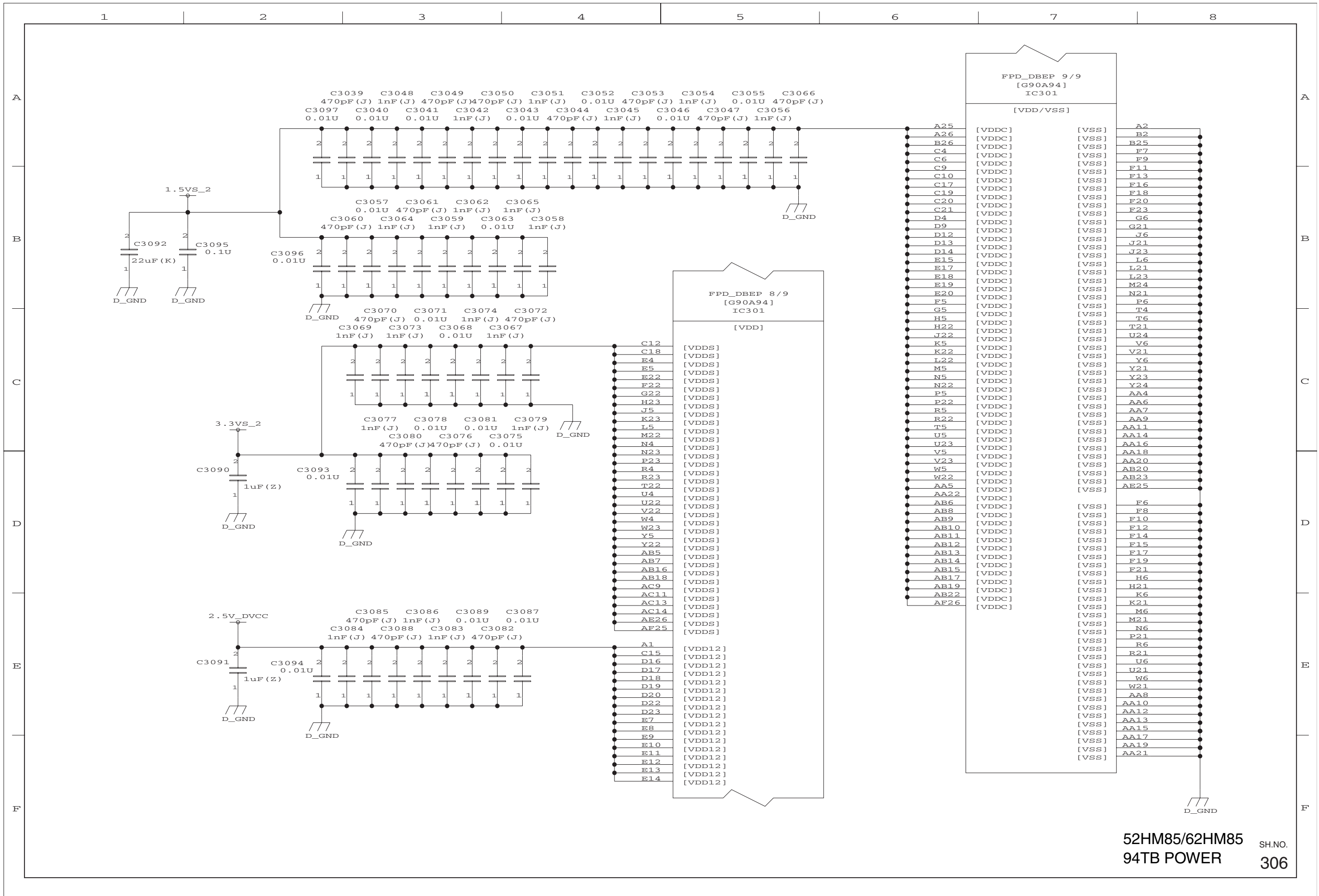



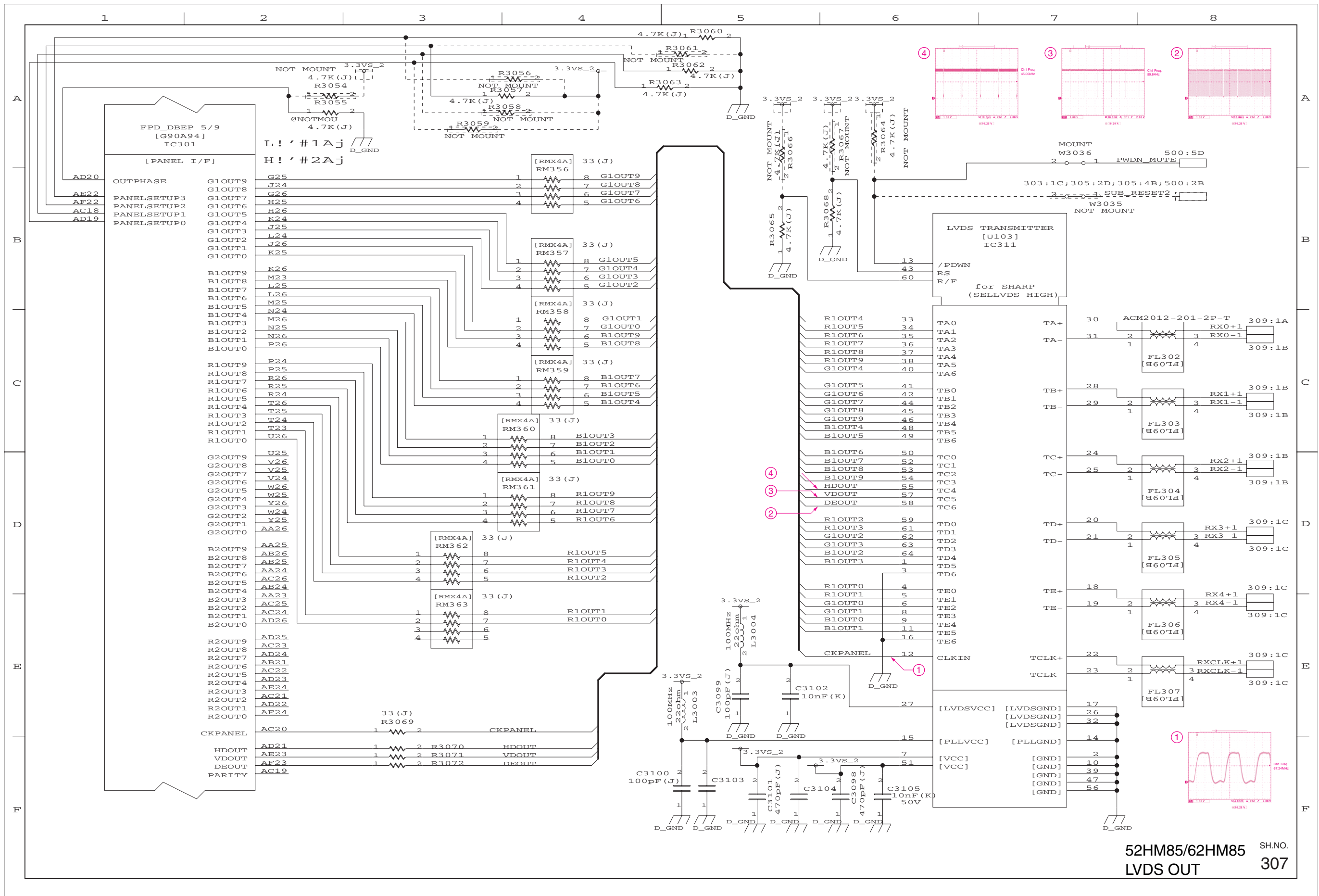

1 2 3 4 5 6 7 8

A  
B  
C  
D  
E  
F

A  
B  
C  
D  
E  
F

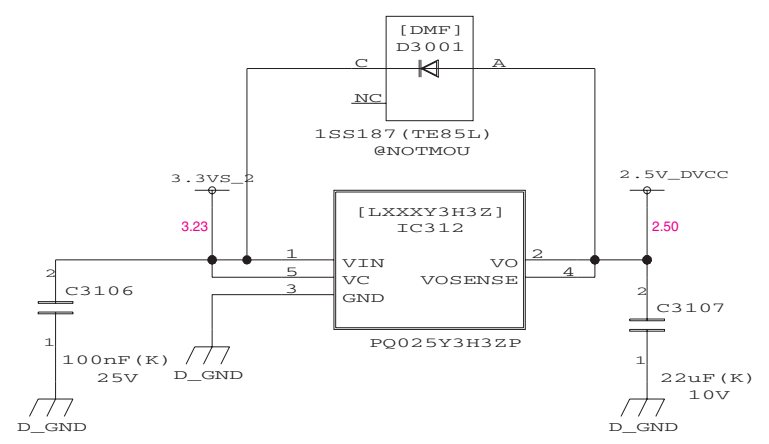

52HM85/62HM85  
Power (3.3V\_2 to 2.5V\_DVCC)

SH.NO.  
308

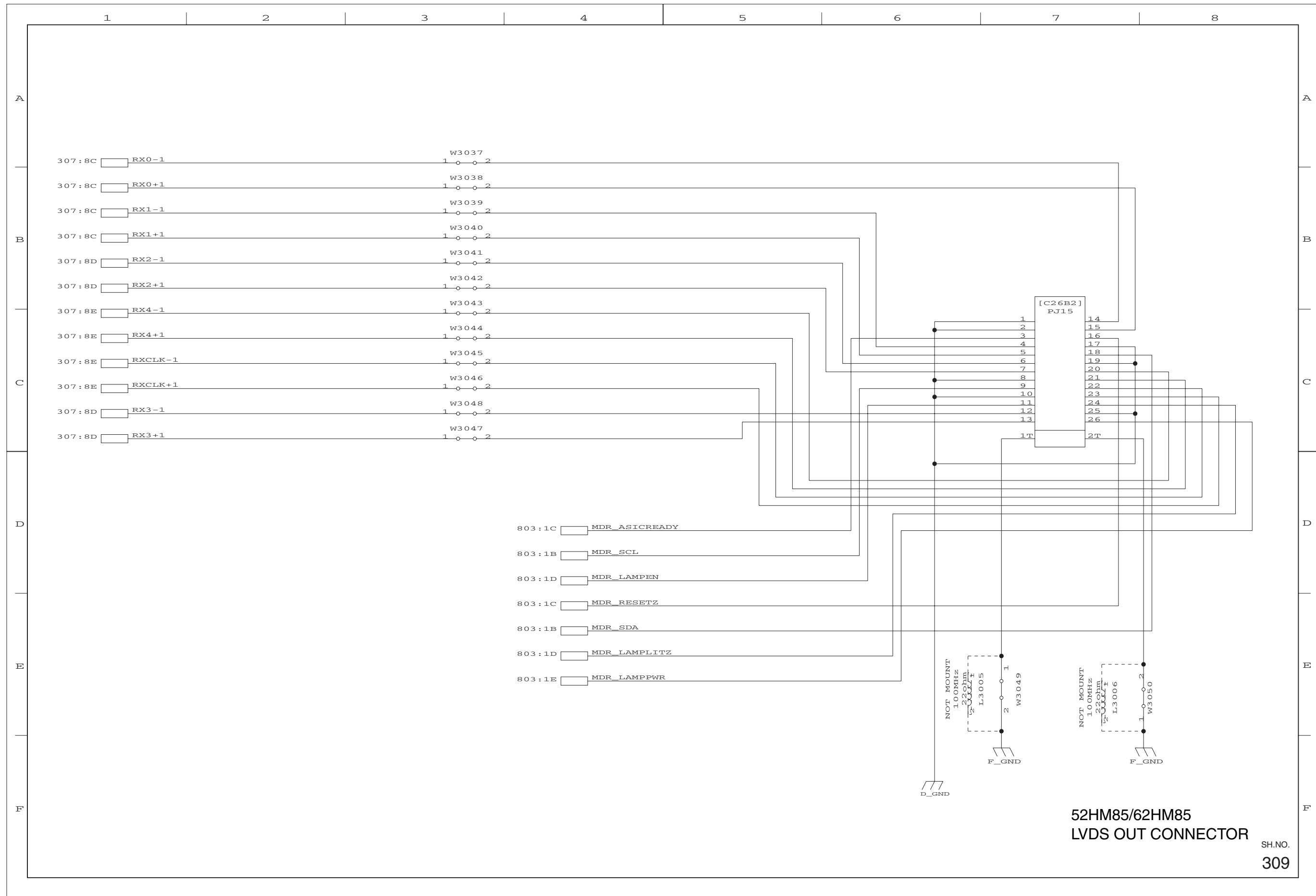

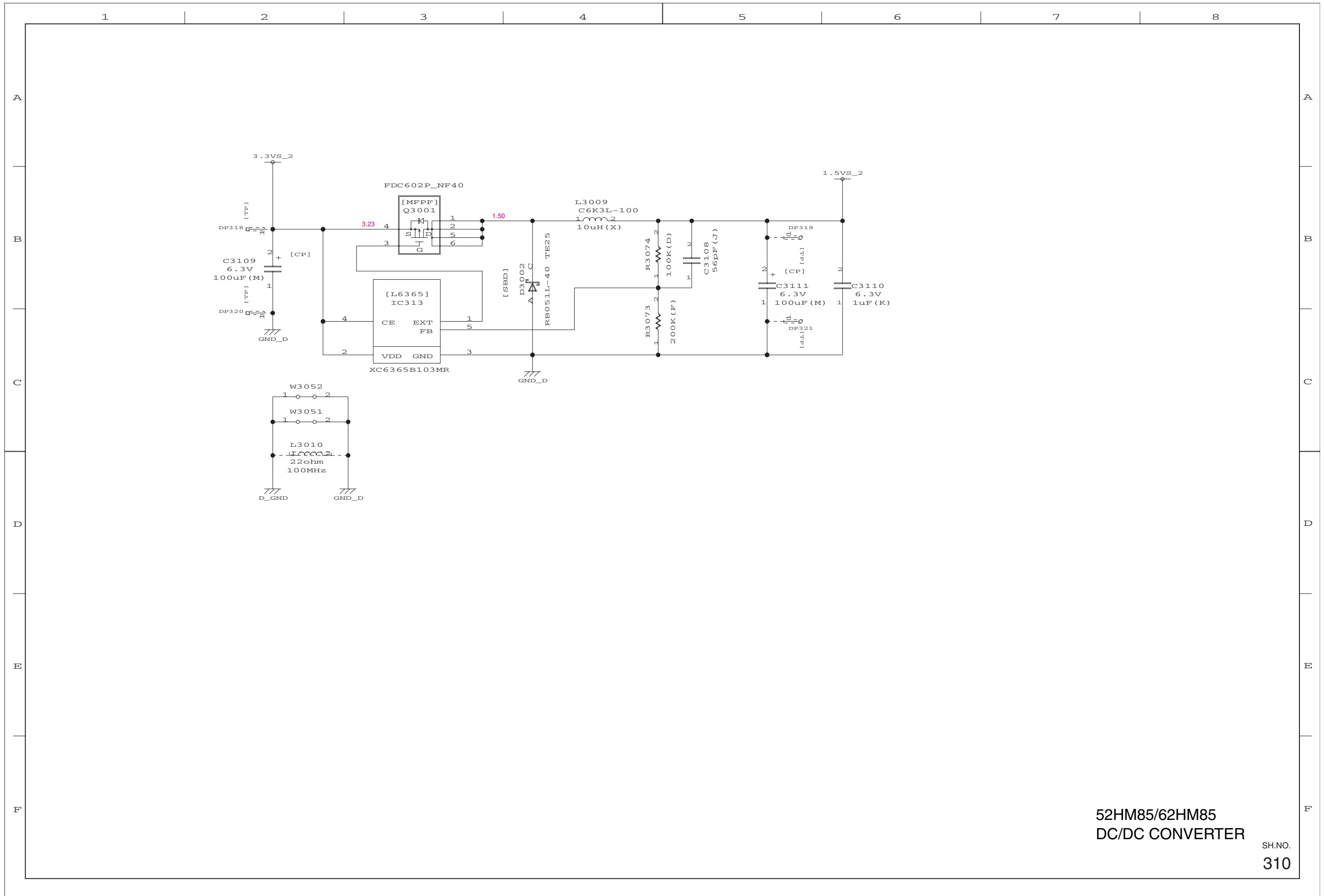

52HM85/62HM85  
DC/DC CONVERTER

SH.NO.  
310

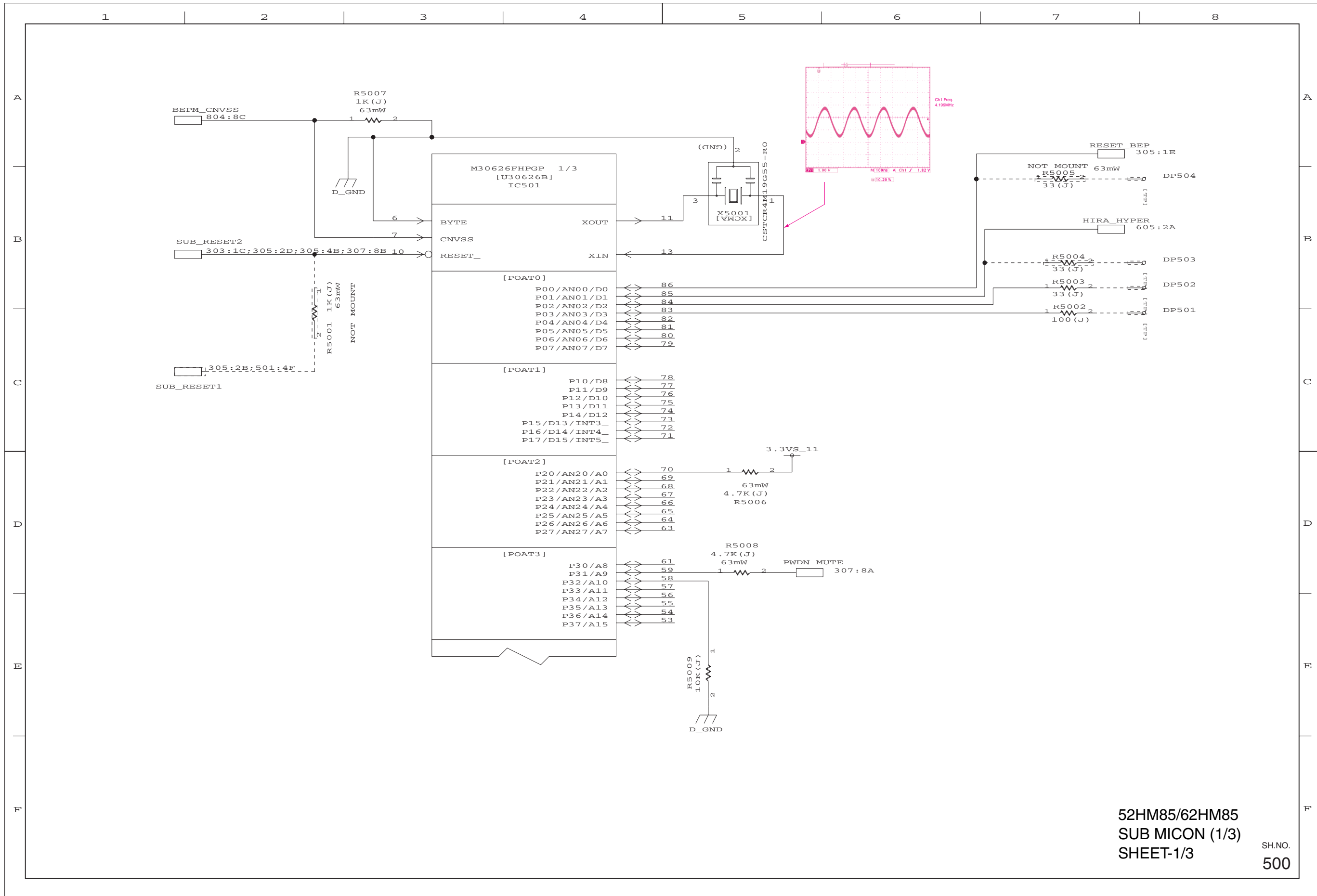

52HM85/62HM85  
 SUB MICON (1/3)  
 SHEET-1/3

SH.NO.  
 500

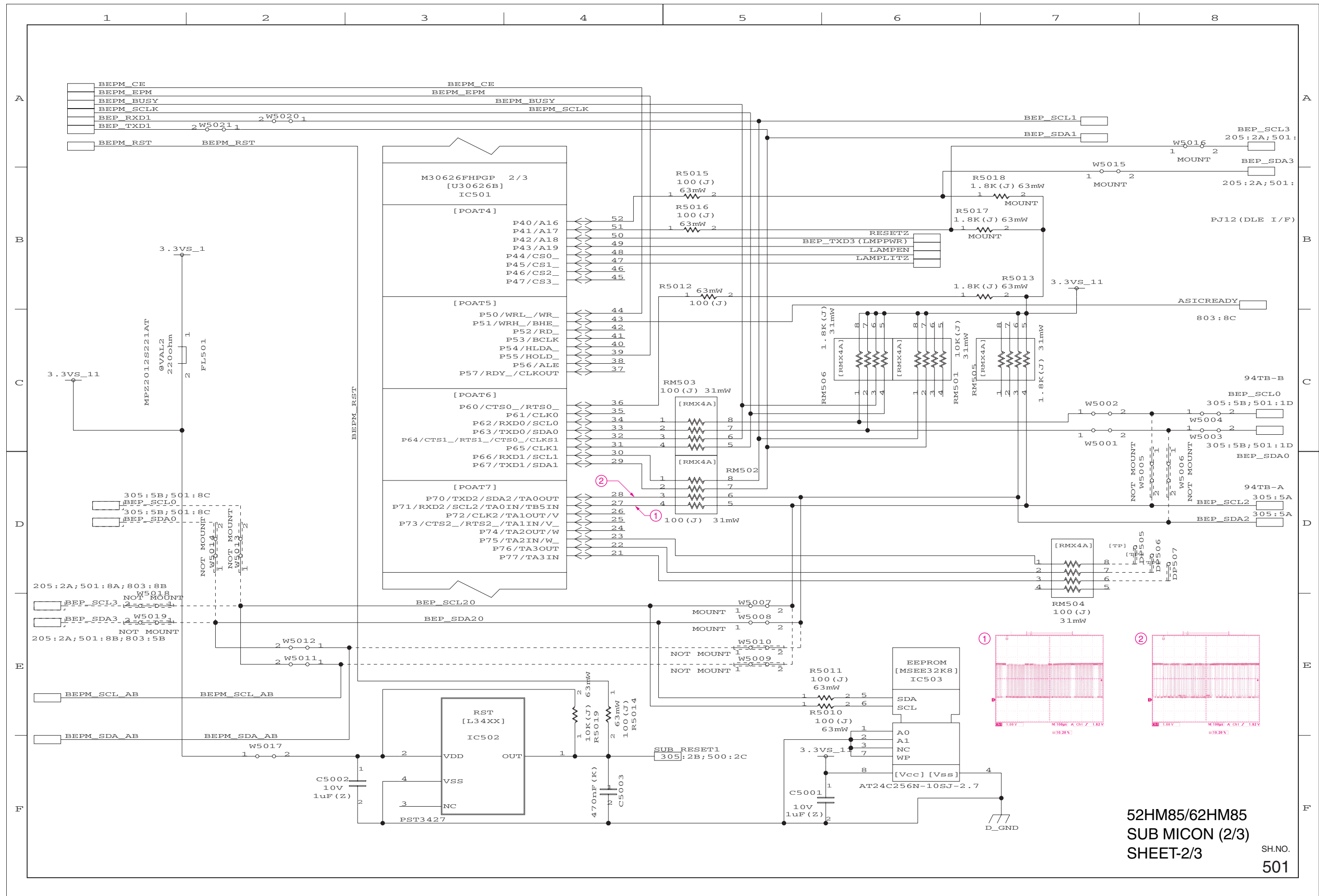

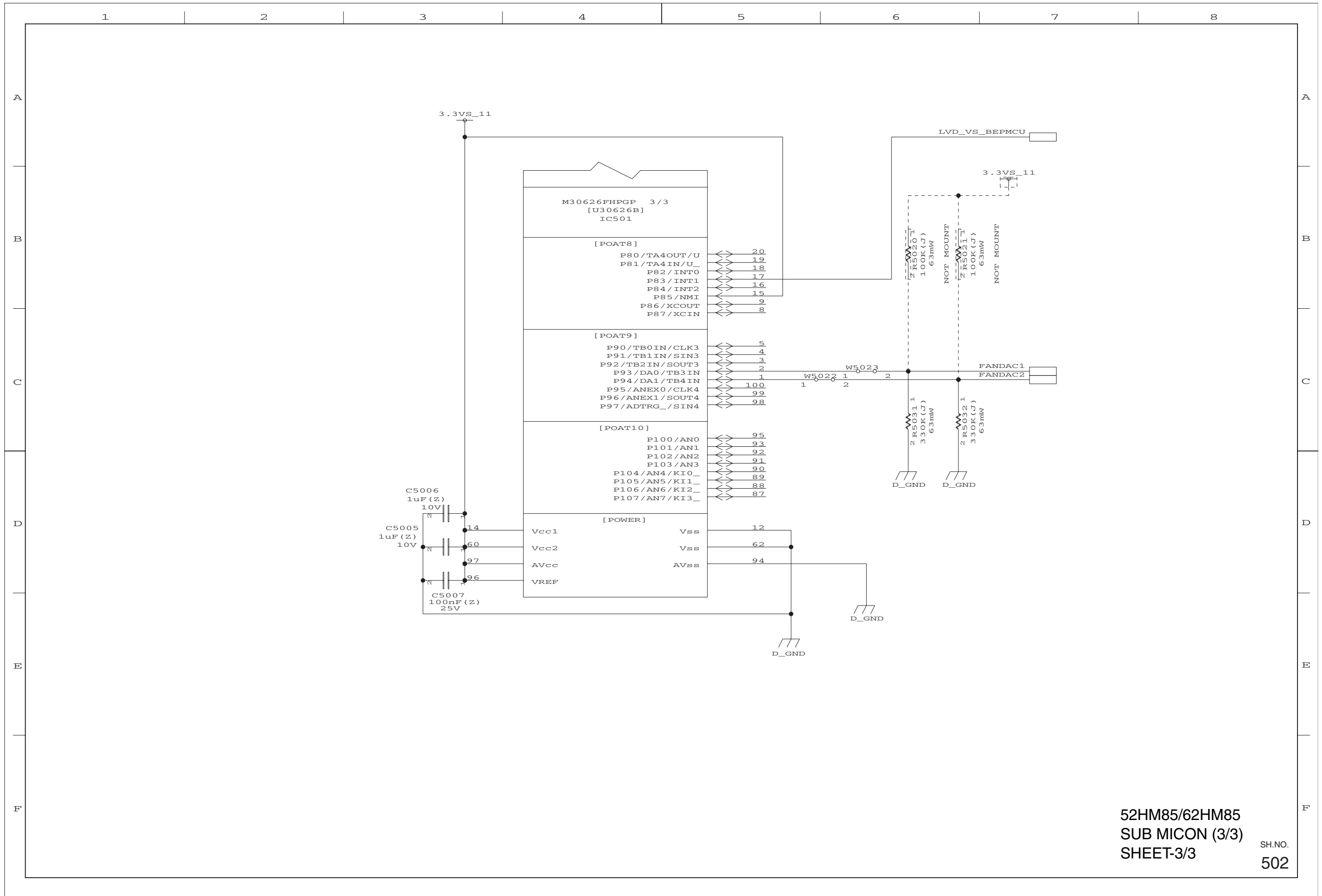

52HM85/62HM85  
 SUB MICON (3/3)  
 SHEET-3/3  
 SH.NO.  
 502

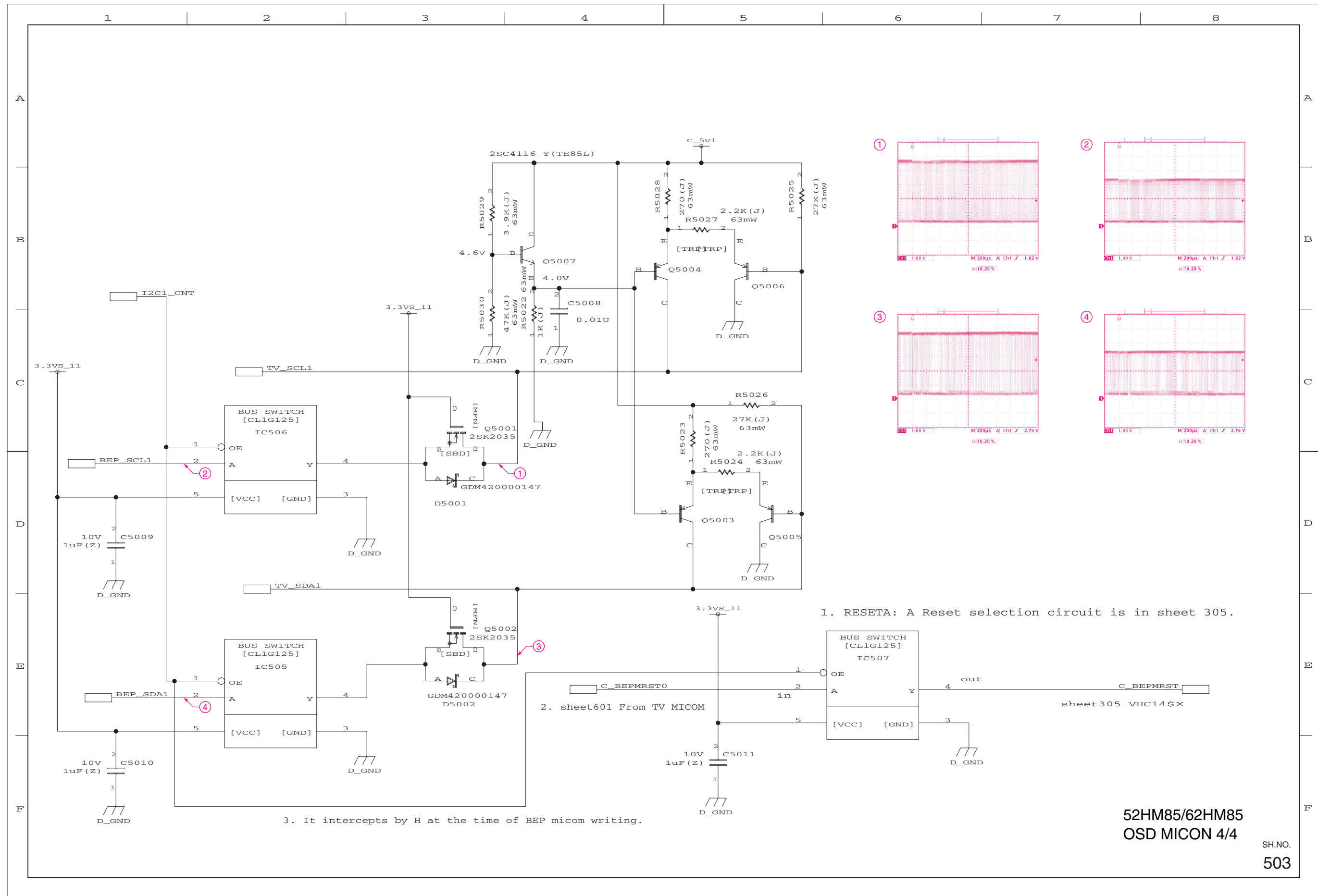

1. RESETA: A Reset selection circuit is in sheet 305.

2. sheet601 From TV MICOM

3. It intercepts by H at the time of BEP micom writing.

52HM85/62HM85  
OSD MICON 4/4

SH.NO.  
503



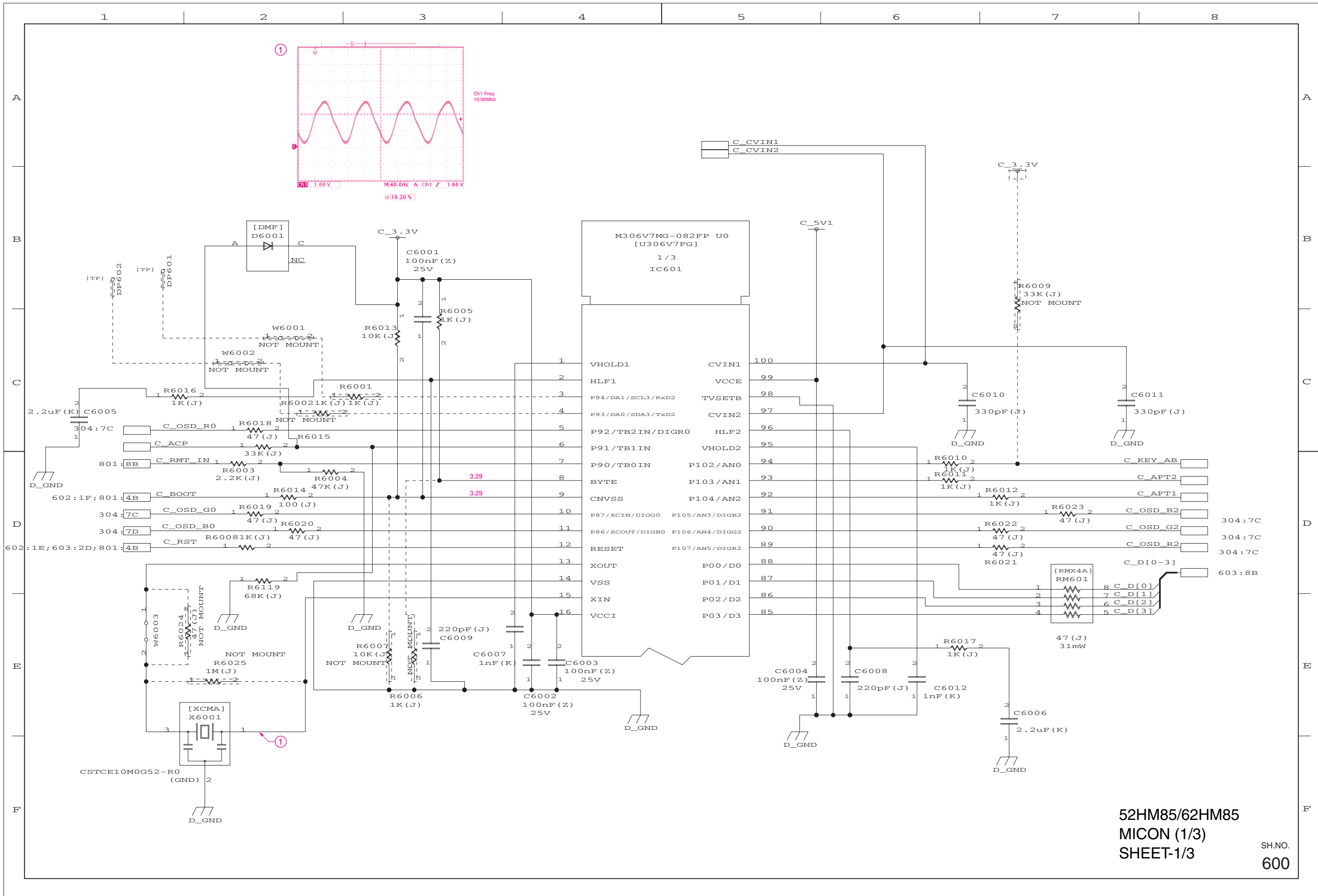

52HM85/62HM85  
MICON (1/3)  
SHEET-1/3

SH.NO.  
600

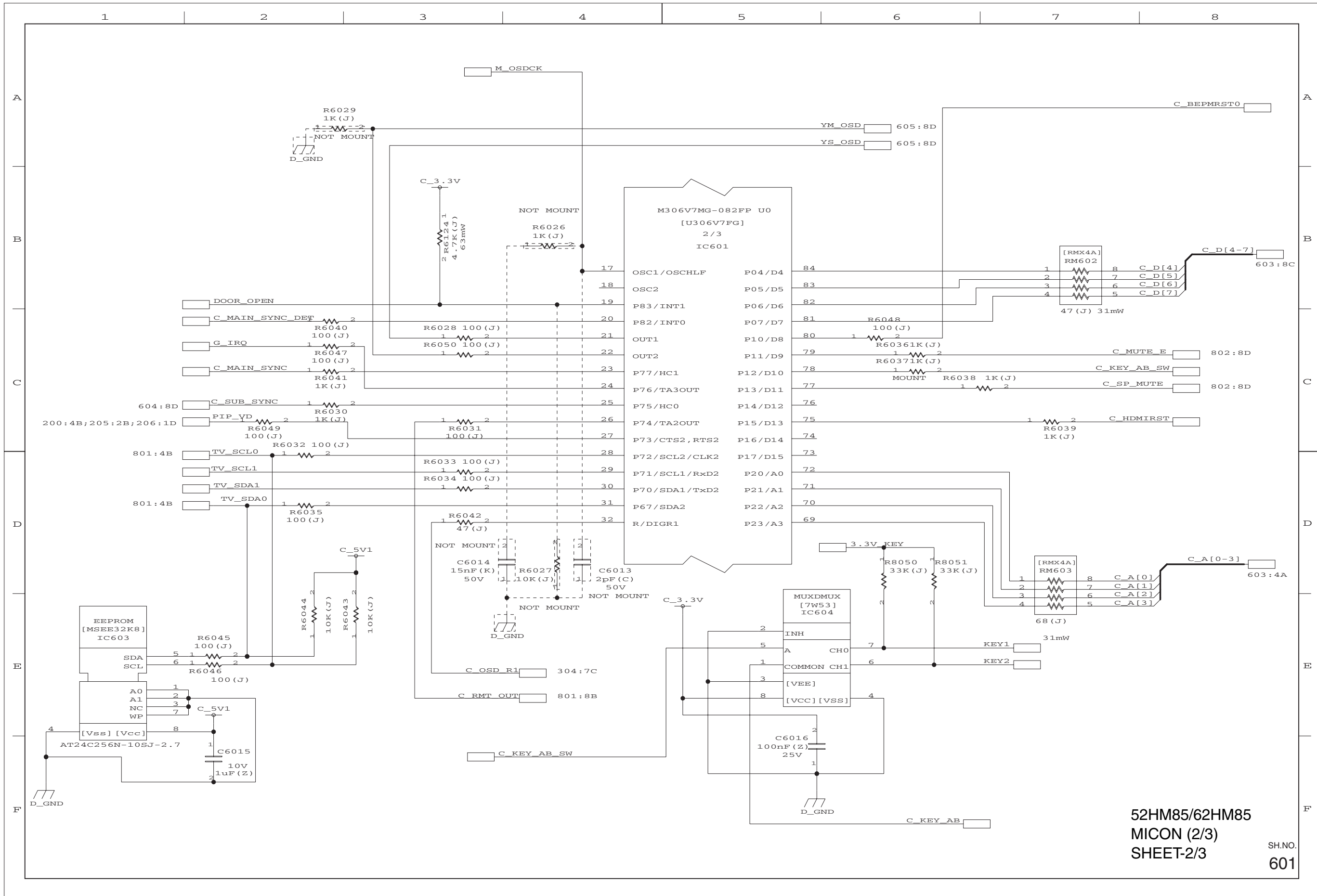

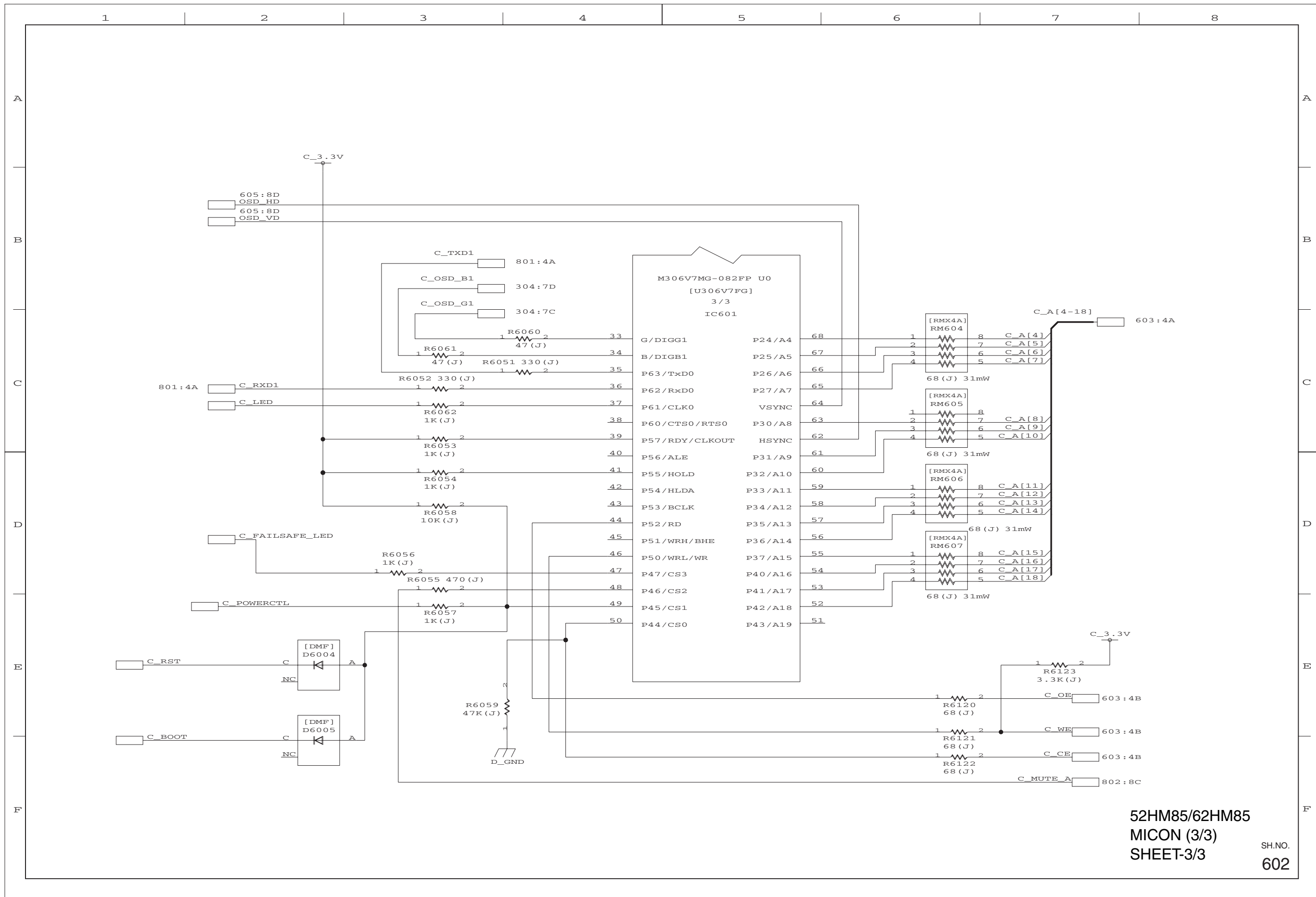

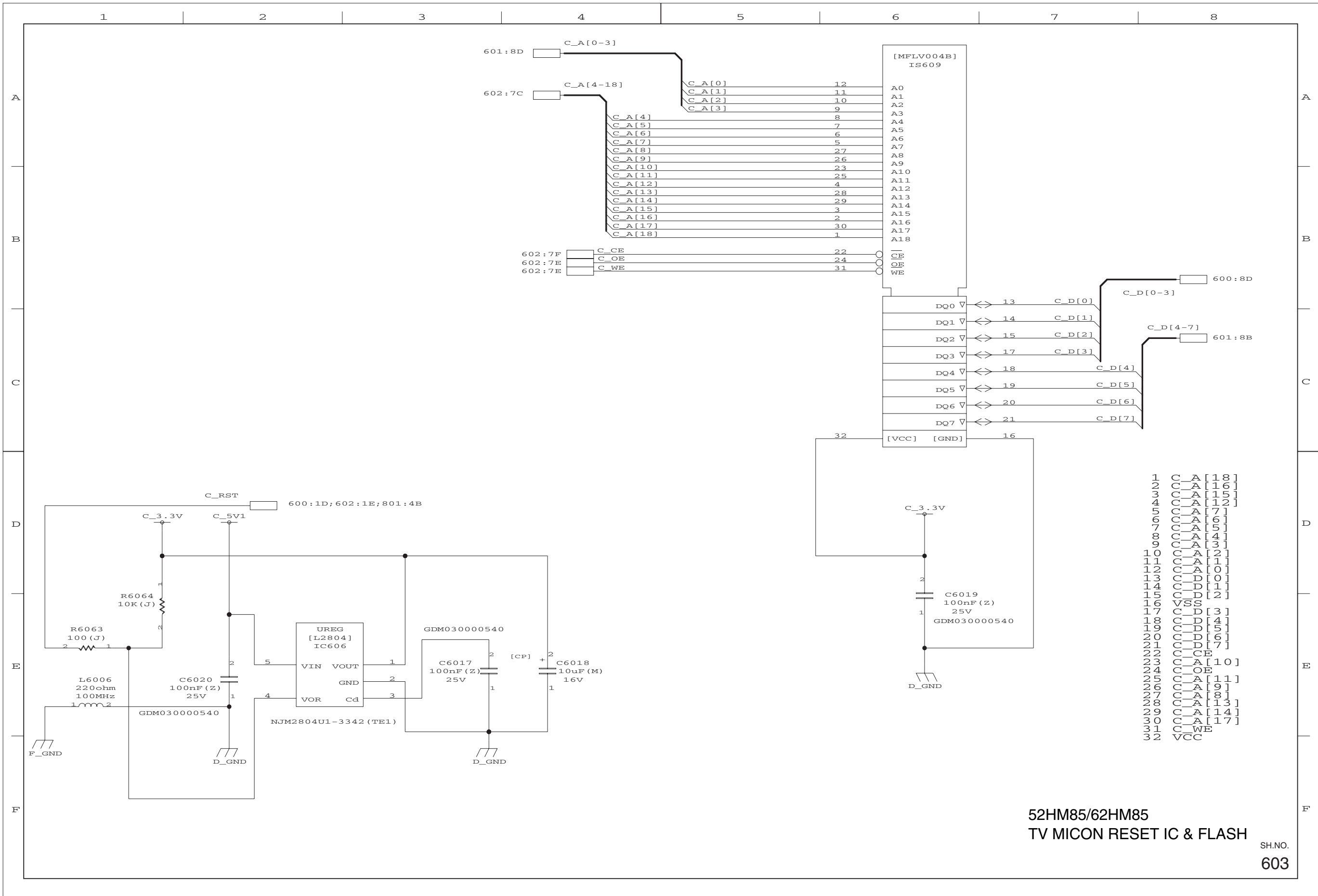

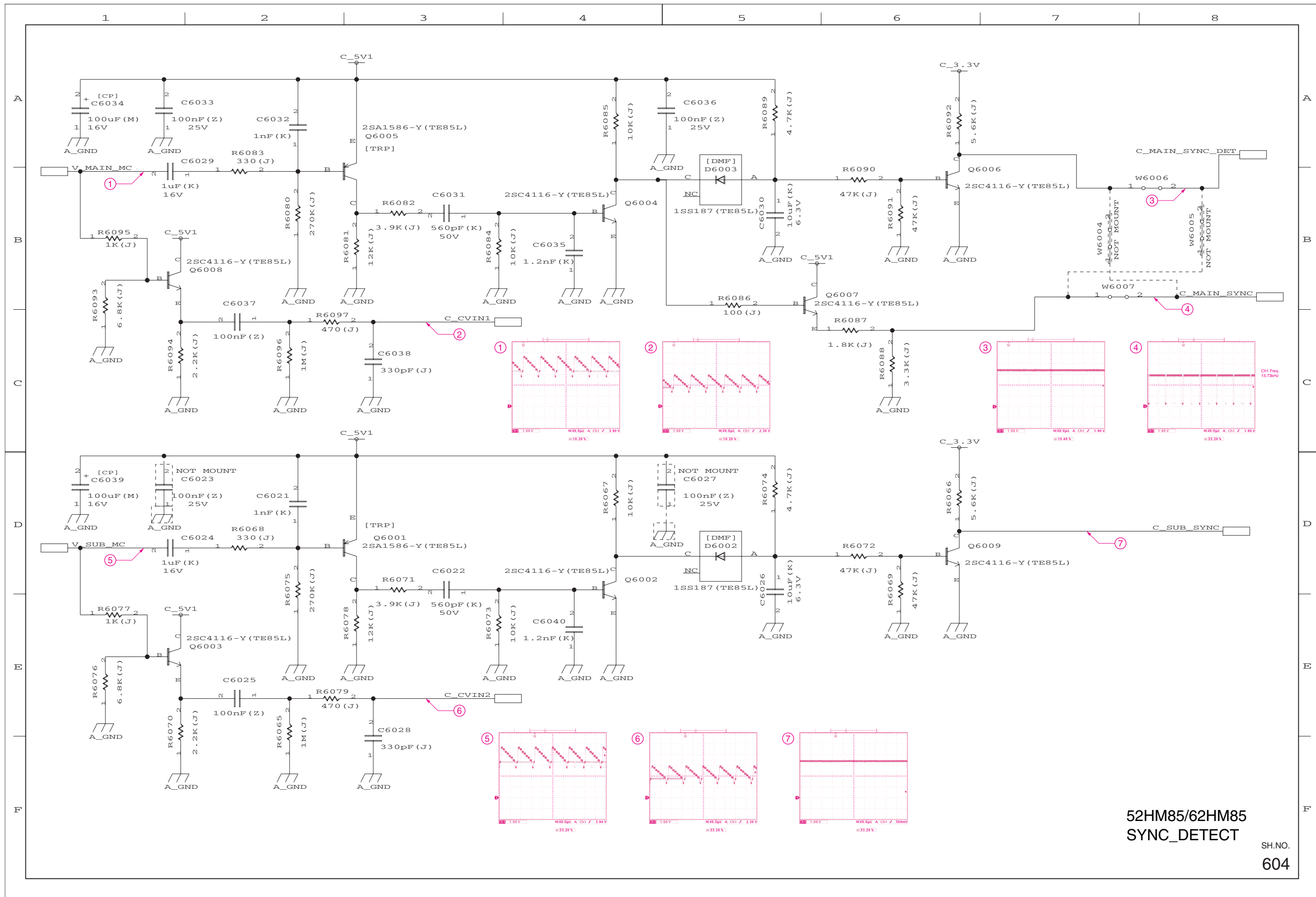

52HM85/62HM85  
SYNC\_DETECT

SH.NO.  
604

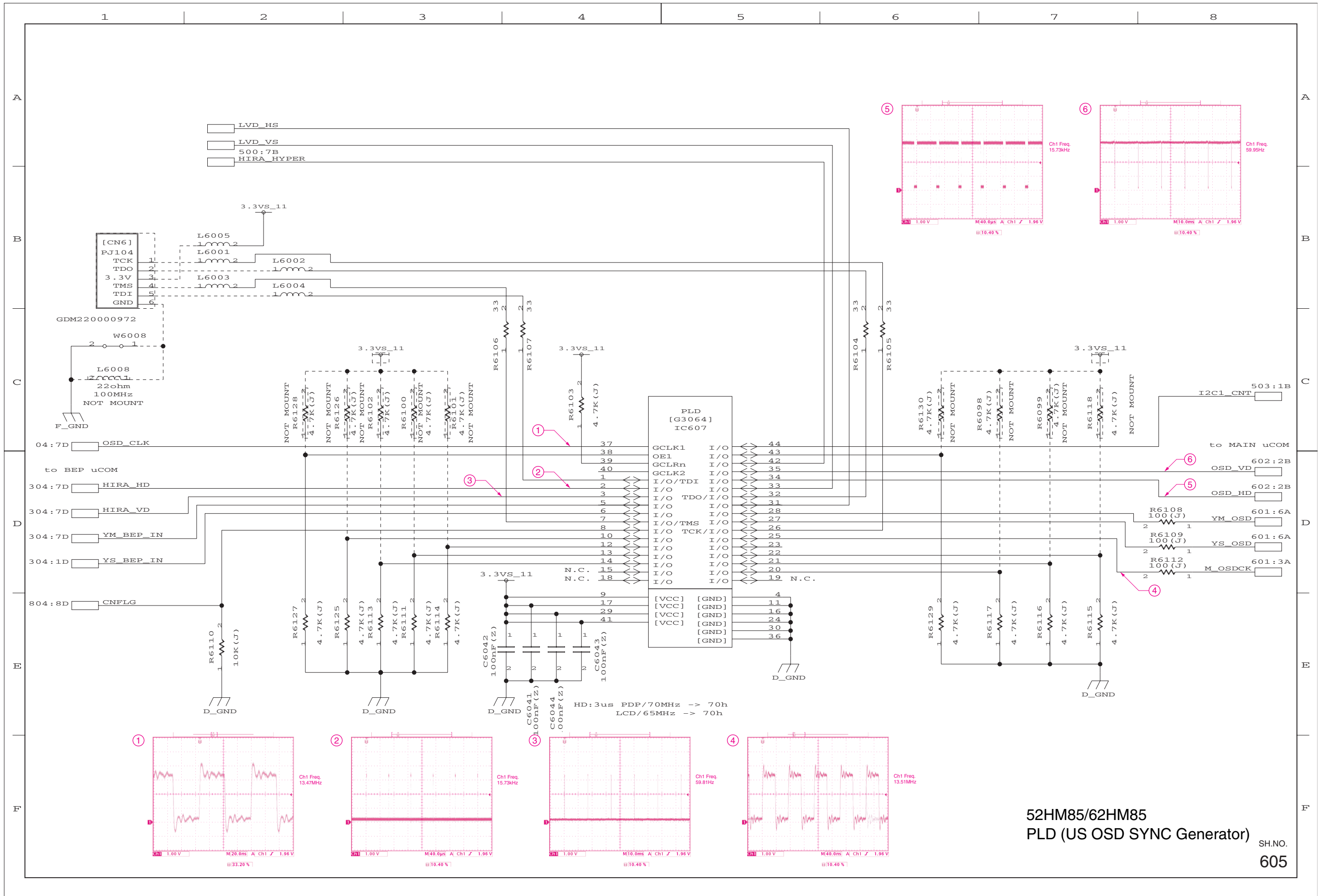

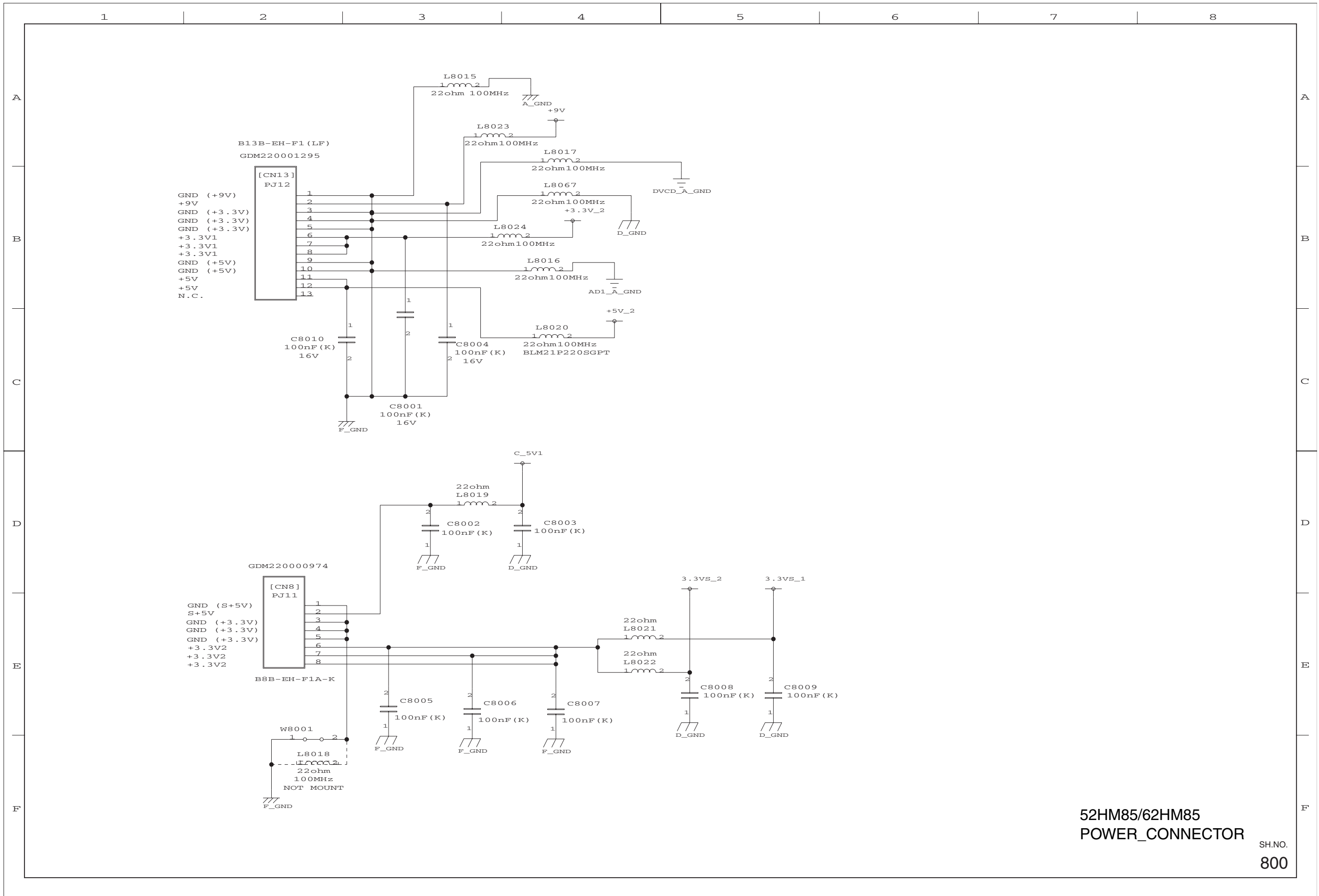

52HM85/62HM85  
POWER\_CONNECTOR

SH.NO.  
800

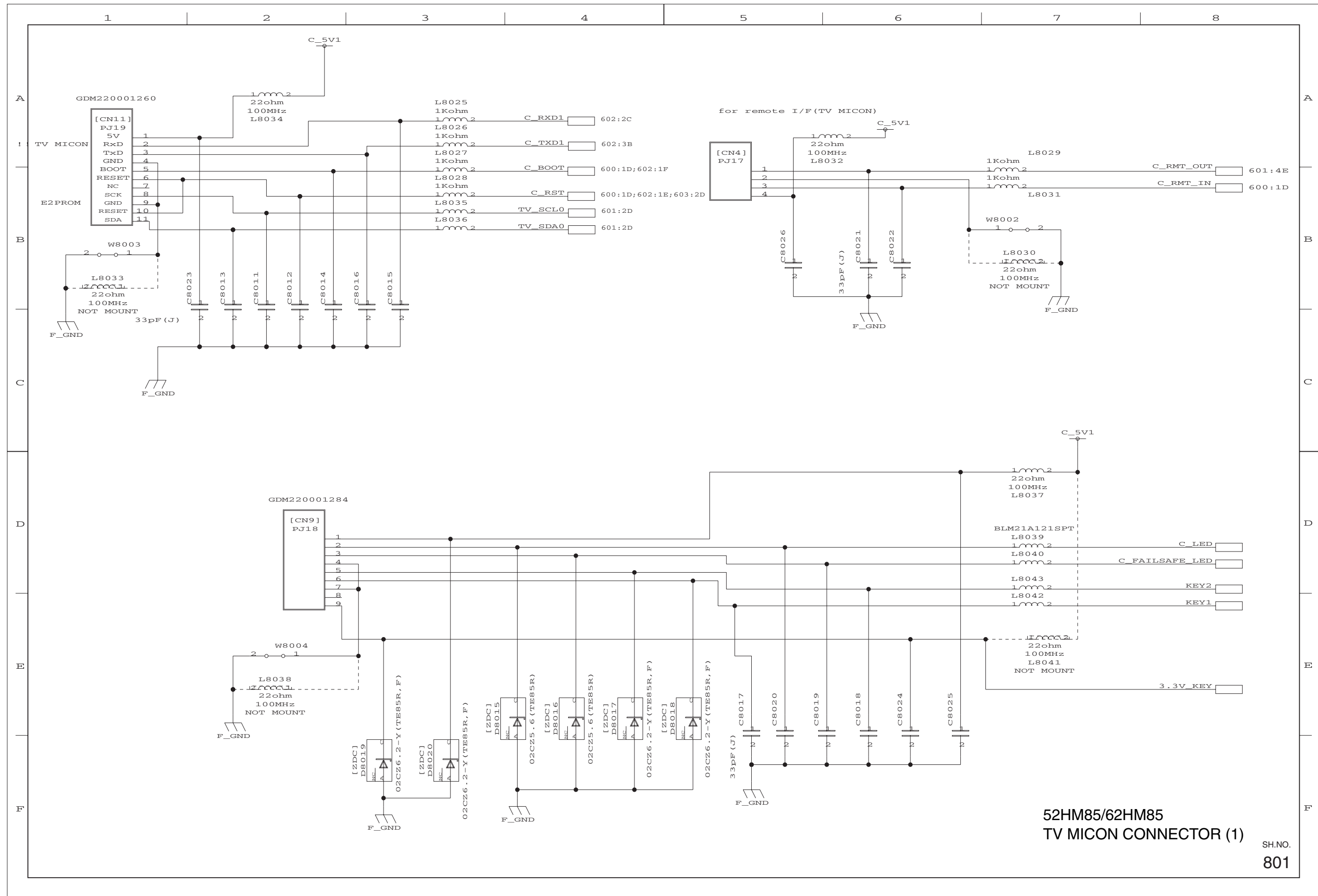



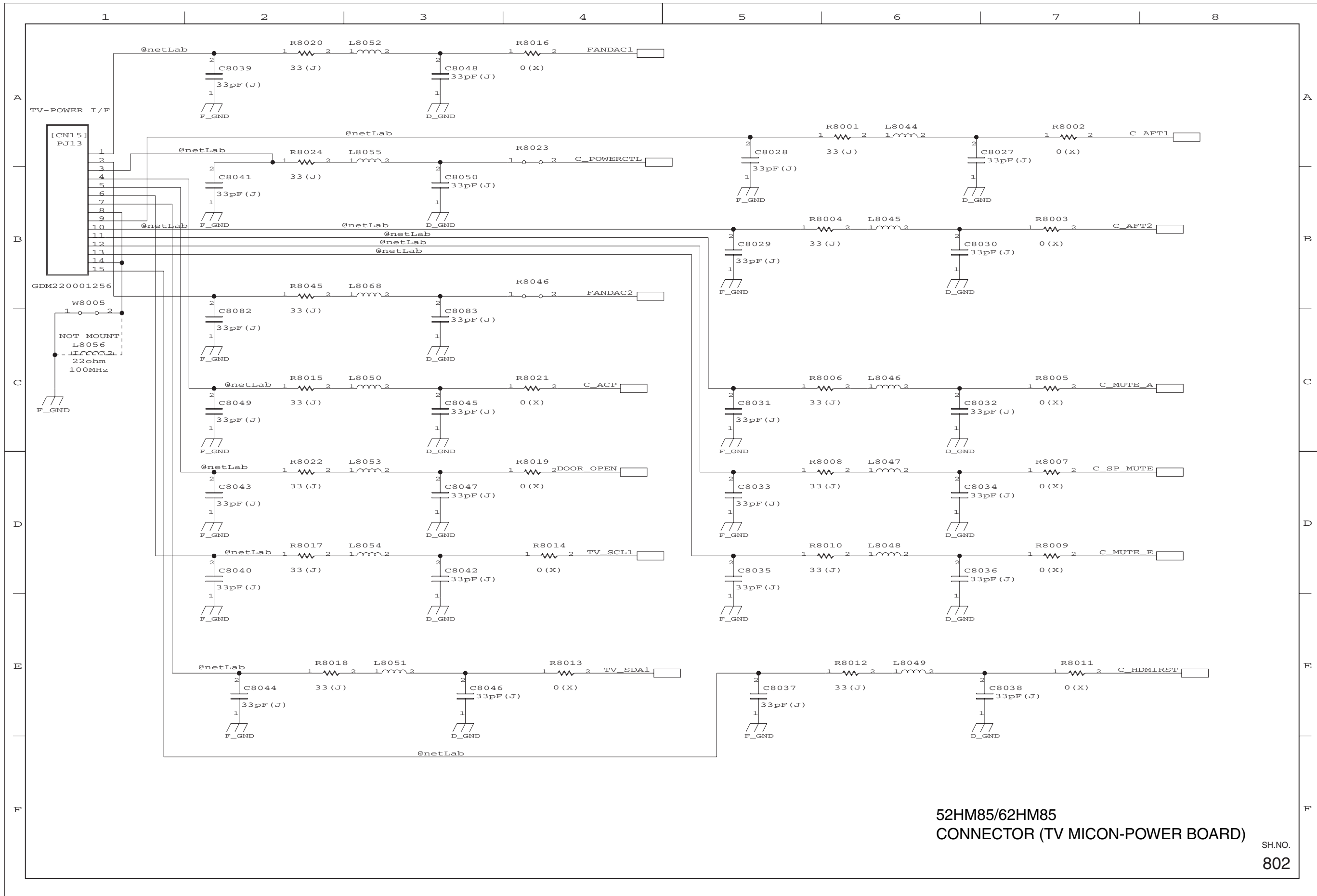

52HM85/62HM85  
CONNECTOR (TV MICON-POWER BOARD)

SH.NO.  
802

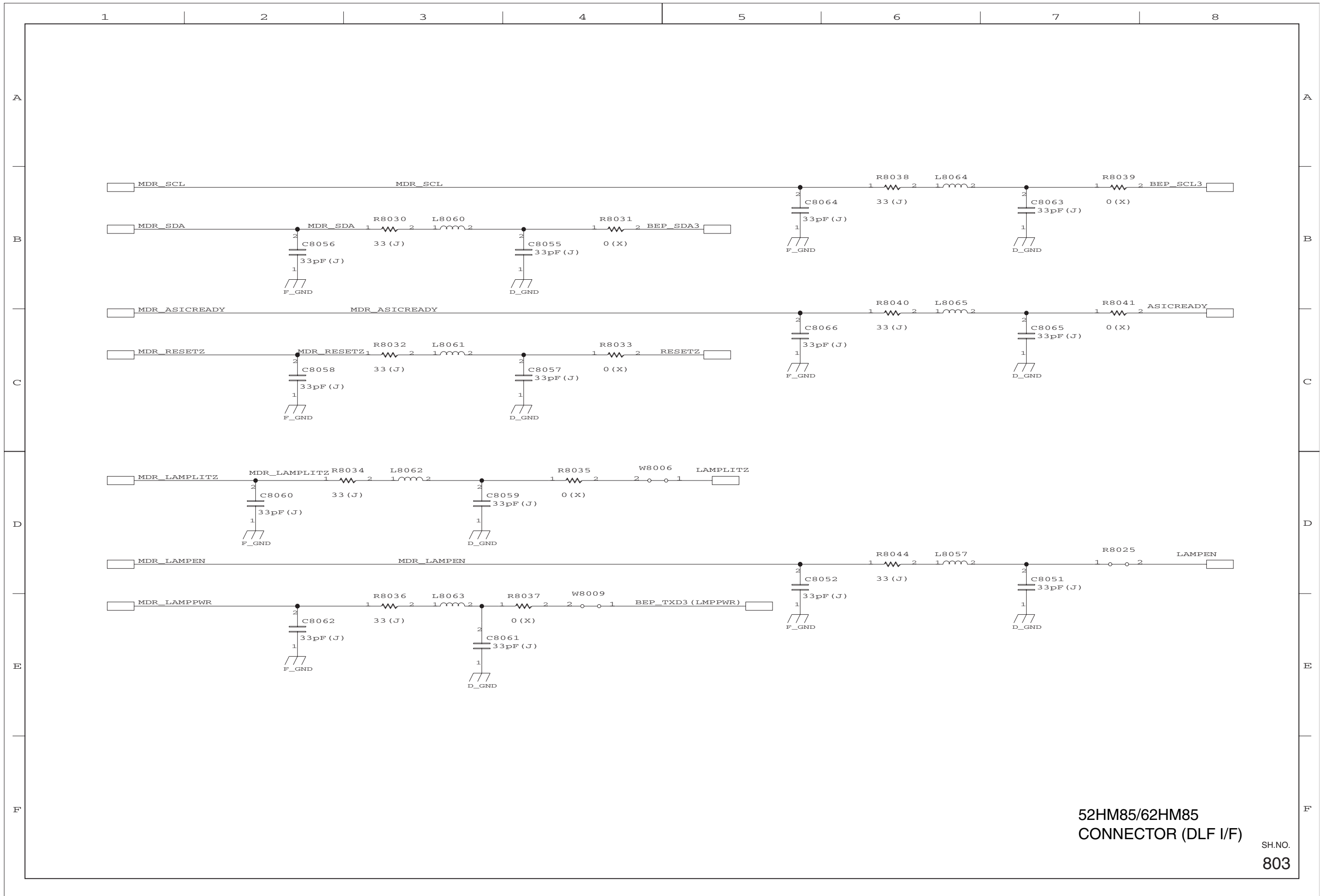

52HM85/62HM85  
CONNECTOR (DLF I/F)

SH.NO.  
803

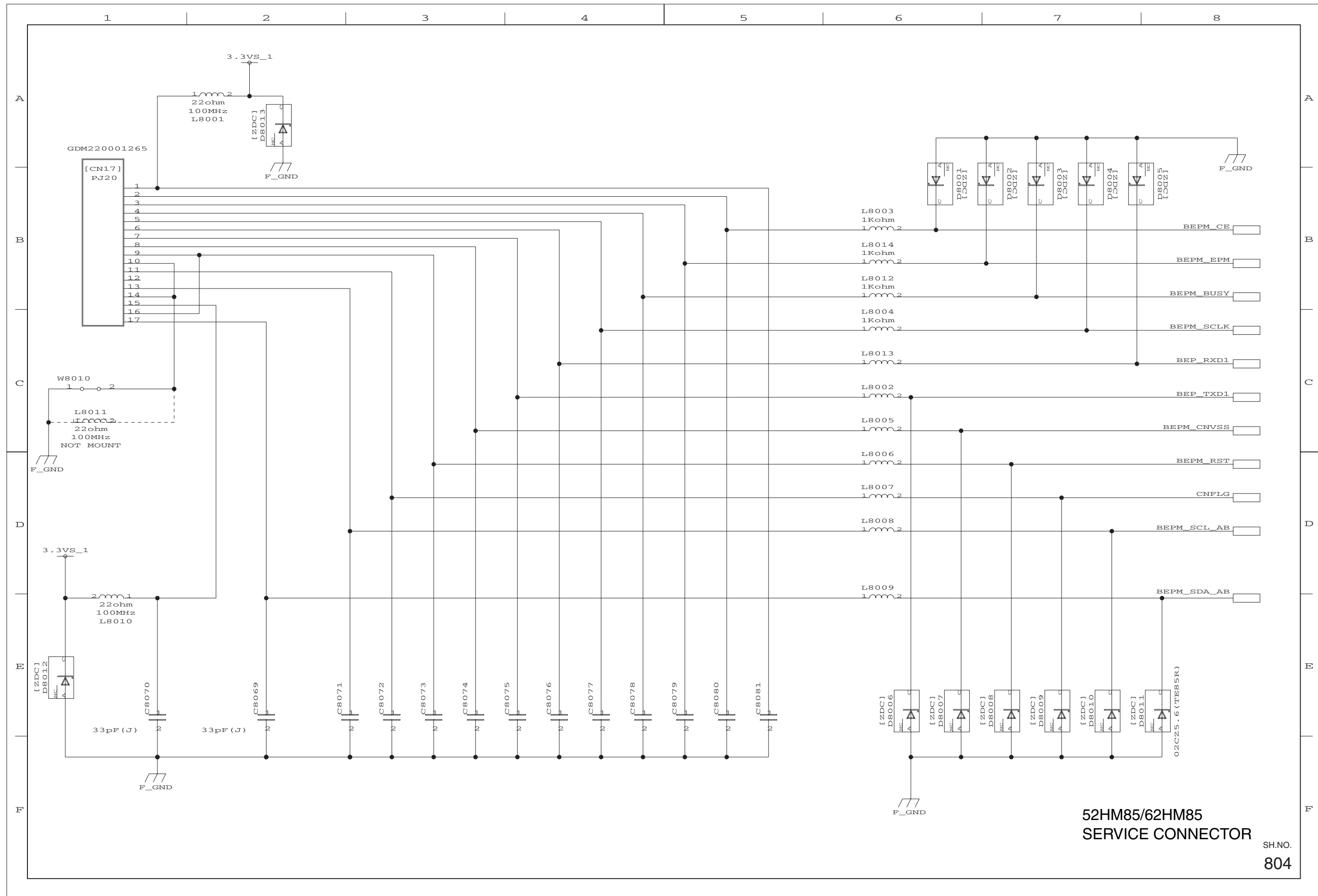

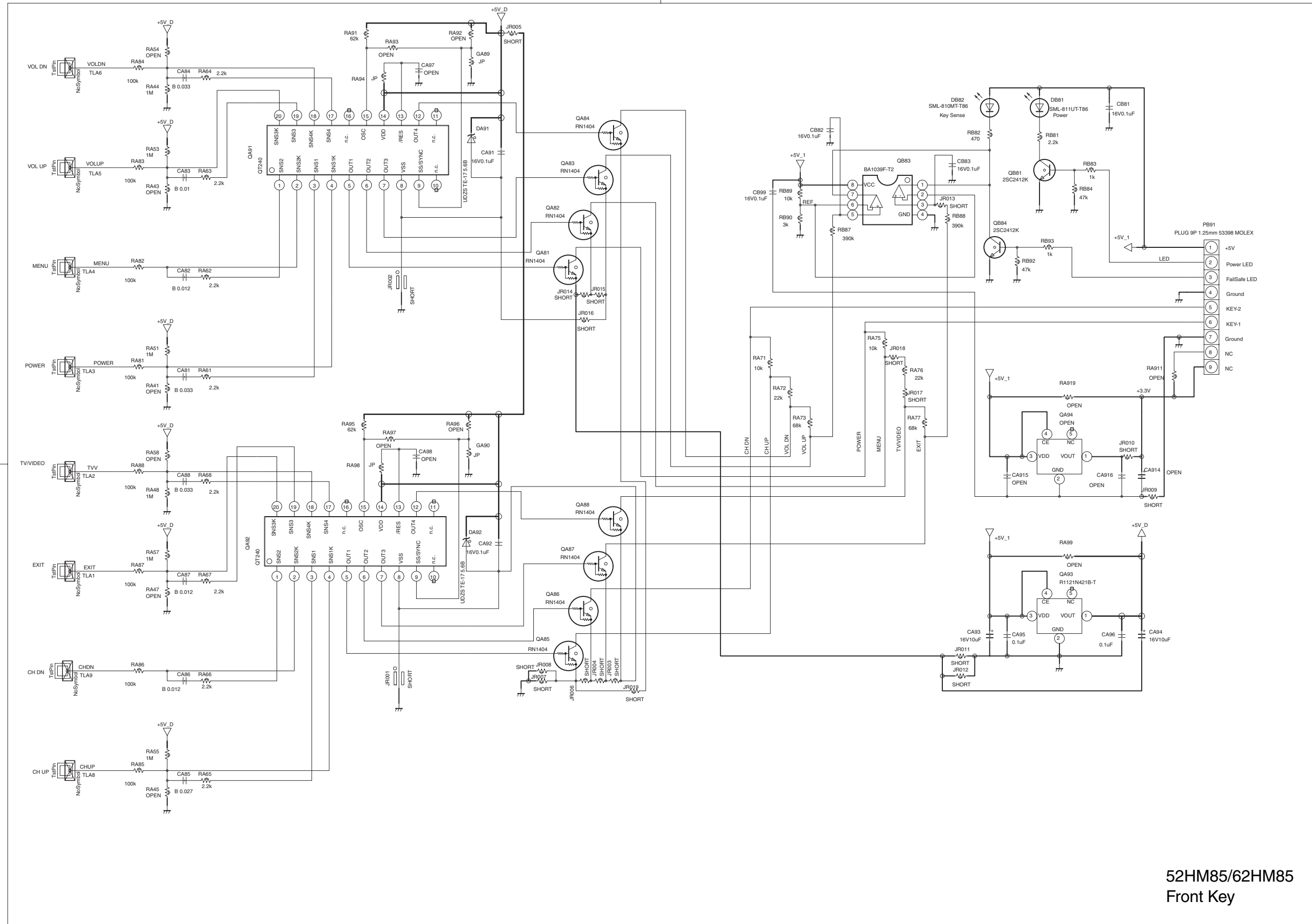

52HM85/62HM85  
Front Key

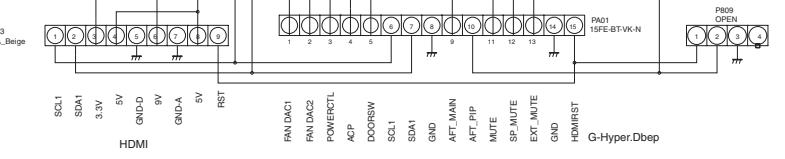
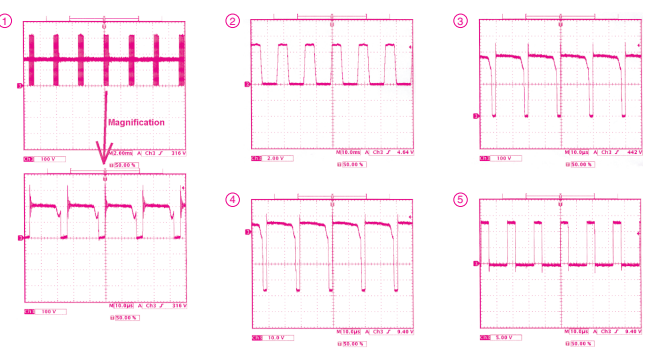
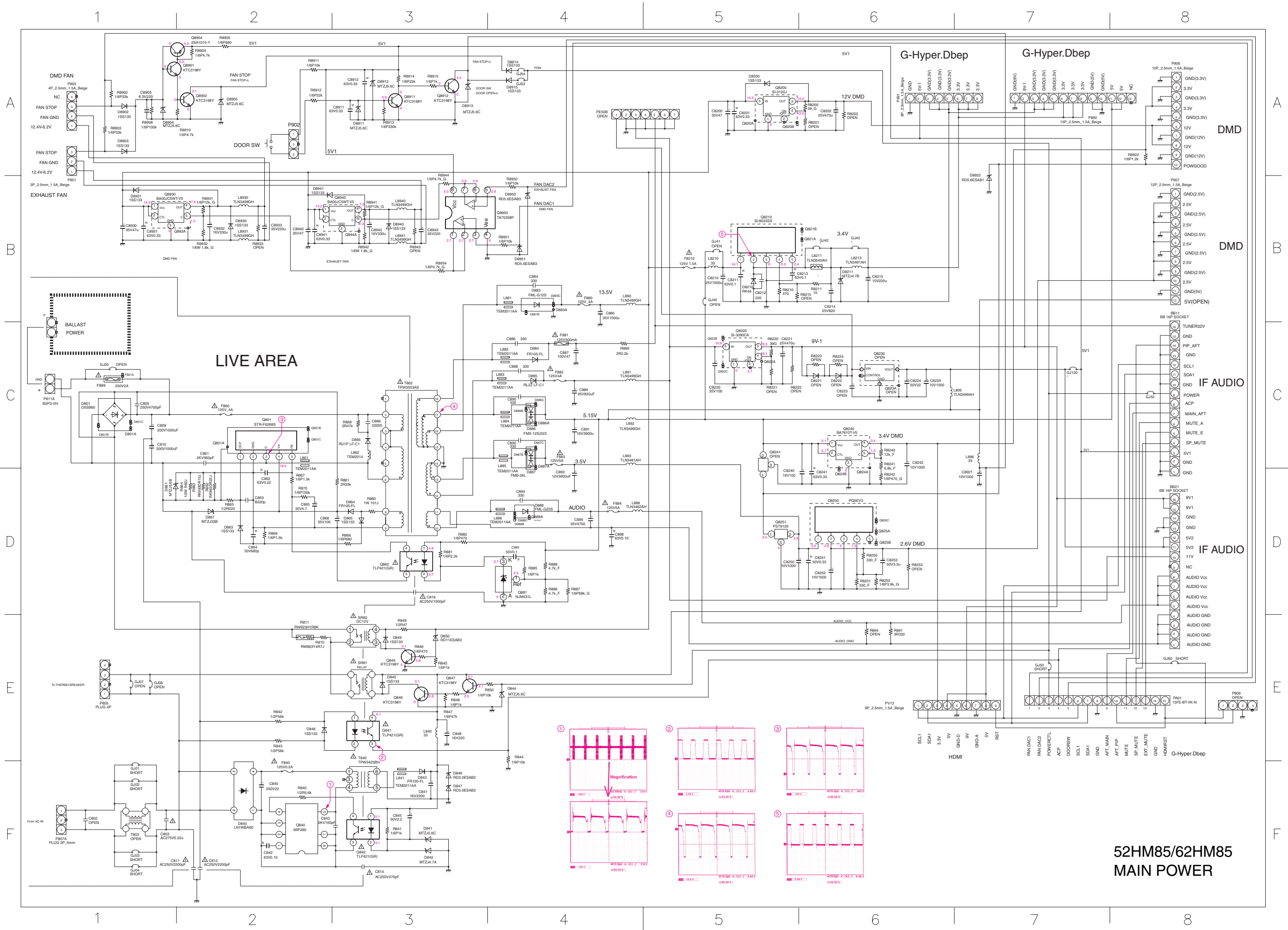

52HM85/62HM85  
MAIN POWER

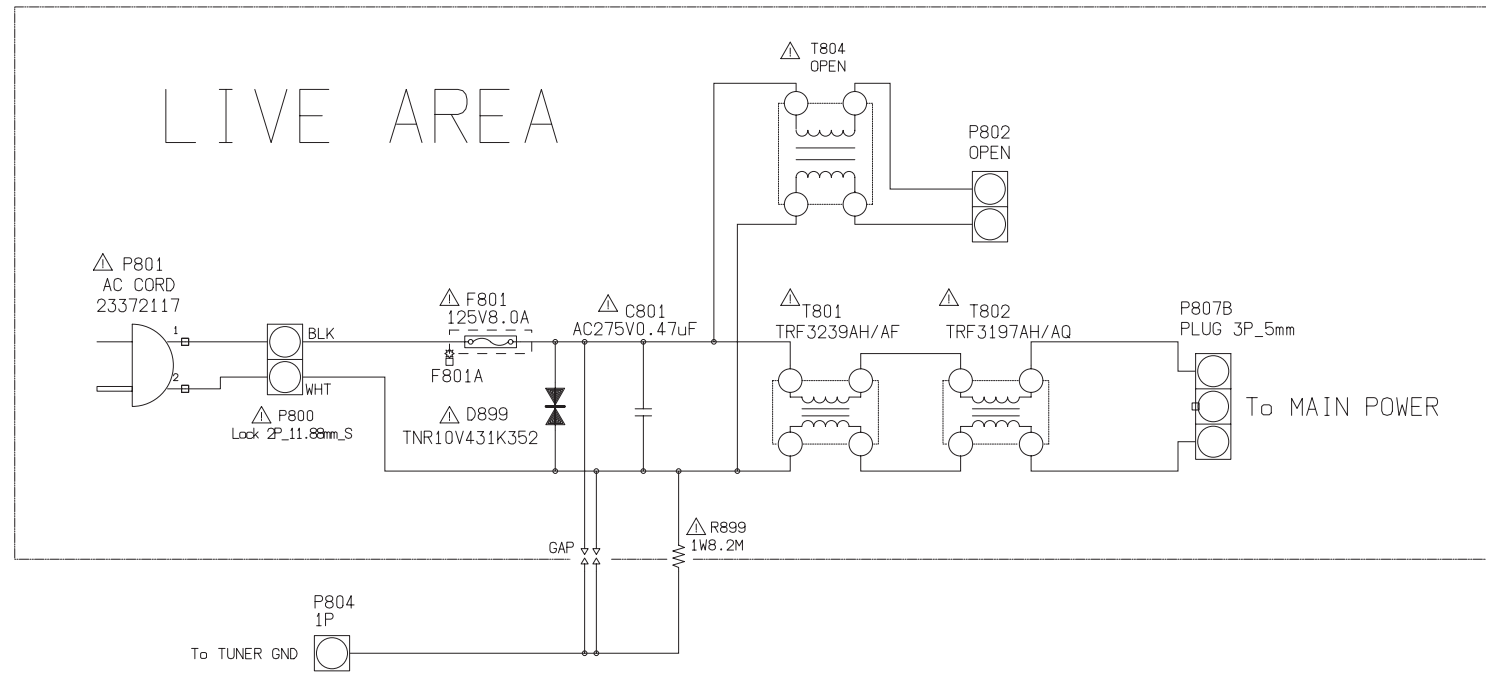

52HM85/62HM85  
AC IN

**TOSHIBA CORPORATION**  
1-1, SHIBAURA 1-CHOME, MINATO-KU, TOKYO 105-8001, JAPAN