

1.8°57mm

混合式步进电机参数 Hybrid Stepper Motor

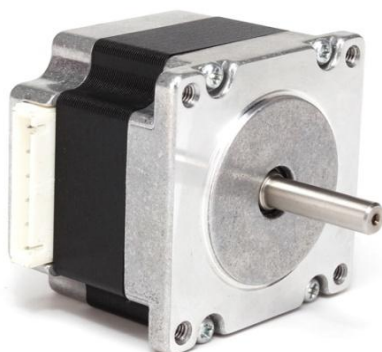

通用参数 General Specifications

Item	Specifications
步距角 Step Angle	1.8°
步距角精度 Step Angle Accuracy	±5%
电阻精度 Resistance Accuracy	±10%
电感精度 Inductance Accuracy	±20%
温升 Temperature Rise	80°C Max(Rated Current,2 phase power)
工作环境温度 Ambient Temperature	-20°C - +50°C
绝缘电阻 Insulation Resistance	100MΩMin,500VDC
介电强度 Dielectric Strength	500VAC,1 minute
径向跳动 Radial Runout	0.02 Max.(450g load)
轴向跳动 Axial Runout	0.08 Max.(450g load)
径向负载 Radial Load	75N(20mm from Flange)
轴向负载 Axial Load	15N

性能规格书 The Performance Specification

型号	保持转矩	额定电流	相电阻	相电感	定位转矩	转动惯量	出线数	机身长度
Modle	Holding torque (mN.m)	Rated Current (A)	Resistance (Ω)	Inductance (mH)	Detent Torque (mN.m)	Rotor Inertia (g.cm ²)	Leads (No.)	Motor Length (mm)
57HS0603-XX	390	1	5.7	5.4	21	120	6	41
57HS0602-XX	390	2	1.4	1.4			6	
57HS0601-XX	390	3	0.63	0.6			6	
57HS0406-XX	550	2.8	0.7	1.4			4	
57HS3604-XX	720	1	6.6	8.2	36	275	6	51
57HS3605-XX	720	2	1.65	2.2			6	
57HS3606-XX	720	3	0.74	0.9			6	
57HS3409-XX	1001	2.8	0.83	2.3			4	
57HS5603-XX	900	1	7.4	10	40	300	6	56
57HS5602-XX	900	2	1.8	2.5			6	
57HS5601-XX	900	3	0.75	1.1			6	
57HS5406-XX	1260	2.8	0.9	2.5			4	
57HS7603-XX	1350	1	8.6	14	68	480	6	76
57HS7602-XX	1350	2	2.25	3.6			6	
57HS7601-XX	1350	3	1	1.6			6	
57HS7401-XX	1890	2.8	1.13	3.6			4	
57HS9601-XX	1800	4	0.7	1.5	80	520	6	84
57HS11401-XX	3000	2.8	2.1	10	100	650	4	115

1.8°57mm

混合式步进电机参数 Hybrid Stepper Motor

尺寸图 Mechanical Dimensions

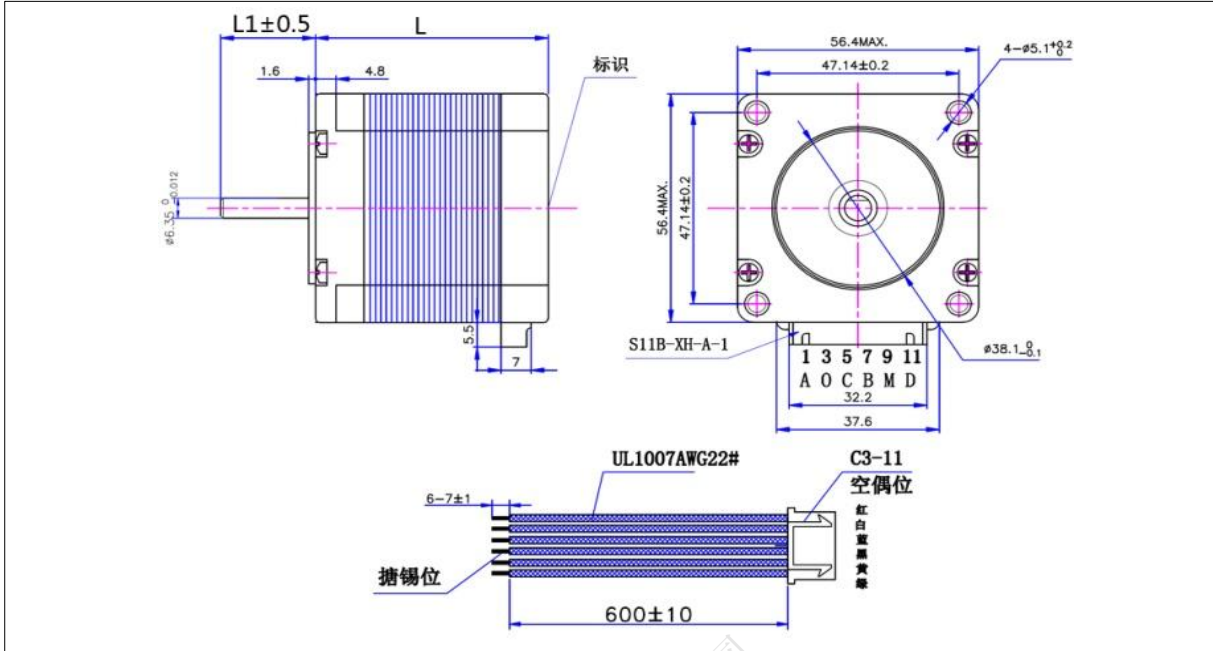

力矩曲线 Torque Curve

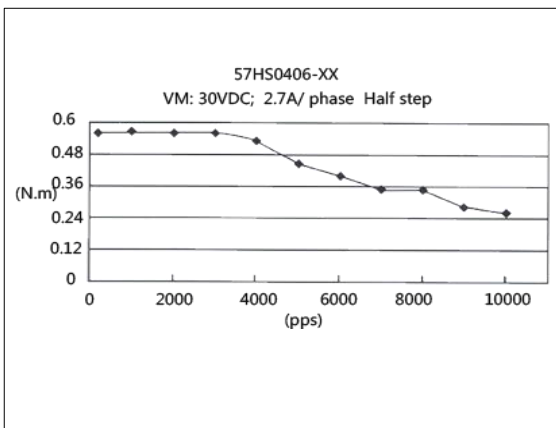
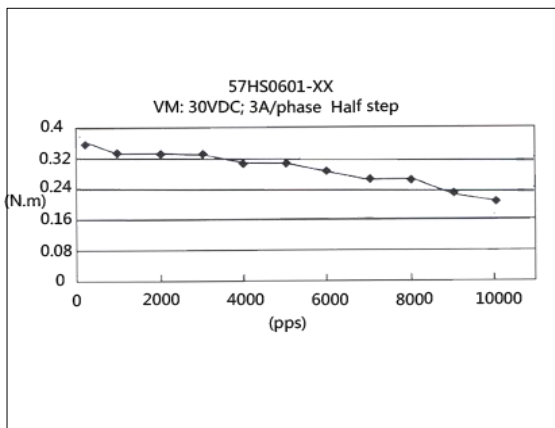
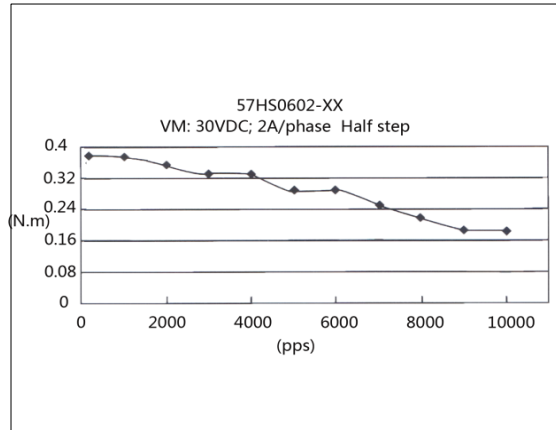
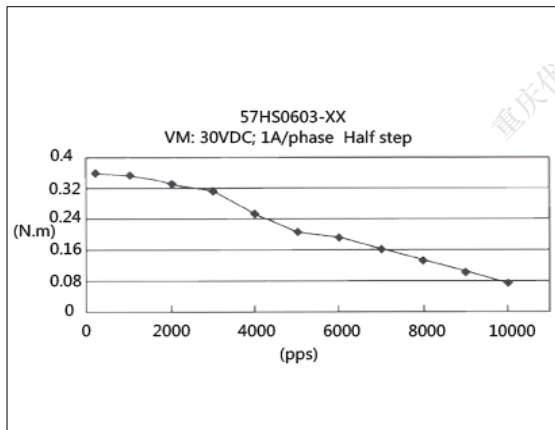

1.8°57mm

混合式步进电机参数 Hybrid Stepper Motor



力矩曲线 Torque Curve

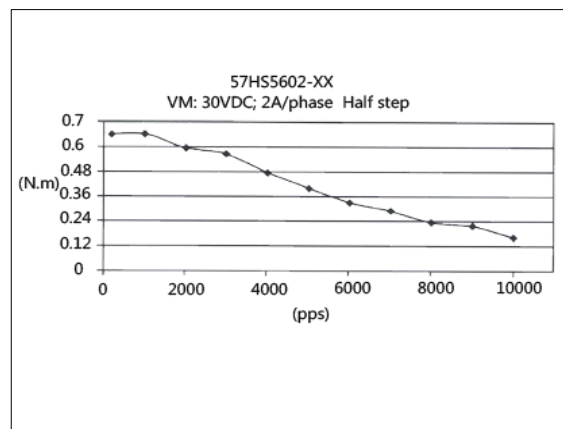
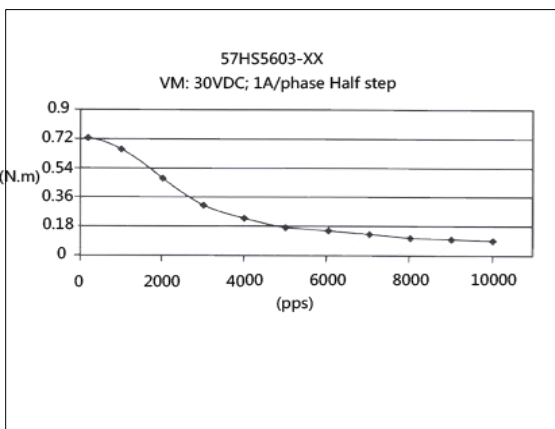
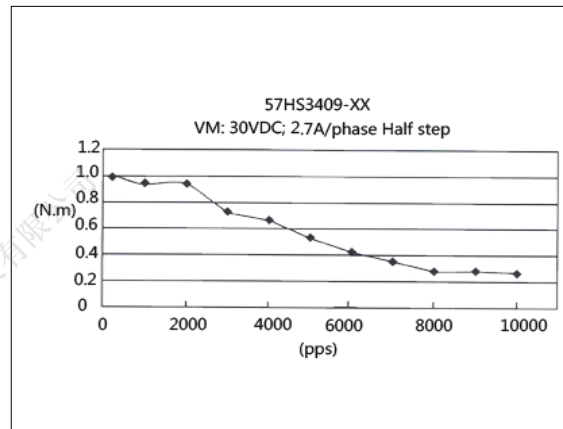
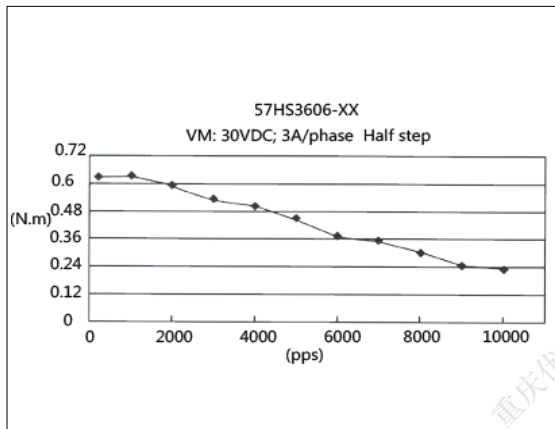
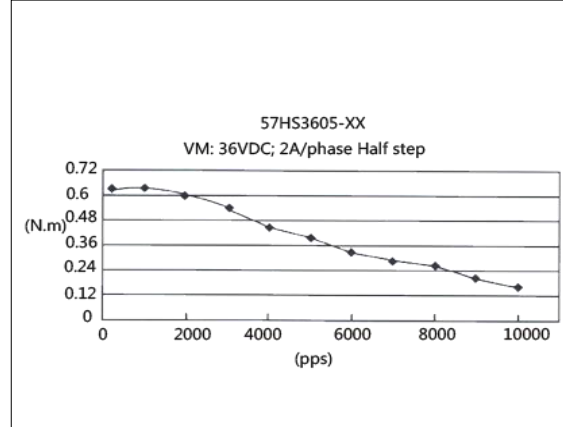
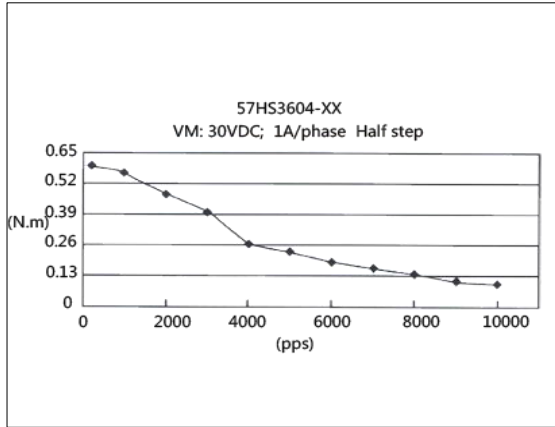

1.8°57mm

混合式步进电机参数 Hybrid Stepper Motor

力矩曲线 Torque Curve

