

$V_{RSM}$	=	5500 V
$I_{F(AV)M}$	=	3480 A
$I_{F(RMS)}$	=	5470 A
$I_{FSM}$	=	$46 \times 10^3$ A
$V_{F0}$	=	0.94 V
$r_F$	=	0.147 mW

# Rectifier Diode

## 5SDD 33L5500

Doc. No. 5SYA1168-00 March 05

- Patented free-floating silicon technology
- Very low on-state losses
- Optimum power handling capability

### Blocking

*Maximum rated values*<sup>1)</sup>

Parameter	Symbol	Conditions	Value	Unit
Repetitive peak reverse voltage	$V_{RRM}$	$f = 50$ Hz, $t_p = 10$ ms, $T_j = 0 \dots 150^\circ\text{C}$	5000	V
Non-repetitive peak reverse voltage	$V_{RSM}$	$f = 5$ Hz, $t_p = 10$ ms, $T_j = 0 \dots 150^\circ\text{C}$	5500	V

*Characteristic values*

Parameter	Symbol	Conditions	min	typ	max	Unit
Max. (reverse) leakage current	$I_{RRM}$	$V_{RRM}$ , $T_j = 150^\circ\text{C}$			400	mA

### Mechanical data

*Maximum rated values*<sup>1)</sup>

Parameter	Symbol	Conditions	min	typ	max	Unit
Mounting force	$F_M$		63	70	77	kN
Acceleration	a	Device unclamped			50	$\text{m/s}^2$
Acceleration	a	Device clamped			100	$\text{m/s}^2$

*Characteristic values*

Parameter	Symbol	Conditions	min	typ	max	Unit
Weight	m				1.45	kg
Housing thickness	H	$F_M = 70$ kN, $T_a = 25^\circ\text{C}$	26.0		26.6	mm
Surface creepage distance	$D_S$		35			mm
Air strike distance	$D_a$		14			mm

1) Maximum rated values indicate limits beyond which damage to the device may occur

ABB Switzerland Ltd, Semiconductors reserves the right to change specifications without notice.

## On-state

Maximum rated values <sup>1)</sup>

Parameter	Symbol	Conditions	min	typ	max	Unit
Max. average on-state current	$I_{F(AV)M}$	50 Hz, Half sine wave, $T_C = 90\text{ °C}$			3480	A
Max. RMS on-state current	$I_{F(RMS)}$				5470	A
Max. peak non-repetitive surge current	$I_{FSM}$	$t_p = 10\text{ ms}$ , $T_j = 150\text{ °C}$ , $V_R = 0\text{ V}$			$46 \times 10^3$	A
Limiting load integral	$I^2t$				$10.6 \times 10^6$	$A^2s$
Max. peak non-repetitive surge current	$I_{FSM}$	$t_p = 8.3\text{ ms}$ , $T_j = 150\text{ °C}$ , $V_R = 0\text{ V}$			$49.2 \times 10^3$	A
Limiting load integral	$I^2t$				$10.06 \times 10^6$	$A^2s$

### Characteristic values

Parameter	Symbol	Conditions	min	typ	max	Unit
On-state voltage	$V_F$	$I_F = 5000\text{ A}$ , $T_j = 150\text{ °C}$			1.68	V
Threshold voltage	$V_{(T0)}$	$T_j = 150\text{ °C}$			0.94	V
Slope resistance	$r_T$	$I_T = 3000 \dots 8000\text{ A}$			0.147	$m\Omega$

## Switching

Characteristic values

Parameter	Symbol	Conditions	min	typ	max	Unit
Recovery charge	$Q_{rr}$	$di_F/dt = -10\text{ A}/\mu s$ , $V_R = 200\text{ V}$ $I_{FRM} = 4000\text{ A}$ , $T_j = 150\text{ °C}$			10000	$\mu As$

# Thermal

Maximum rated values <sup>1)</sup>

Parameter	Symbol	Conditions	min	typ	max	Unit
Operating junction temperature range	T <sub>vj</sub>		0		150	°C
Storage temperature range	T <sub>stg</sub>		-40		150	°C

## Characteristic values

Parameter	Symbol	Conditions	min	typ	max	Unit
Thermal resistance junction to case	R <sub>th(j-c)</sub>	Double-side cooled F <sub>m</sub> = 63...77 kN			7	K/kW
	R <sub>th(j-c)A</sub>	Anode-side cooled F <sub>m</sub> = 63...77 kN			14	K/kW
	R <sub>th(j-c)C</sub>	Cathode-side cooled F <sub>m</sub> = 63...77 kN			14	K/kW
Thermal resistance case to heatsink	R <sub>th(c-h)</sub>	Double-side cooled F <sub>m</sub> = 63...77 kN			1.5	K/kW
	R <sub>th(c-h)</sub>	Single-side cooled F <sub>m</sub> = 63...77 kN			3	K/kW

Analytical function for transient thermal impedance:

$$Z_{th(j-c)}(t) = \sum_{i=1}^n R_{th i} (1 - e^{-t/t_i})$$

i	1	2	3	4
R <sub>th i</sub> (K/kW)	4.701	1.401	0.611	0.298
τ <sub>i</sub> (s)	0.5463	0.0746	0.0087	0.0021

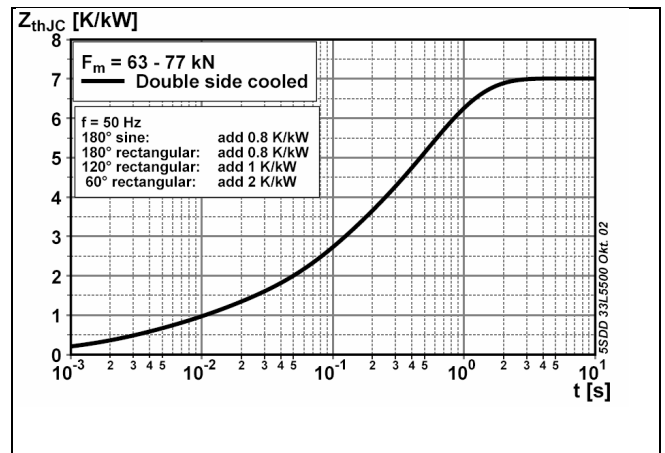

Fig. 1 Transient thermal impedance junction-to-case.

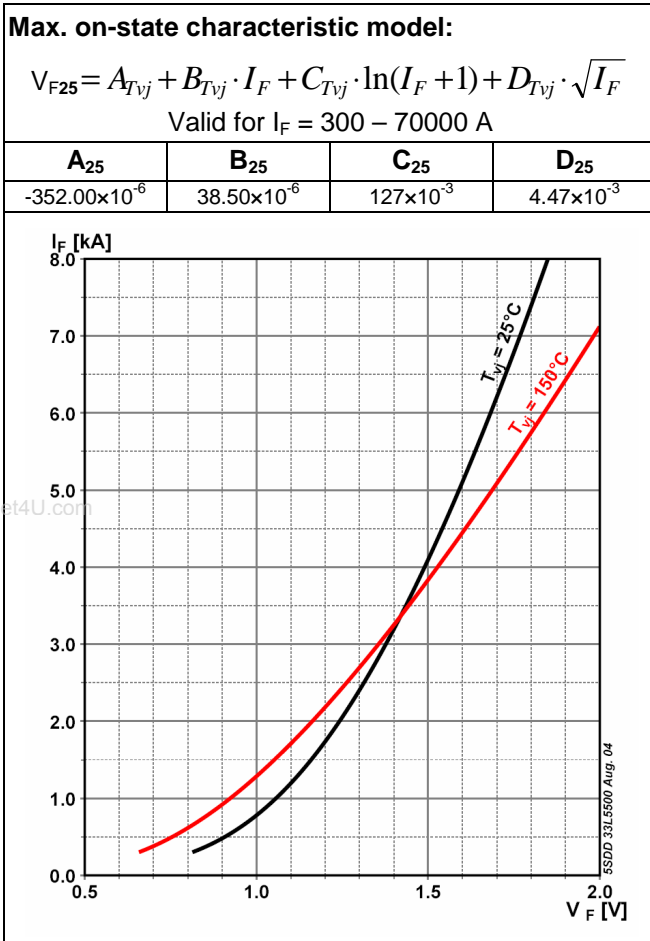

Fig. 2 Isothermal on-state characteristics

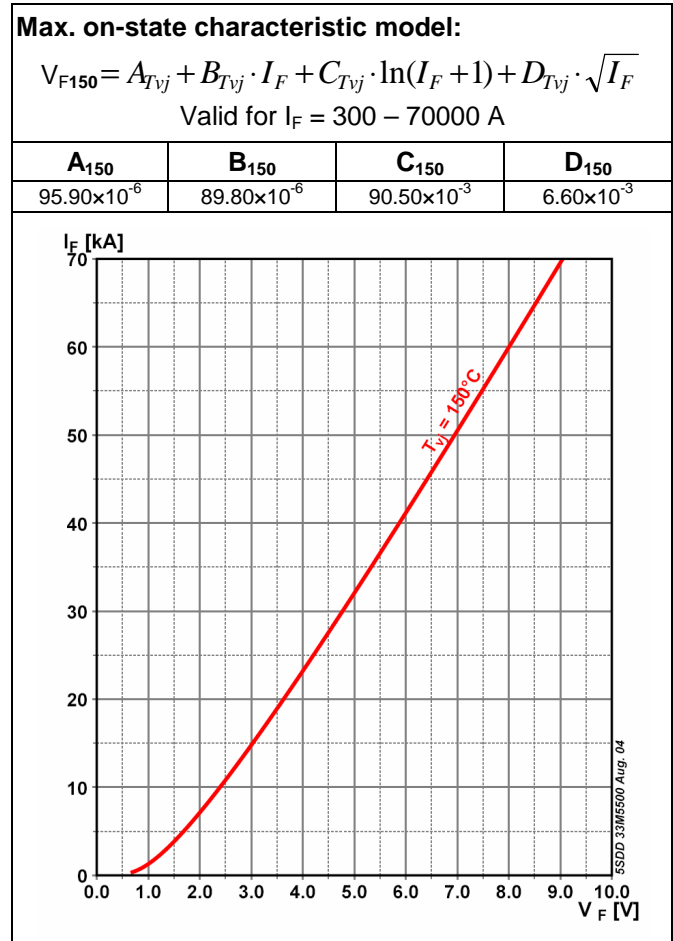

Fig. 3 Isothermal on-state characteristics

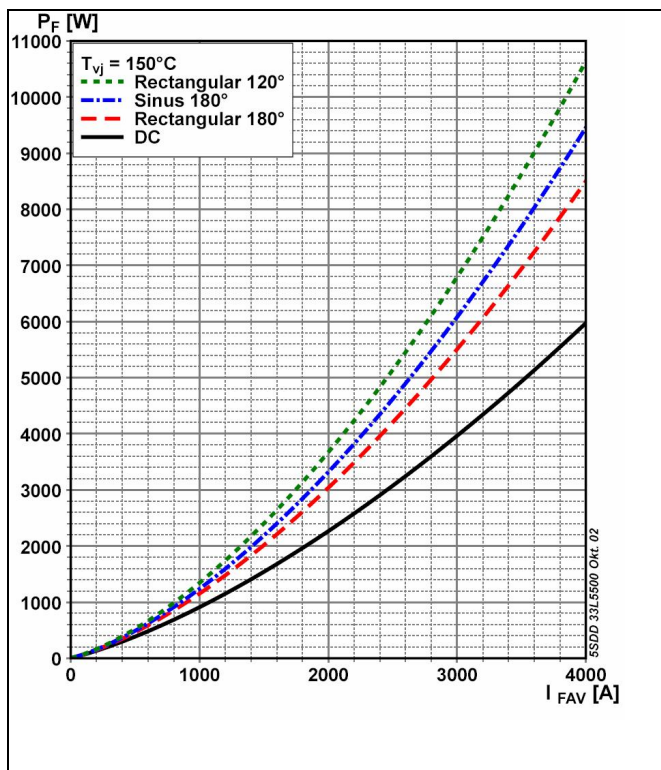

Fig. 4 On-state power losses vs average on-state current.

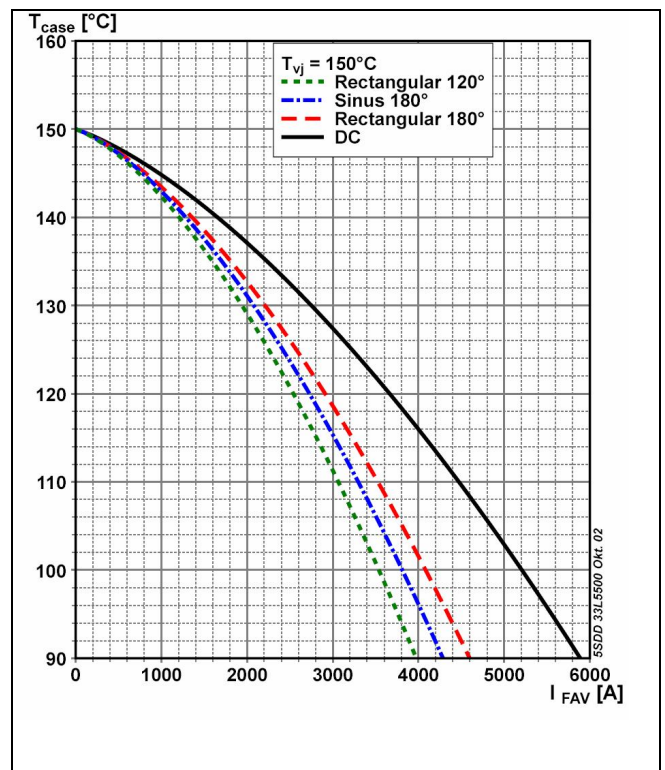

Fig. 5 Max. permissible case temperature vs average on-state current.

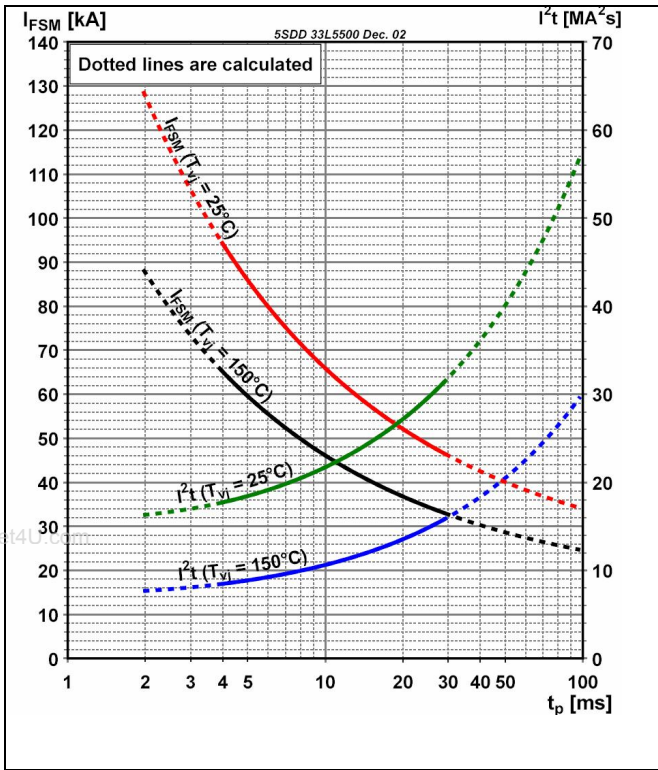

Fig. 6 Surge on-state current vs. number of pulses. Half-sine wave, 10 ms, 50Hz.

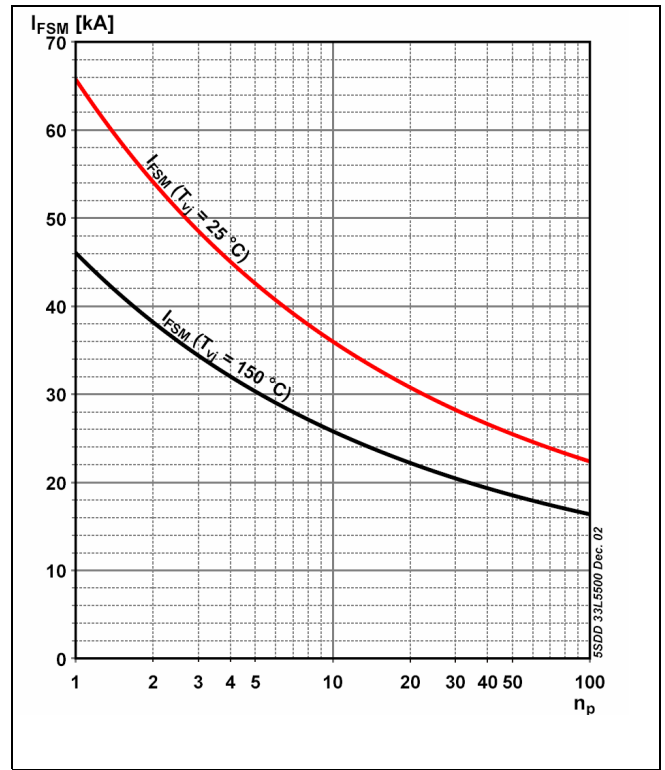

Fig. 7 Surge on-state current vs. number of pulses. Half-sine wave, 10 ms, 50Hz.

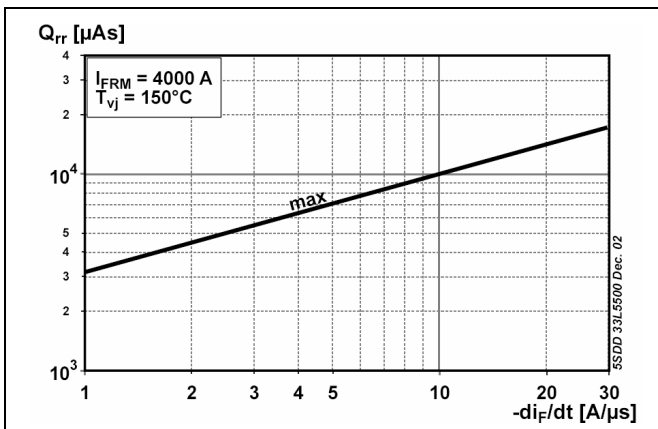

Fig. 8 Recovery charge vs. decay rate of on-state current.

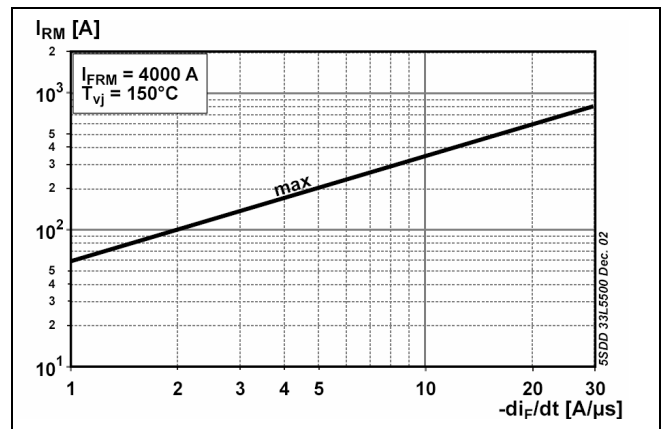
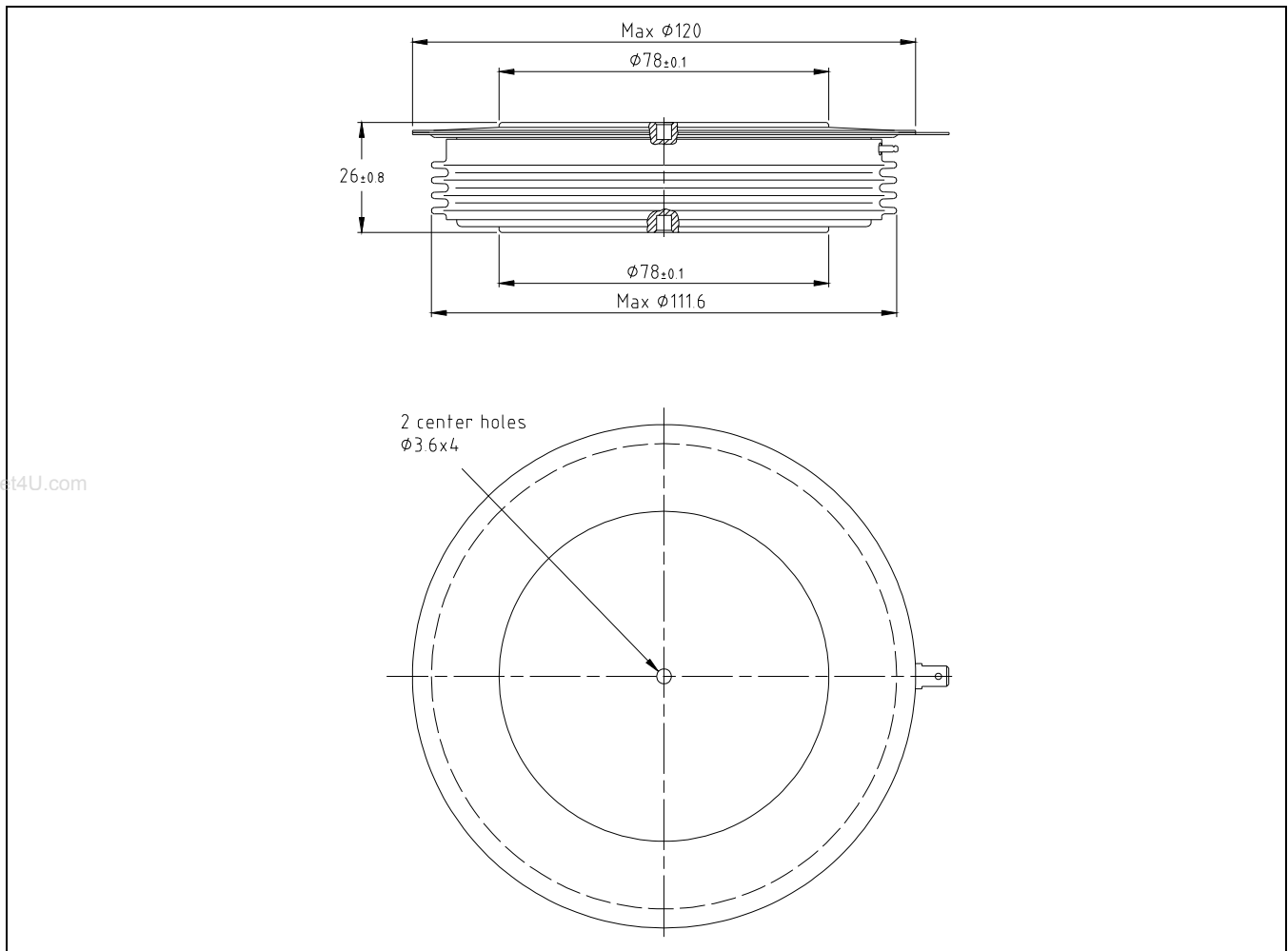

Fig. 9 Peak reverse recovery current vs. decay rate of on-state current.



**Fig. 10** Outline drawing. All dimensions are in millimeters and represent nominal values unless stated otherwise.

### Related application notes:

Doc. Nr	Titel
5SYA 2020	Design of RC-Snubbers for Phase Control Applications
5SYA 2029	Designing Large Rectifiers with High Power Diodes
5SYA 2036	Recommendations regarding mechanical clamping of Press Pack High Power Semiconductors

Please refer to <http://www.abb.com/semiconductors> for actual versions.

**ABB Switzerland Ltd, Semiconductors reserves the right to change specifications without notice.**

# ABB

**ABB Switzerland Ltd**  
**Semiconductors**  
 Fabrikstrasse 3  
 CH-5600 Lenzburg, Switzerland

Telephone +41 (0)58 586 1419  
 Fax +41 (0)58 586 1306  
 Email [abbsem@ch.abb.com](mailto:abbsem@ch.abb.com)  
 Internet [www.abb.com/semiconductors](http://www.abb.com/semiconductors)

Doc. No. 5SYA1168-00 March 05

[www.DataSheet4U.com](http://www.DataSheet4U.com)