

$V_{CE} = 6500 \text{ V}$
 $I_C = 400 \text{ A}$

ABB HiPak™

IGBT Module
5SNA 0400J650100

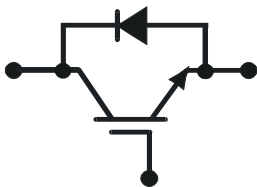

Doc. No. 5SYA 1592-01 Jun 07

- Low-loss, rugged SPT chip-set
- Smooth switching SPT chip-set for good EMC
- High insulation package
- AISiC base-plate for high power cycling capability
- AlN substrate for low thermal resistance



Maximum rated values ¹⁾

| Parameter | Symbol | Conditions | min | max | Unit |
|--------------------------------|--------------|--|-----|-------|--------------------|
| Collector-emitter voltage | V_{CES} | $V_{GE} = 0 \text{ V}, T_{vj} \geq 25 \text{ °C}$ | | 6500 | V |
| DC collector current | I_C | $T_c = 85 \text{ °C}$ | | 400 | A |
| Peak collector current | I_{CM} | $t_p = 1 \text{ ms}, T_c = 85 \text{ °C}$ | | 800 | A |
| Gate-emitter voltage | V_{GES} | | -20 | 20 | V |
| Total power dissipation | P_{tot} | $T_c = 25 \text{ °C}$, per switch (IGBT) | | 7350 | W |
| DC forward current | I_F | | | 400 | A |
| Peak forward current | I_{FRM} | | | 800 | A |
| Surge current | I_{FSM} | $V_R = 0 \text{ V}, T_{vj} = 125 \text{ °C}$, $t_p = 10 \text{ ms}$, half-sinewave | | 4000 | A |
| IGBT short circuit SOA | t_{psc} | $V_{CC} = 4400 \text{ V}, V_{CEMCHIP} \leq 6500 \text{ V}$ $V_{GE} \leq 15 \text{ V}, T_{vj} \leq 125 \text{ °C}$ | | 10 | μs |
| Isolation voltage | V_{isol} | 1 min, $f = 50 \text{ Hz}$ | | 10200 | V |
| Junction temperature | T_{vj} | | | 125 | $^{\circ}\text{C}$ |
| Junction operating temperature | $T_{vj(op)}$ | | -40 | 125 | $^{\circ}\text{C}$ |
| Case temperature | T_c | | -40 | 125 | $^{\circ}\text{C}$ |
| Storage temperature | T_{stg} | | -40 | 125 | $^{\circ}\text{C}$ |
| Mounting torques ²⁾ | M_s | Base-heatsink, M6 screws | 4 | 6 | Nm |
| | M_{t1} | Main terminals, M8 screws | 8 | 10 | |
| | M_{t2} | Auxiliary terminals, M4 screws | 2 | 3 | |

¹⁾ Maximum rated values indicate limits beyond which damage to the device may occur per IEC 60747

²⁾ For detailed mounting instructions refer to ABB Document No. 5SYA2039

ABB Switzerland Ltd, Semiconductors reserves the right to change specifications without notice.



IGBT characteristic values ³⁾

| Parameter | Symbol | Conditions | min | typ | max | Unit |
|--|-------------------------|---|---------------------------|------|-----|---------------|
| Collector (-emitter) breakdown voltage | $V_{(BR)CES}$ | $V_{GE} = 0 \text{ V}$, $I_C = 10 \text{ mA}$, $T_{vj} = 25 \text{ °C}$ | 6500 | | | V |
| Collector-emitter ⁴⁾ saturation voltage | $V_{CE \text{ sat}}$ | $I_C = 400 \text{ A}$, $V_{GE} = 15 \text{ V}$ | | 4.2 | 4.8 | V |
| | | $T_{vj} = 25 \text{ °C}$ | | | | |
| | | $T_{vj} = 125 \text{ °C}$ | | 5.4 | 5.9 | V |
| Collector cut-off current | I_{CES} | $V_{CE} = 6500 \text{ V}$, $V_{GE} = 0 \text{ V}$ | | | 8 | mA |
| | | $T_{vj} = 25 \text{ °C}$ | | | | |
| | | $T_{vj} = 125 \text{ °C}$ | | 35 | 80 | mA |
| Gate leakage current | I_{GES} | $V_{CE} = 0 \text{ V}$, $V_{GE} = \pm 20 \text{ V}$, $T_{vj} = 125 \text{ °C}$ | -500 | | 500 | nA |
| Gate-emitter threshold voltage | $V_{GE(TO)}$ | $I_C = 160 \text{ mA}$, $V_{CE} = V_{GE}$, $T_{vj} = 25 \text{ °C}$ | 6 | 7.4 | 8 | V |
| Gate charge | Q_{ge} | $I_C = 400 \text{ A}$, $V_{CE} = 3600 \text{ V}$, $V_{GE} = -15 \text{ V} \dots 15 \text{ V}$ | | 5.3 | | μC |
| Input capacitance | C_{ies} | $V_{CE} = 25 \text{ V}$, $V_{GE} = 0 \text{ V}$, $f = 1 \text{ MHz}$, $T_{vj} = 25 \text{ °C}$ | | 95.3 | | nF |
| Output capacitance | C_{oes} | | | 4.41 | | |
| Reverse transfer capacitance | C_{res} | | | 0.85 | | |
| Turn-on delay time | $t_{d(on)}$ | $V_{CC} = 3600 \text{ V}$, $I_C = 400 \text{ A}$, $R_G = 5.6 \text{ }\Omega$, | $T_{vj} = 25 \text{ °C}$ | 700 | | ns |
| | | | $T_{vj} = 125 \text{ °C}$ | 630 | | |
| Rise time | t_r | $V_{GE} = \pm 15 \text{ V}$, $L_\sigma = 280 \text{ nH}$, inductive load | $T_{vj} = 25 \text{ °C}$ | 250 | | ns |
| | | | $T_{vj} = 125 \text{ °C}$ | 220 | | |
| Turn-off delay time | $t_{d(off)}$ | $V_{CC} = 3600 \text{ V}$, $I_C = 400 \text{ A}$, $R_G = 5.6 \text{ }\Omega$, | $T_{vj} = 25 \text{ °C}$ | 1410 | | ns |
| | | | $T_{vj} = 125 \text{ °C}$ | 1700 | | |
| Fall time | t_f | $V_{GE} = \pm 15 \text{ V}$, $L_\sigma = 280 \text{ nH}$, inductive load | $T_{vj} = 25 \text{ °C}$ | 650 | | ns |
| | | | $T_{vj} = 125 \text{ °C}$ | 980 | | |
| Turn-on switching energy | E_{on} | $V_{CC} = 3600 \text{ V}$, $I_C = 400 \text{ A}$, $V_{GE} = \pm 15 \text{ V}$, $R_G = 5.6 \text{ }\Omega$, $L_\sigma = 280 \text{ nH}$, inductive load | $T_{vj} = 25 \text{ °C}$ | 2250 | | mJ |
| | | | $T_{vj} = 125 \text{ °C}$ | 2800 | | |
| Turn-off switching energy | E_{off} | $V_{CC} = 3600 \text{ V}$, $I_C = 400 \text{ A}$, $V_{GE} = \pm 15 \text{ V}$, $R_G = 5.6 \text{ }\Omega$, $L_\sigma = 280 \text{ nH}$, inductive load | $T_{vj} = 25 \text{ °C}$ | 1340 | | mJ |
| | | | $T_{vj} = 125 \text{ °C}$ | 2120 | | |
| Short circuit current | I_{SC} | $t_{psc} \leq 10 \text{ }\mu\text{s}$, $V_{GE} = 15 \text{ V}$, $T_{vj} = 125 \text{ °C}$, $V_{CC} = 4400 \text{ V}$, $V_{CEM \text{ CHIP}} \leq 6500 \text{ V}$ | | 1800 | | A |
| Module stray inductance | $L_{\sigma \text{ CE}}$ | | | 20 | | nH |
| Resistance, terminal-chip | $R_{CC'+EE'}$ | | $T_C = 25 \text{ °C}$ | 0.1 | | m Ω |
| | | | $T_C = 125 \text{ °C}$ | 0.15 | | |

³⁾ Characteristic values according to IEC 60747 – 9⁴⁾ Collector-emitter saturation voltage is given at chip level

Diode characteristic values⁵⁾

| Parameter | Symbol | Conditions | min | typ | max | Unit |
|-------------------------------|-----------|--|---------------------------|------|-----|---------------|
| Forward voltage ⁶⁾ | V_F | $I_F = 400 \text{ A}$ | $T_{vj} = 25 \text{ °C}$ | 3.2 | 3.8 | V |
| | | | $T_{vj} = 125 \text{ °C}$ | 3.4 | 4.0 | |
| Reverse recovery current | I_{rr} | $V_{CC} = 3600 \text{ V},$ $I_F = 400 \text{ A},$ $V_{GE} = \pm 15 \text{ V},$ $R_G = 5.6 \text{ } \Omega$ $L_\sigma = 280 \text{ nH}$ inductive load | $T_{vj} = 25 \text{ °C}$ | 510 | | A |
| | | | $T_{vj} = 125 \text{ °C}$ | 680 | | |
| Recovered charge | Q_{rr} | $V_{CC} = 3600 \text{ V},$ $I_F = 400 \text{ A},$ $V_{GE} = \pm 15 \text{ V},$ $R_G = 5.6 \text{ } \Omega$ $L_\sigma = 280 \text{ nH}$ inductive load | $T_{vj} = 25 \text{ °C}$ | 450 | | μC |
| | | | $T_{vj} = 125 \text{ °C}$ | 770 | | |
| Reverse recovery time | t_{rr} | $V_{CC} = 3600 \text{ V},$ $I_F = 400 \text{ A},$ $V_{GE} = \pm 15 \text{ V},$ $R_G = 5.6 \text{ } \Omega$ $L_\sigma = 280 \text{ nH}$ inductive load | $T_{vj} = 25 \text{ °C}$ | 1840 | | ns |
| | | | $T_{vj} = 125 \text{ °C}$ | 2120 | | |
| Reverse recovery energy | E_{rec} | $V_{CC} = 3600 \text{ V},$ $I_F = 400 \text{ A},$ $V_{GE} = \pm 15 \text{ V},$ $R_G = 5.6 \text{ } \Omega$ $L_\sigma = 280 \text{ nH}$ inductive load | $T_{vj} = 25 \text{ °C}$ | 670 | | mJ |
| | | | $T_{vj} = 125 \text{ °C}$ | 1380 | | |

⁵⁾ Characteristic values according to IEC 60747 – 2

⁶⁾ Forward voltage is given at chip level

Package properties⁷⁾

| Parameter | Symbol | Conditions | min | typ | max | Unit |
|---|--------------------|--|------|------------|-------|------|
| IGBT thermal resistance junction to case | $R_{th(j-c)IGBT}$ | | | | 0.016 | K/W |
| Diode thermal resistance junction to case | $R_{th(j-c)DIODE}$ | | | | 0.032 | K/W |
| IGBT thermal resistance ²⁾ case to heatsink | $R_{th(c-s)IGBT}$ | IGBT per switch, λ grease = $1\text{W/m}^2 \text{ K}$ | | 0.012 | | K/W |
| Diode thermal resistance ⁷⁾ case to heatsink | $R_{th(c-s)DIODE}$ | Diode per switch, λ grease = $1\text{W/m}^2 \text{ K}$ | | 0.024 | | K/W |
| Partial discharge extinction voltage | V_e | $f = 50 \text{ Hz}, Q_{PD} \leq 10\text{pC}$ (acc. to IEC 61287) | 5100 | | | V |
| Comparative tracking index | CTI | | | ≥ 600 | | |

²⁾ For detailed mounting instructions refer to ABB Document No. 5SYA2039

Mechanical properties⁷⁾

| Parameter | Symbol | Conditions | min | typ | max | Unit |
|---------------------------|-----------------------|---|----------------|------|-----|------|
| Dimensions | $L \times W \times H$ | Typical, see outline drawing | 130 × 140 × 48 | | | mm |
| Clearance distance in air | d_a | according to IEC 60664-1 and EN 50124-1 | Term. to base: | 40 | | mm |
| | | | Term. to term: | 26 | | |
| Surface creepage distance | d_s | according to IEC 60664-1 and EN 50124-1 | Term. to base: | 64 | | mm |
| | | | Term. to term: | 56 | | |
| Mass | m | | | 1150 | | g |

⁷⁾ Package and mechanical properties according to IEC 60747 – 15

Electrical configuration

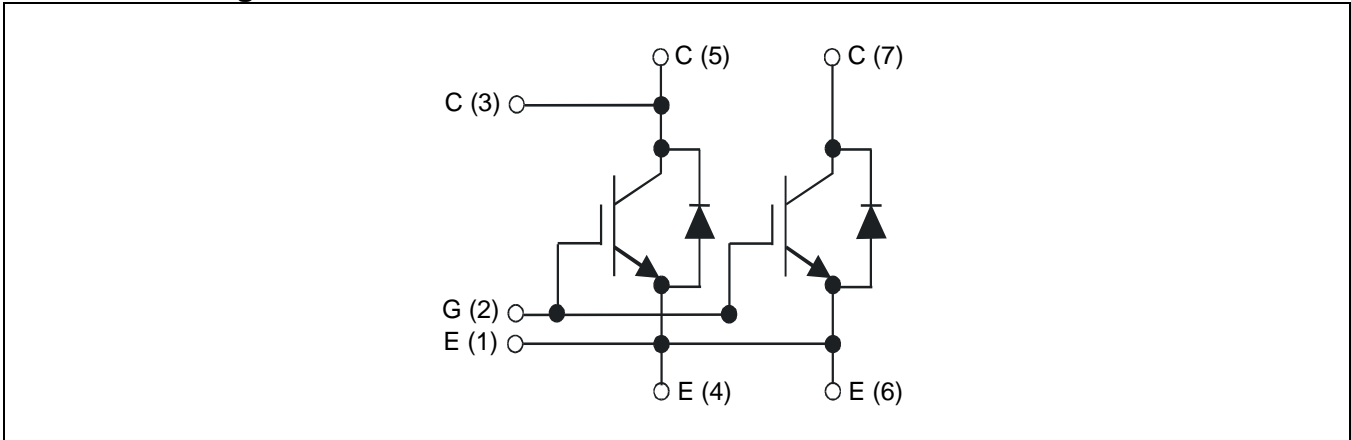

Outline drawing ²⁾

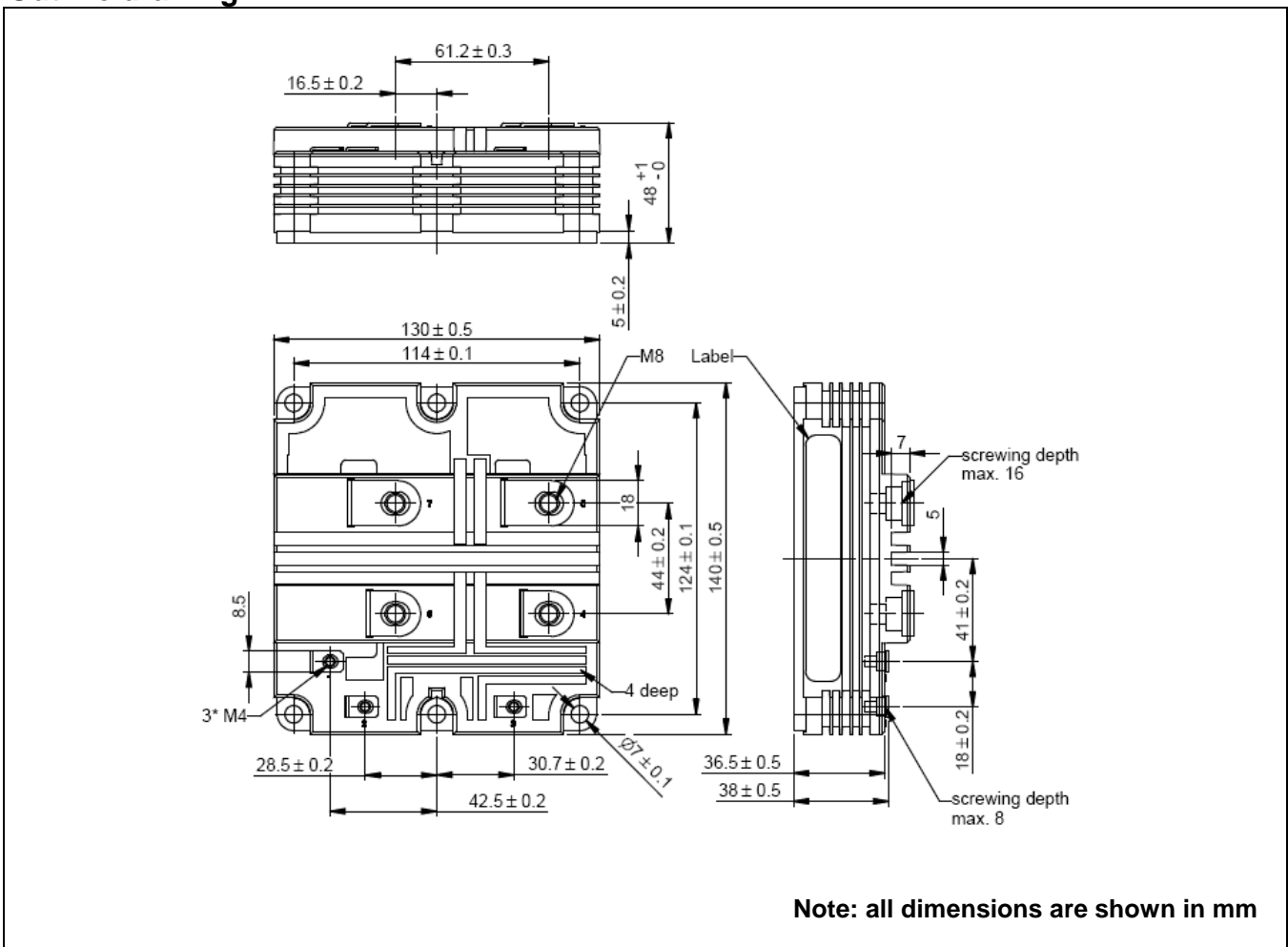

²⁾ For detailed mounting instructions refer to ABB Document No. 5SYA2039

This is an electrostatic sensitive device, please observe the international standard IEC 60747-1, chap. IX.

This product has been designed and qualified for Industrial Level.

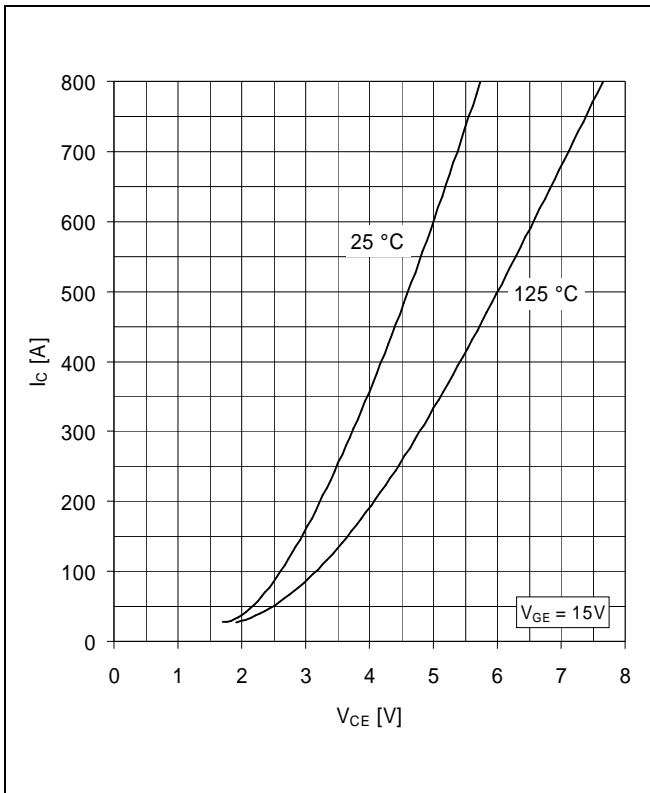

Fig. 1 Typical on-state characteristics, chip level

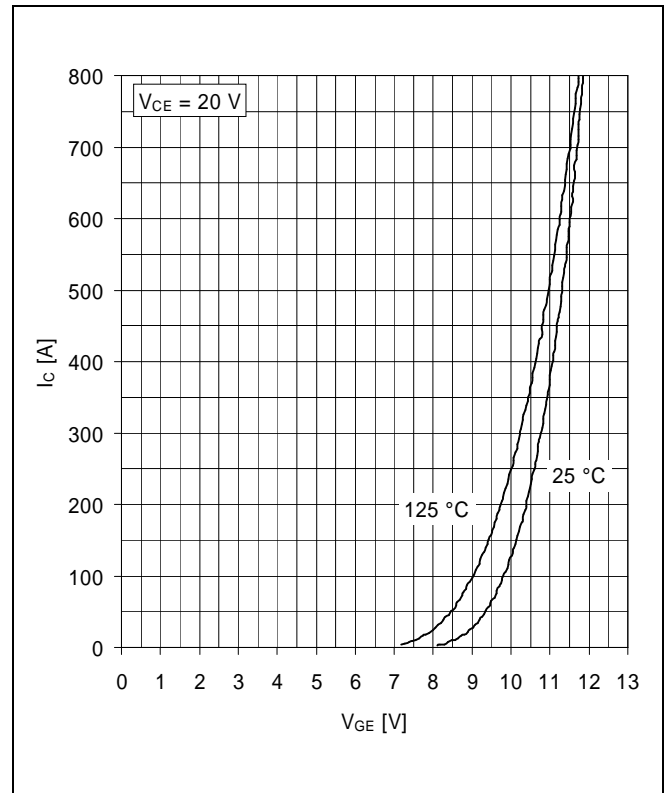

Fig. 2 Typical transfer characteristics, chip level

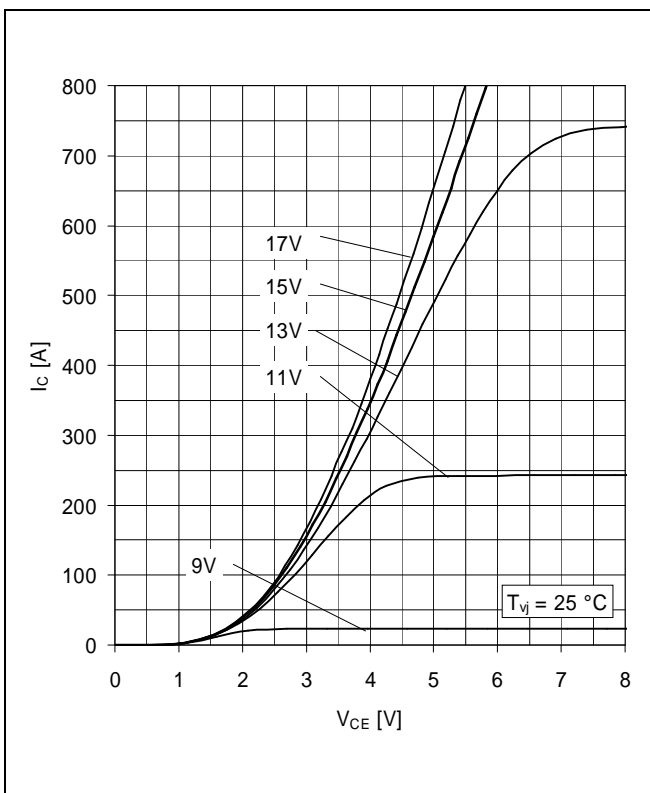

Fig. 3 Typical output characteristics, chip level

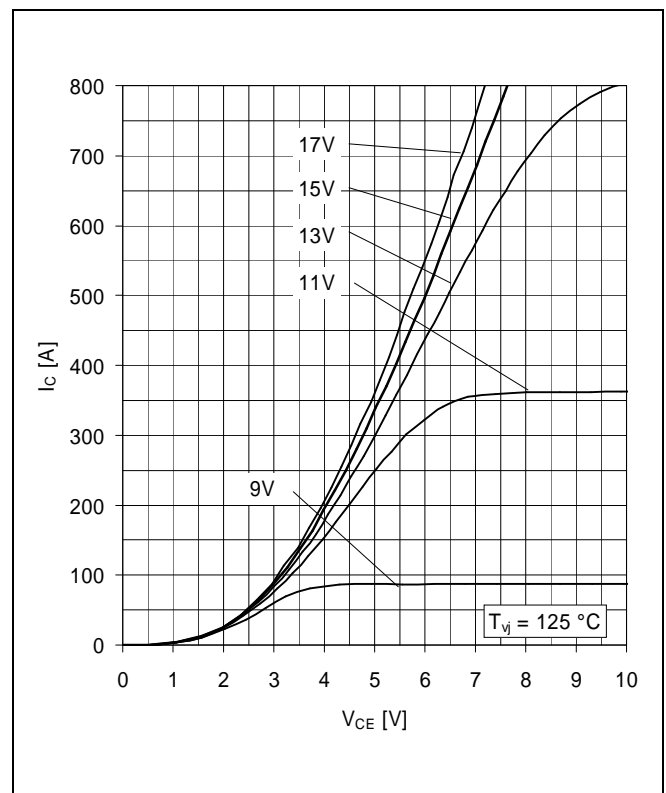

Fig. 4 Typical output characteristics, chip level

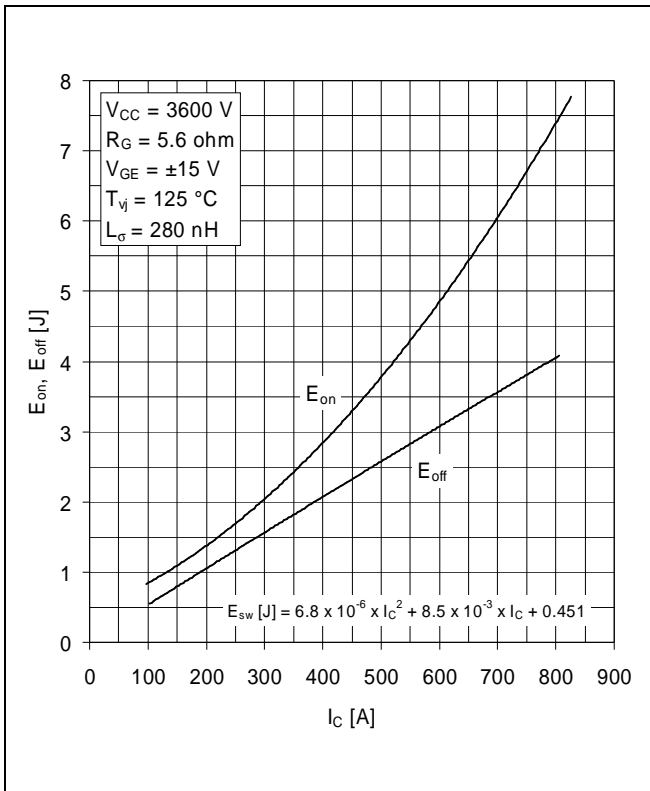

Fig. 5 Typical switching energies per pulse vs collector current

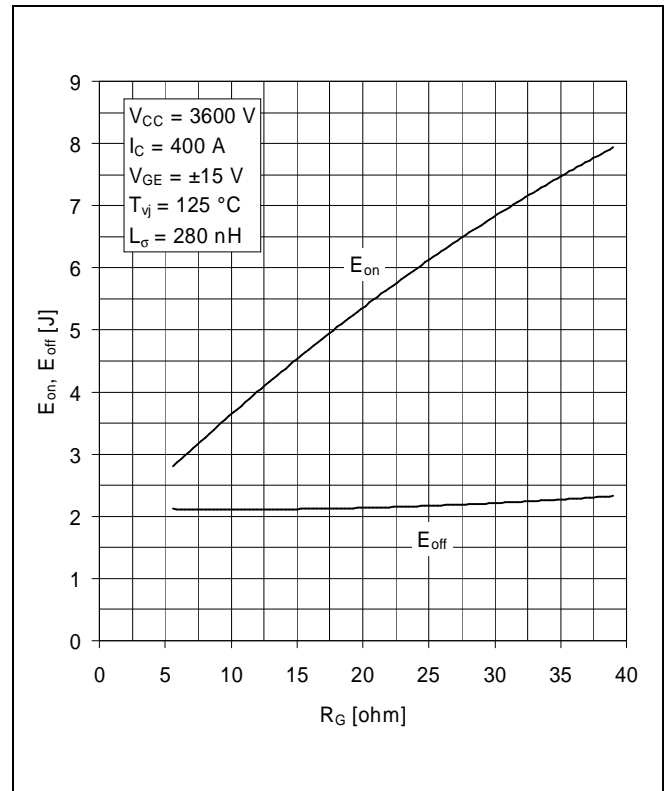

Fig. 6 Typical switching energies per pulse vs gate resistor

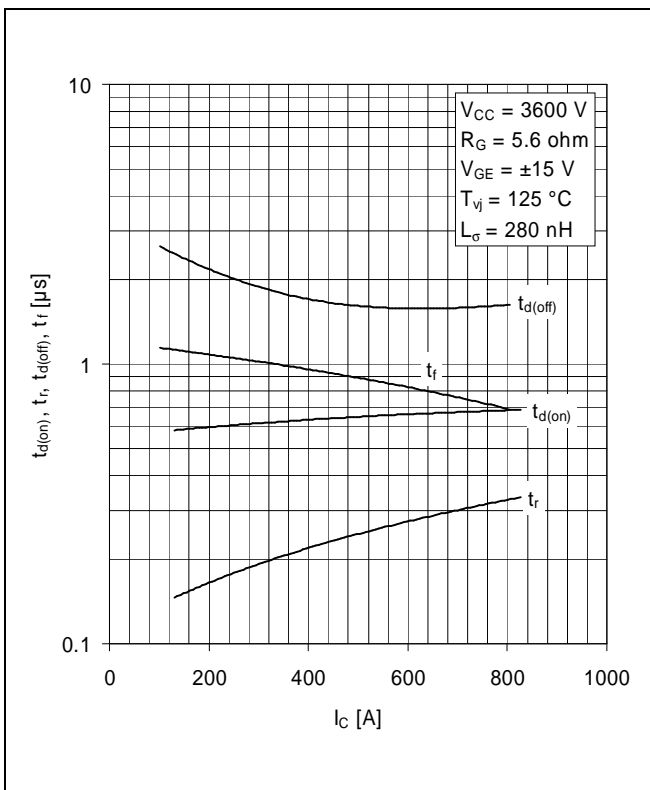

Fig. 7 Typical switching times vs collector current

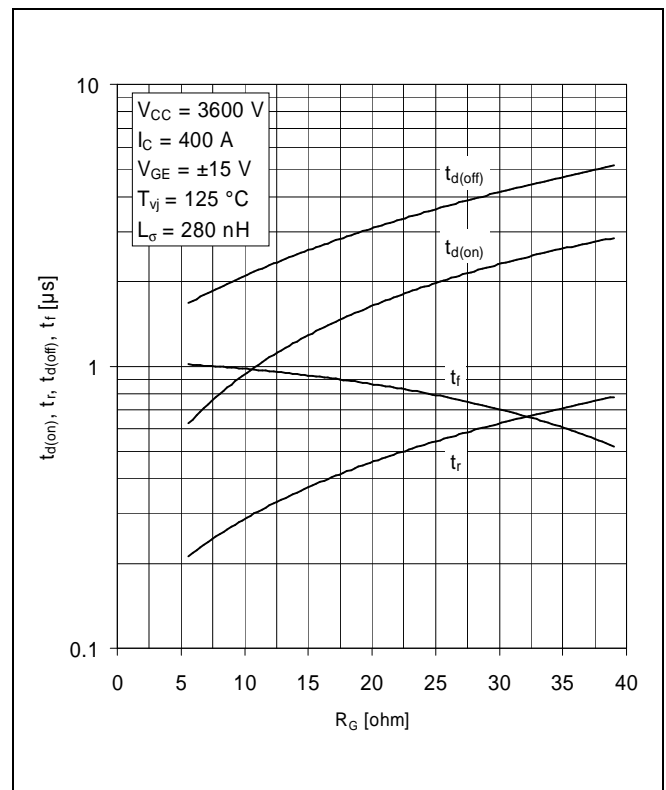

Fig. 8 Typical switching times vs gate resistor

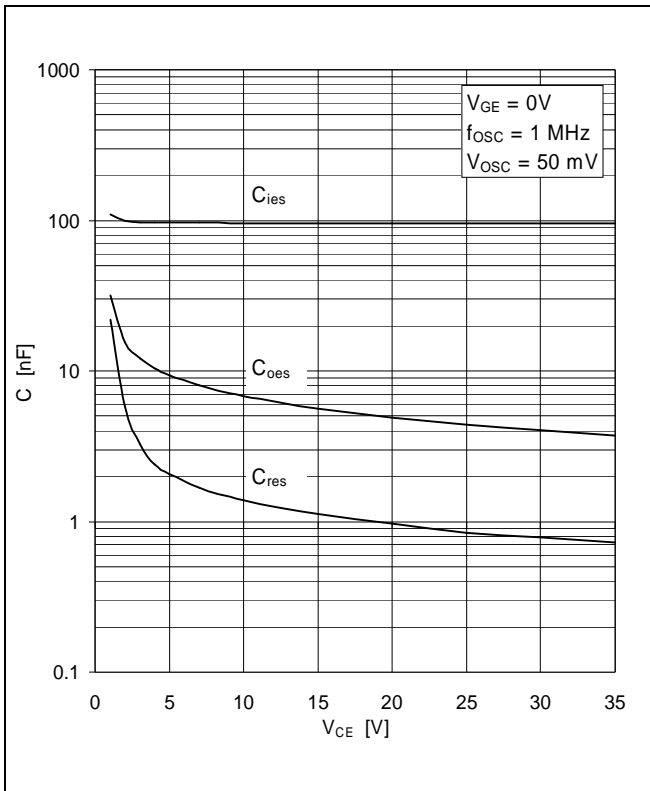

Fig. 9 Typical capacitances vs collector-emitter voltage

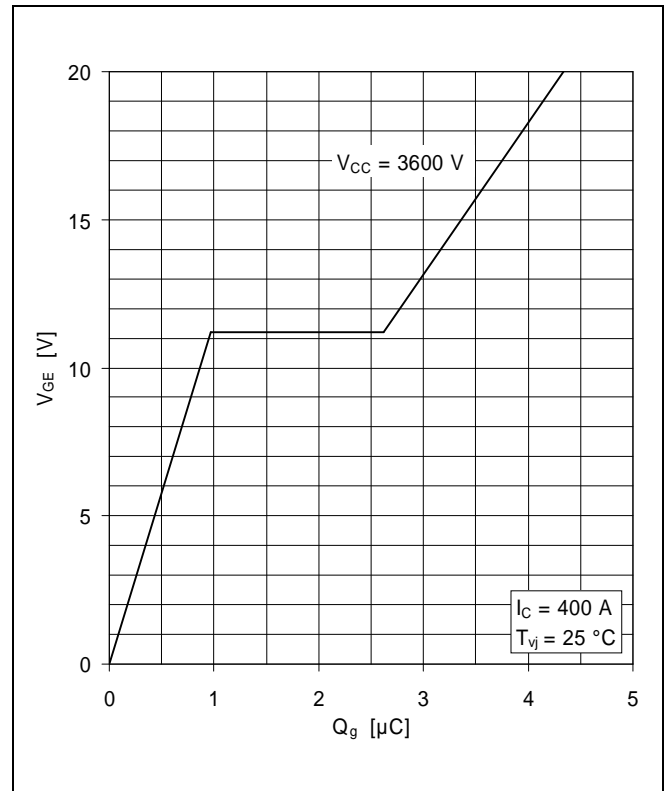

Fig. 10 Typical gate charge characteristics

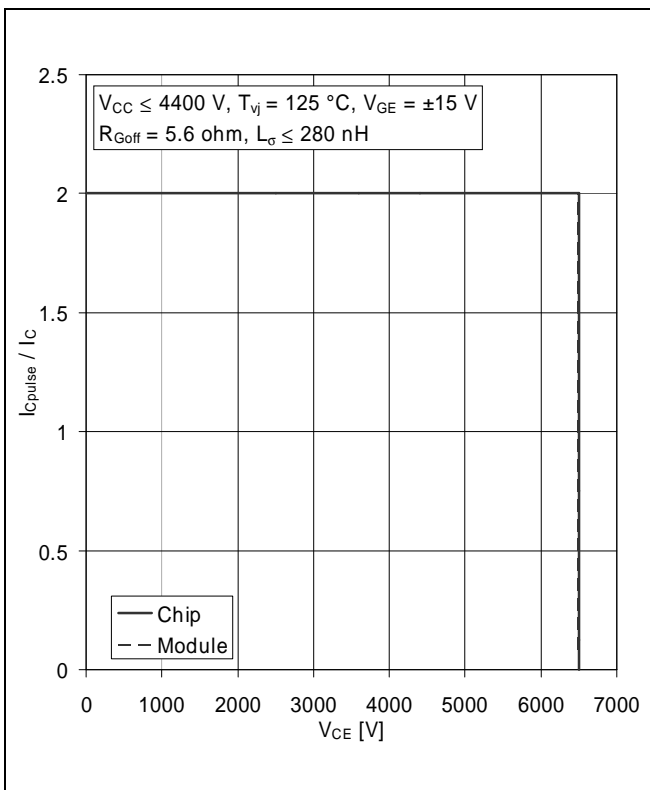

Fig. 11 Turn-off safe operating area (RBSOA)

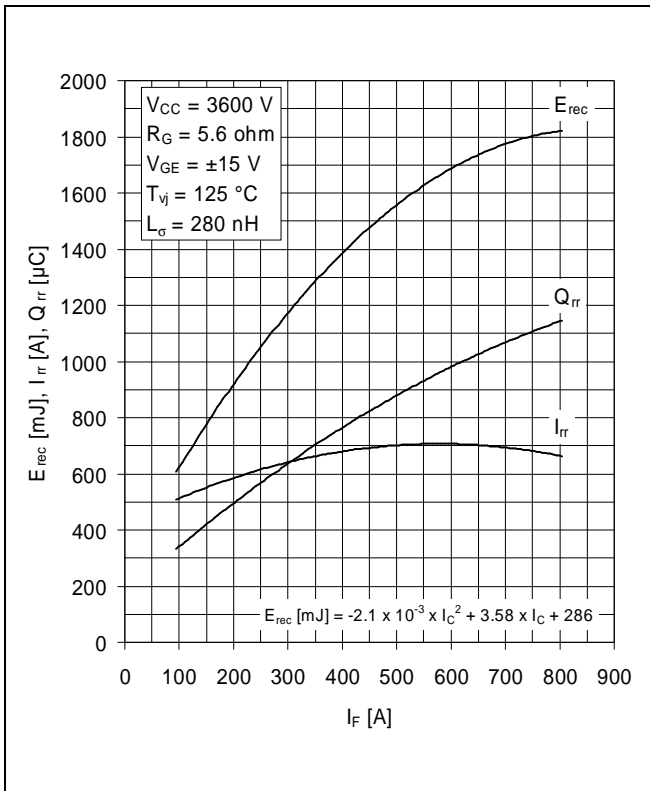

Fig. 12 Typical reverse recovery characteristics vs forward current

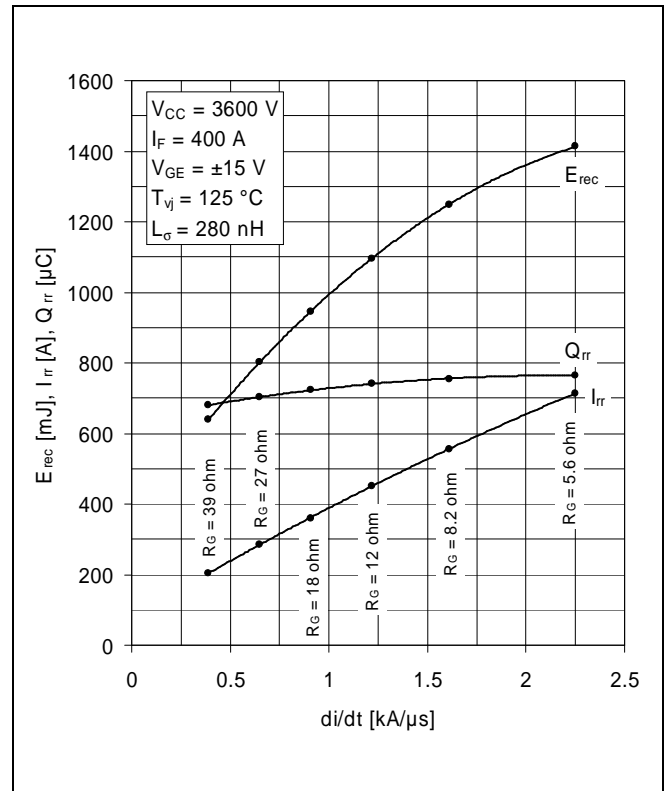

Fig. 13 Typical reverse recovery characteristics vs di/dt

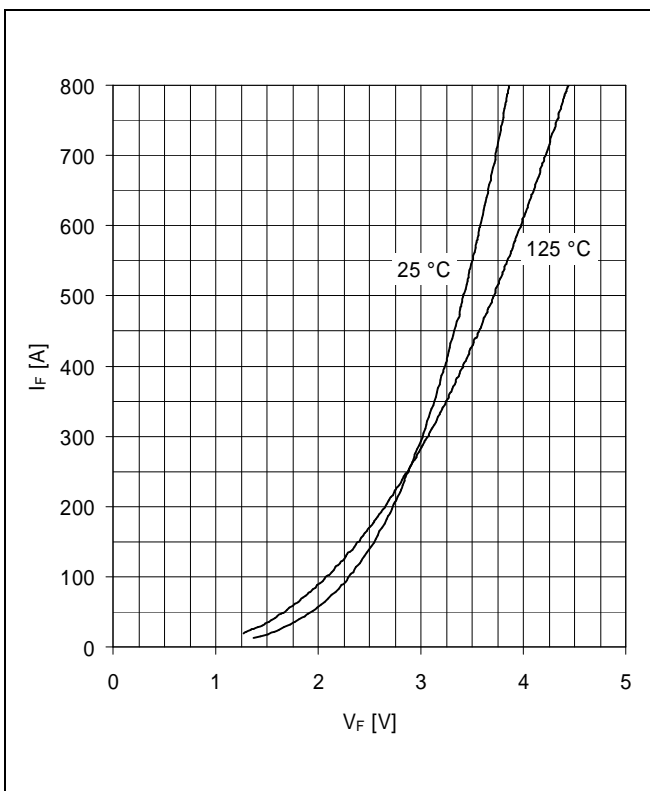

Fig. 14 Typical diode forward characteristics, chip level

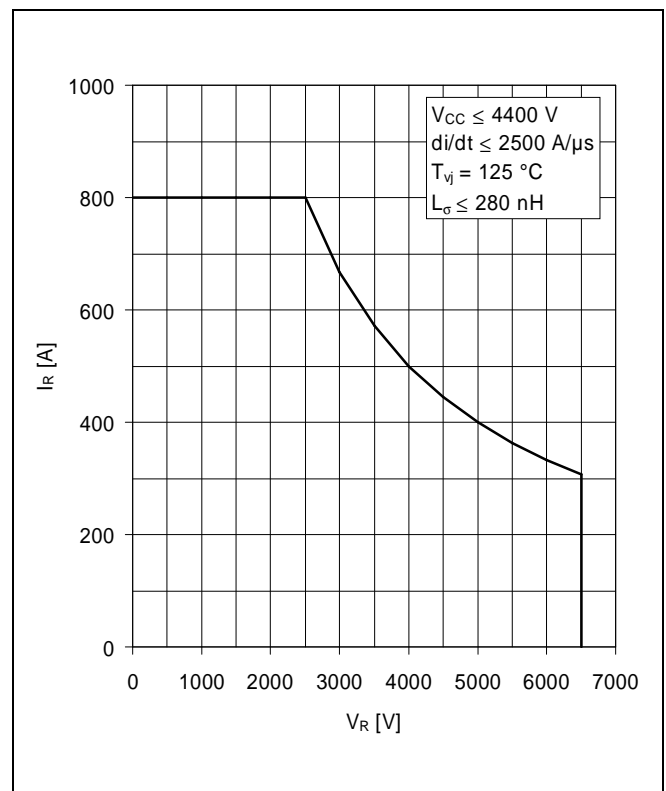

Fig. 15 Safe operating area diode (SOA)

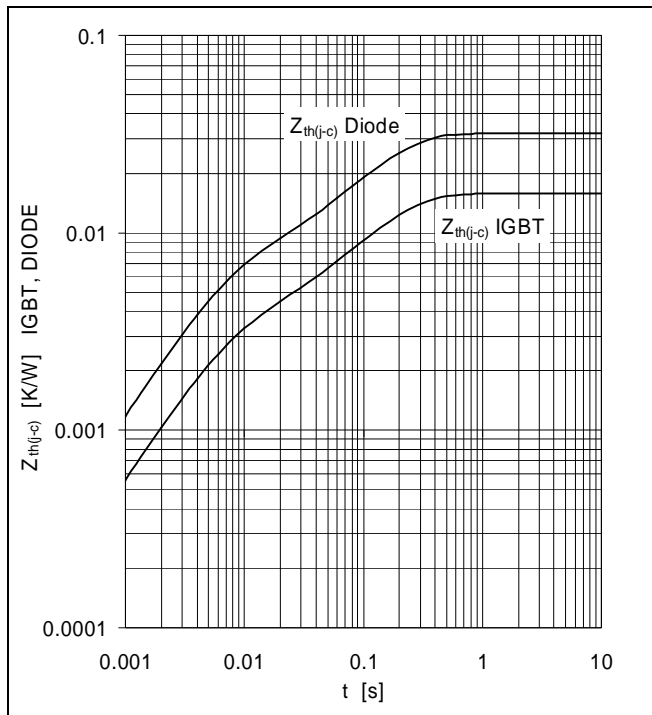

Fig. 16 Thermal impedance vs time

Analytical function for transient thermal impedance:

$$Z_{th(j-c)}(t) = \sum_{i=1}^n R_i (1 - e^{-t/\tau_i})$$

| | | | | | | |
|-------|---------------|-------|------|---|---|---|
| | i | 1 | 2 | 3 | 4 | 5 |
| IGBT | R_i (K/kW) | 12.75 | 2.99 | | | |
| | τ_i (ms) | 151 | 5.84 | | | |
| DIODE | R_i (K/kW) | 25.5 | 6.3 | | | |
| | τ_i (ms) | 144 | 5.83 | | | |

For detailed information refer to:

- 5SYA 2042-02 Failure rates of HiPak modules due to cosmic rays
- 5SYA 2043-01 Load – cycle capability of HiPaks
- 5SZK 9120-00 Specification of environmental class for HiPak

ABB Switzerland Ltd, Semiconductors reserves the right to change specifications without notice.



ABB Switzerland Ltd
Semiconductors
 Fabrikstrasse 3
 CH-5600 Lenzburg, Switzerland

Doc. No. 5SYA 1592-01 Jun 07

Telephone +41 (0)58 586 1419
 Fax +41 (0)58 586 1306
 Email abbsem@ch.abb.com
 Internet www.abb.com/semiconductors