

V_{DSM}	=	2800 V
I_{TAVM}	=	2625 A
I_{TRMS}	=	4120 A
I_{TSM}	=	43000 A
V_{T0}	=	0.85 V
r_T	=	0.160 m Ω

Phase Control Thyristor

5STP 24H2800

Doc. No. 5SYA1047-02 Sep. 01

- Patented free-floating silicon technology
- Low on-state and switching losses
- Designed for traction, energy and industrial applications
- Optimum power handling capability
- Interdigitated amplifying gate

Blocking

Part Number	5STP 24H2800	5STP 24H2600	5STP 24H2200	Conditions
V_{DRM} V_{RRM}	2800 V	2600 V	2200 V	$f = 50$ Hz, $t_p = 10$ ms
V_{RSM1}	3000 V	2800 V	2400 V	$t_p = 5$ ms, single pulse
I_{DRM}	≤ 300 mA			V_{DRM} $T_j = 125^\circ\text{C}$
I_{RRM}	≤ 300 mA			V_{RRM}
dV/dt_{crit}	1000 V/ μ s			Exp. to $0.67 \times V_{DRM}$, $T_j = 125^\circ\text{C}$

Mechanical data

F_M	Mounting force	nom.	50 kN
		min.	45 kN
		max.	60 kN
a	Acceleration		
	Device unclamped		50 m/s ²
	Device clamped		100 m/s ²
m	Weight		0.9 kg
D_S	Surface creepage distance		36 mm
D_a	Air strike distance		15 mm



ABB Semiconductors AG reserves the right to change specifications without notice.

On-state

I_{TAVM}	Max. average on-state current	2625 A	Half sine wave, $T_C = 70^\circ\text{C}$	
I_{TRMS}	Max. RMS on-state current	4120 A		
I_{TSM}	Max. peak non-repetitive	43000 A	$t_p = 10\text{ ms}$	$T_j = 125^\circ\text{C}$
	surge current	46000 A	$t_p = 8.3\text{ ms}$	After surge:
I^2t	Limiting load integral	9245 kA^2s	$t_p = 10\text{ ms}$	$V_D = V_R = 0\text{V}$
		8781 kA^2s	$t_p = 8.3\text{ ms}$	
V_T	On-state voltage	1.35 V	$I_T = 3000\text{ A}$	$T_j = 125^\circ\text{C}$
V_{T0}	Threshold voltage	0.85 V	$I_T = 1500 - 4500\text{ A}$	
r_T	Slope resistance	0.160 $\text{m}\Omega$		
I_H	Holding current	25-75 mA	$T_j = 25^\circ\text{C}$	
		15-60 mA	$T_j = 125^\circ\text{C}$	
I_L	Latching current	150- mA	$T_j = 25^\circ\text{C}$	
		50-200 mA	$T_j = 125^\circ\text{C}$	

Switching

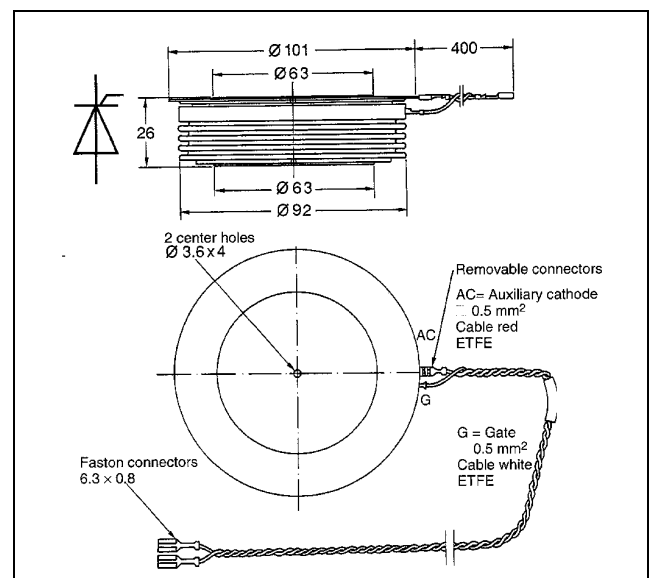
di/dt_{crit}	Critical rate of rise of on-state current	150 $\text{A}/\mu\text{s}$	Cont. $f = 50\text{ Hz}$	$V_D \leq 0.67 \cdot V_{DRM}$, $T_j = 125^\circ\text{C}$ $I_{TRM} = 3000\text{ A}$ $I_{FG} = 2\text{ A}$, $t_r = 0.5\ \mu\text{s}$
		300 $\text{A}/\mu\text{s}$	60 sec. $f = 50\text{ Hz}$	
t_d	Delay time	$\leq 3.0\ \mu\text{s}$	$V_D = 0.4 \cdot V_{DRM}$	$I_{FG} = 2\text{ A}$, $t_r = 0.5\ \mu\text{s}$
t_q	Turn-off time	$\leq 400\ \mu\text{s}$	$V_D \leq 0.67 \cdot V_{DRM}$ $dv_D/dt = 20\text{V}/\mu\text{s}$	$I_{TRM} = 3000\text{ A}$, $T_j = 125^\circ\text{C}$ $V_R > 200\text{ V}$, $di_T/dt = -20\text{ A}/\mu\text{s}$
Q_{rr}	Recovery charge	min	4000 μAs	
		max	7000 μAs	

Triggering

V_{GT}	Gate trigger voltage	2.6 V	$T_j = 25^\circ$
I_{GT}	Gate trigger current	400 mA	$T_j = 25^\circ$
V_{GD}	Gate non-trigger voltage	0.3 V	$V_D = 0.4 \times V_{DRM}$
I_{GD}	Gate non-trigger current	10 mA	$V_D = 0.4 \times V_{DRM}$
V_{FGM}	Peak forward gate voltage	12 V	
I_{FGM}	Peak forward gate current	10 A	
V_{RGM}	Peak reverse gate voltage	10 V	
P_G	Gate power loss	3 W	

Thermal

T_{jmax}	Max. operating junction temperature range	125 °C	
T_{stg}	Storage temperature range	-40...140 °C	
R_{thJC}	Thermal resistance junction to case	20 K/kW	Anode side cooled
		20 K/kW	Cathode side cooled
		10 K/kW	Double side cooled
R_{thCH}	Thermal resistance case to heat sink	4 K/kW	Single side cooled
		2 K/kW	Double side cooled

Analytical function for transient thermal impedance:

$$Z_{thJC}(t) = \sum_{i=1}^n R_i(1 - e^{-t/\tau_i})$$

i	1	2	3	4
$R_i(K/kW)$	6.52	1.55	1.67	0.49
$\tau_i(s)$	0.4562	0.0792	0.0088	0.0037

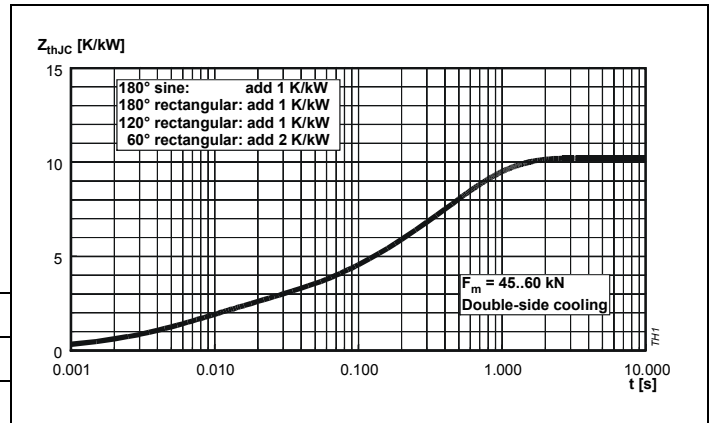

Fig. 1 Transient thermal impedance junction to case.

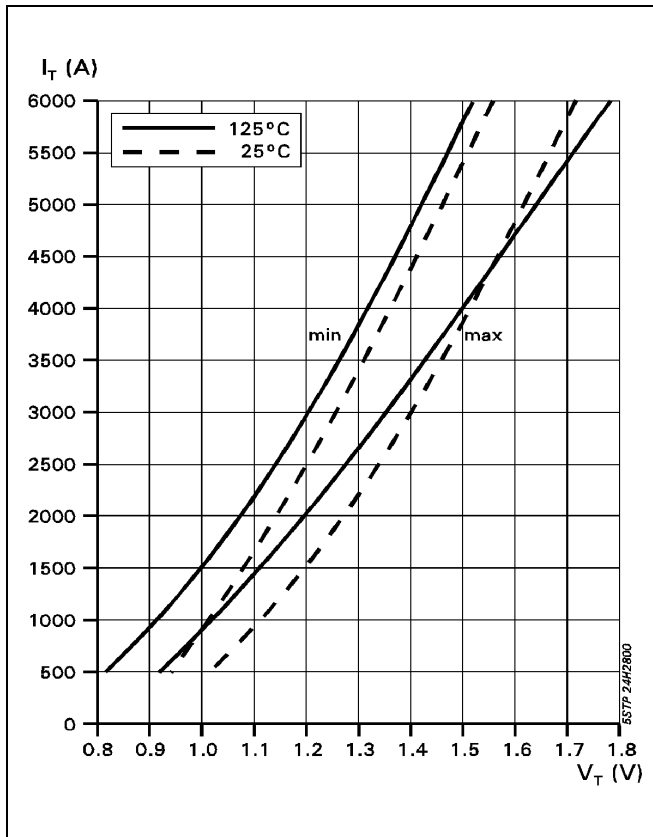

Fig. 2 On-state characteristics.

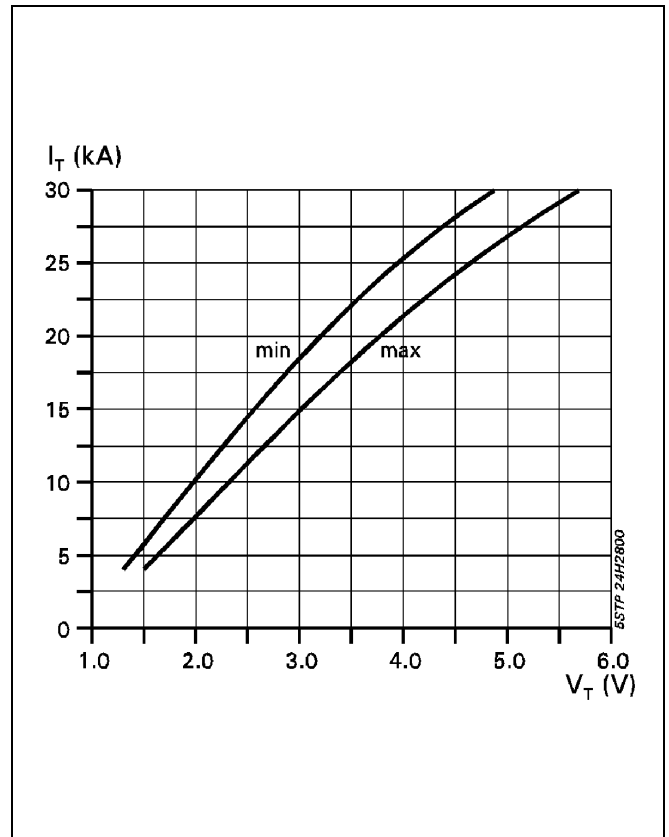

Fig. 3 On-state characteristics. $T_j=125^\circ\text{C}$, 10ms half sine

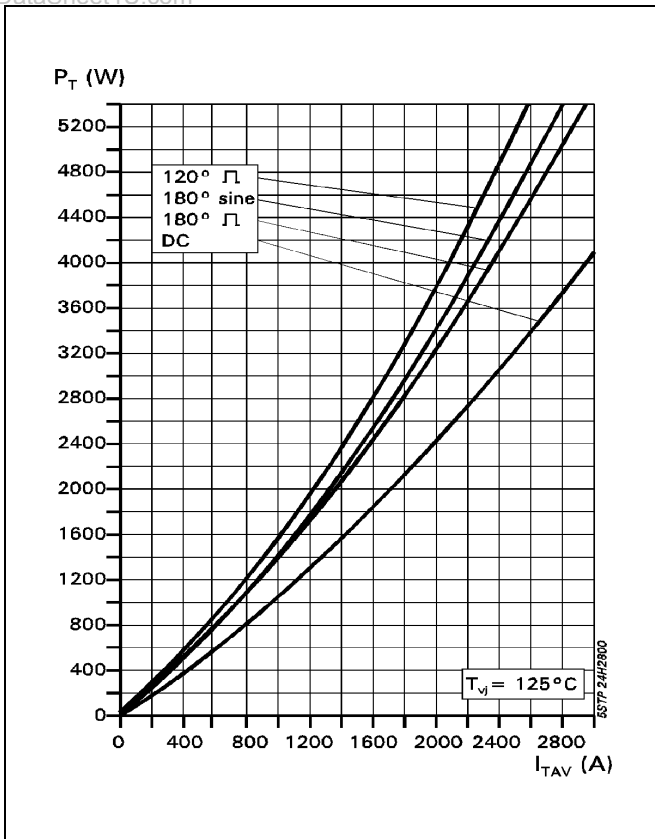

Fig. 4 On-state power dissipation vs. mean on-state current. Turn - on losses excluded.

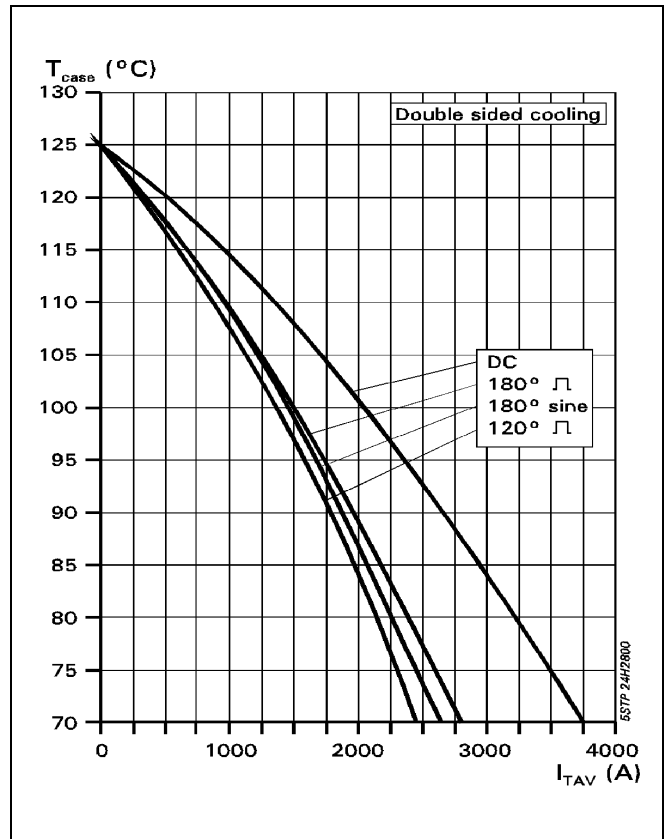

Fig. 5 Max. permissible case temperature vs. mean on-state current.

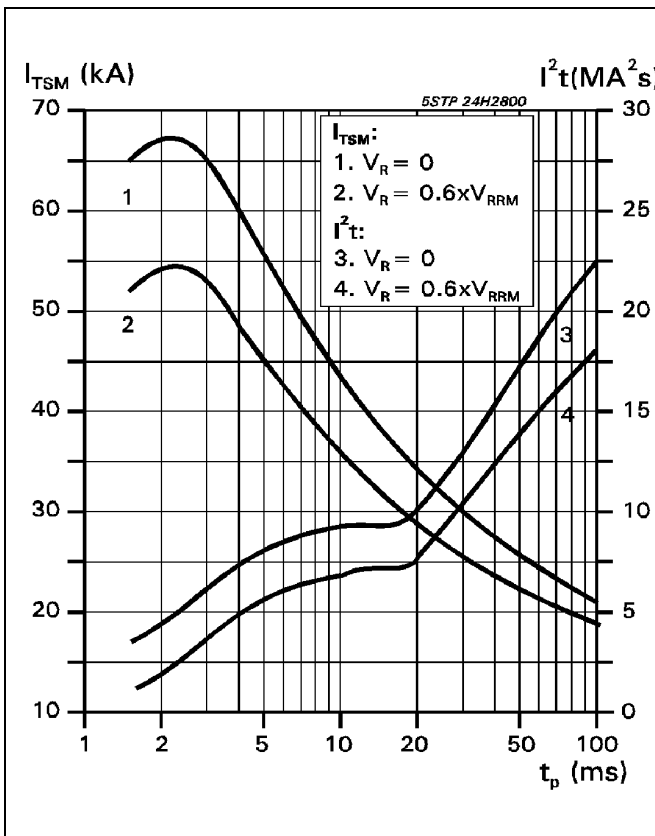

Fig. 6 Surge on-state current vs. pulse length. Half-sine wave.

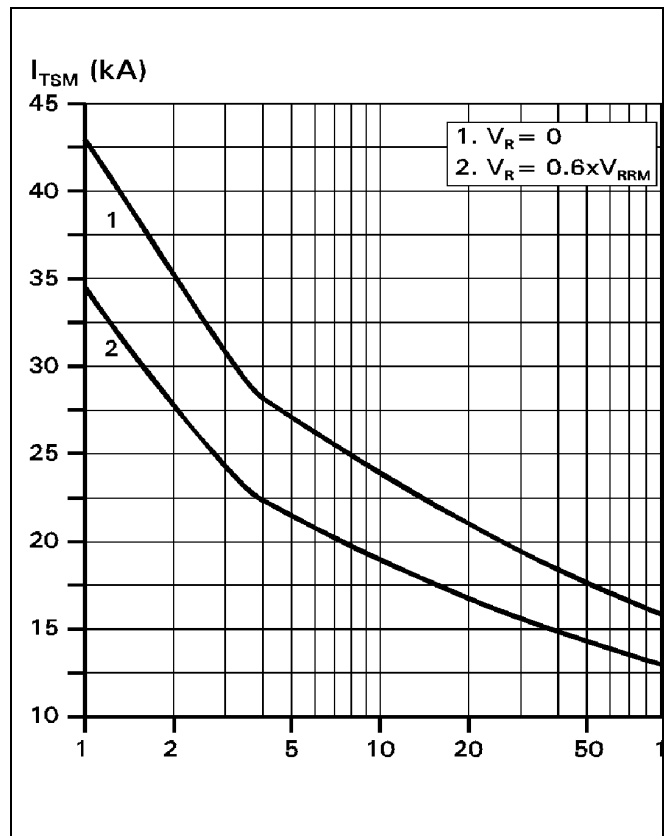

Fig. 7 Surge on-state current vs. number of pulses. Half-sine wave, 10 ms, 50Hz.

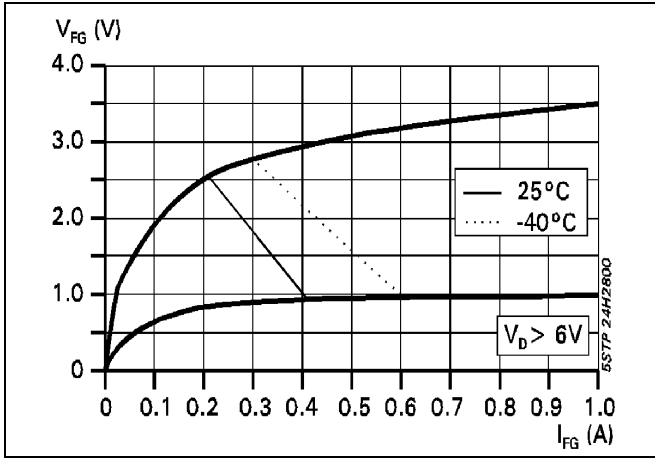

Fig. 8 Gate trigger characteristics.

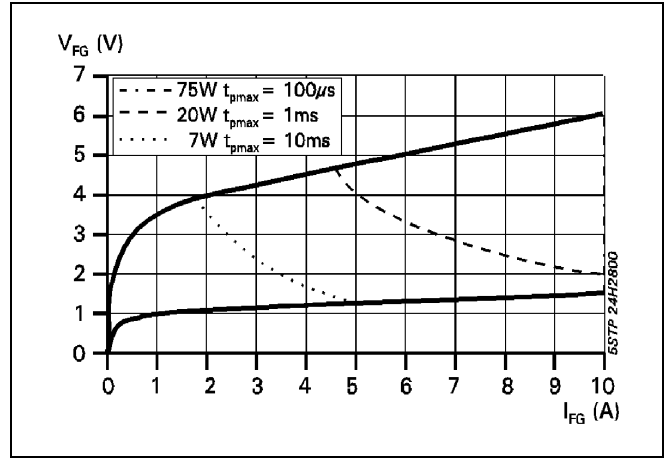

Fig. 9 Max. peak gate power loss.

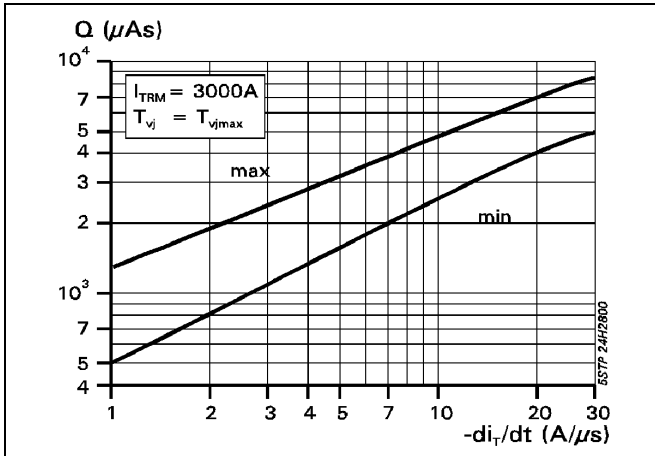

Fig. 10 Recovery charge vs. decay rate of on-state current.

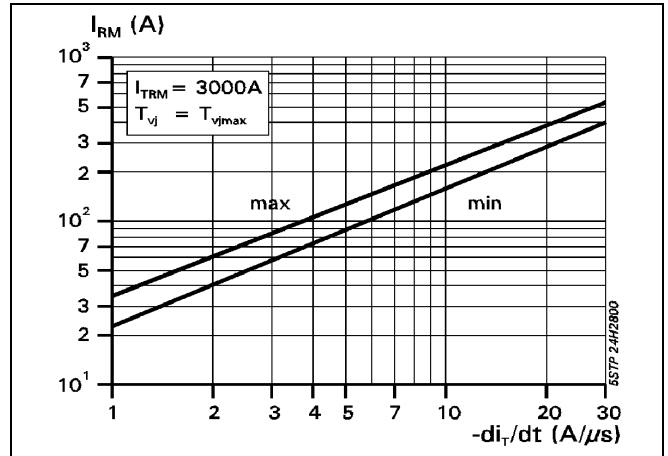

Fig. 11 Peak reverse recovery current vs. decay rate of on-state current.

ABB Semiconductors AG reserves the right to change specifications without notice.



ABB Semiconductors AG
 Fabrikstrasse 3
 CH-5600 Lenzburg, Switzerland

Telephone +41 (0)62 888 6419
 Fax +41 (0)62 888 6306
 Email abbsem@ch.abb.com
 Internet www.abbsem.com

Doc. No. 5SYA1047-02 Sep. 01