



60EPU02PbF
60APU02PbF

Ultrafast Soft Recovery Diode

Features

- Ultrafast Recovery
- 175°C Operating Junction Temperature
- Lead-Free ("PbF" suffix)

Benefits

- Reduced RFI and EMI
- Higher Frequency Operation
- Reduced Snubbing
- Reduced Parts Count

$t_{rr} = 35\text{ns}$
$I_{F(AV)} = 60\text{Amp}$
$V_R = 200\text{V}$

Description/ Applications



These diodes are optimized to reduce losses and EMI/ RFI in high frequency power conditioning systems. The softness of the recovery eliminates the need for a snubber in most applications. These devices are ideally suited for HF welding, power converters and other applications where switching losses are not significant portion of the total losses.

Absolute Maximum Ratings

Parameters	Max	Units
V_R Cathode to Anode Voltage	200	V
$I_{F(AV)}$ Continuous Forward Current, $T_C = 127^\circ\text{C}$	60	A
I_{FSM} Single Pulse Forward Current, $T_C = 25^\circ\text{C}$	800	
I_{FRM} ① Maximum Repetitive Forward Current	120	
T_J, T_{STG} Operating Junction and Storage Temperatures	- 55 to 175	$^\circ\text{C}$

① Square Wave, 20kHz

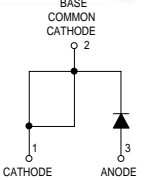
Case Styles

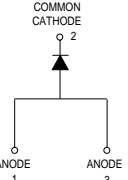
<p>60EPU02PbF</p>   <p>TO-247AC (Modified)</p>	<p>60APU02PbF</p>   <p>TO-247AC</p>
--	--

Electrical Characteristics @ T_J = 25°C (unless otherwise specified)

Parameters	Min	Typ	Max	Units	Test Conditions
V _{BR} , V _r Breakdown Voltage, Blocking Voltage	200	-	-	V	I _R = 100μA
V _F Forward Voltage	-	0.98	1.08	V	I _F = 60A
	-	0.81	0.88	V	I _F = 60A, T _J = 175°C
I _R Reverse Leakage Current	-	-	50	μA	V _R = V _R Rated
	-	-	2	mA	T _J = 150°C, V _R = V _R Rated
C _T Junction Capacitance	-	87	-	pF	V _R = 200V
L _S Series Inductance	-	8.0	-	nH	Measured lead to lead 5mm from package body

Dynamic Recovery Characteristics @ T_J = 25°C (unless otherwise specified)

Parameters	Min	Typ	Max	Units	Test Conditions
t _{rr} Reverse Recovery Time	-	-	35	ns	I _F = 1.0A, di _F /dt = 200A/μs, V _R = 30V
	-	28	-		T _J = 25°C
	-	50	-		T _J = 125°C
I _{RRM} Peak Recovery Current	-	4	-	A	T _J = 25°C
	-	8	-		T _J = 125°C
Q _{rr} Reverse Recovery Charge	-	59	-	nC	T _J = 25°C
	-	220	-		T _J = 125°C

I_F = 60A
V_R = 160V
di_F/dt = 200A/μs

Thermal - Mechanical Characteristics

Parameters	Min	Typ	Max	Units
R _{thJC} Thermal Resistance, Junction to Case			0.70	K/W
R _{thCS} ② Thermal Resistance, Case to Heatsink		0.2		
Wt Weight		5.5		g
		0.2		(oz)
T Mounting Torque			1.2	N*m
Marking Device	60EPU02, 60APU02			

② Mounting Surface, Flat, Smooth and Greased

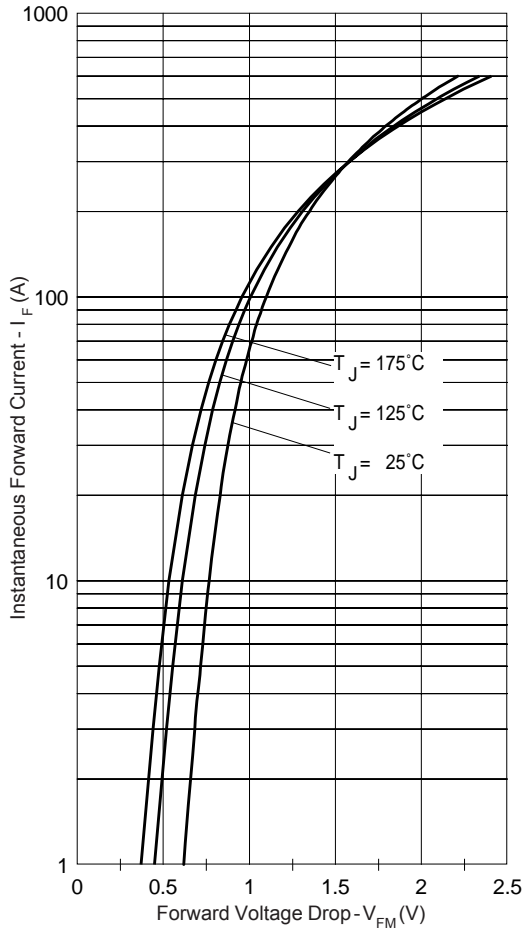

Fig. 1 - Typical Forward Voltage Drop Characteristics

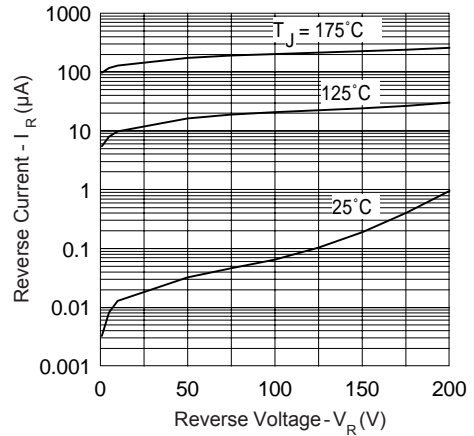

Fig. 2 - Typical Values Of Reverse Current Vs. Reverse Voltage

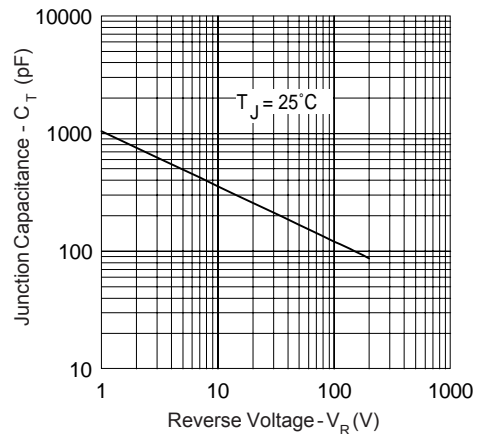

Fig. 3 - Typical Junction Capacitance Vs. Reverse Voltage

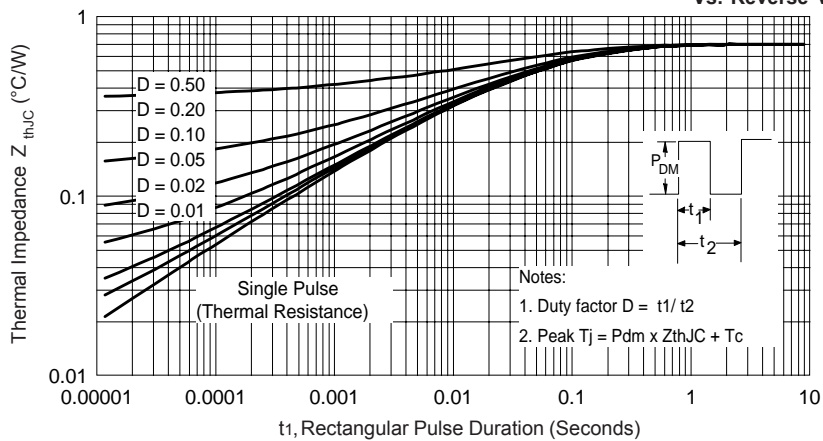

Fig. 4 - Max. Thermal Impedance Z_{thJC} Characteristics

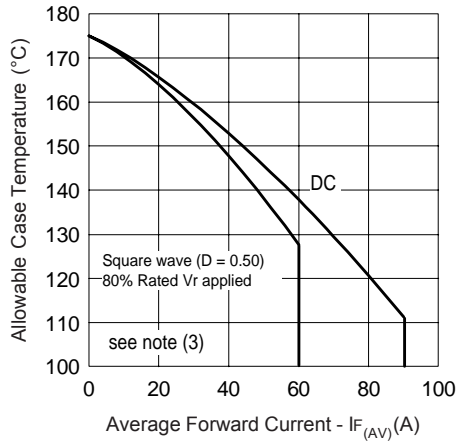

Fig. 5 - Max. Allowable Case Temperature Vs. Average Forward Current

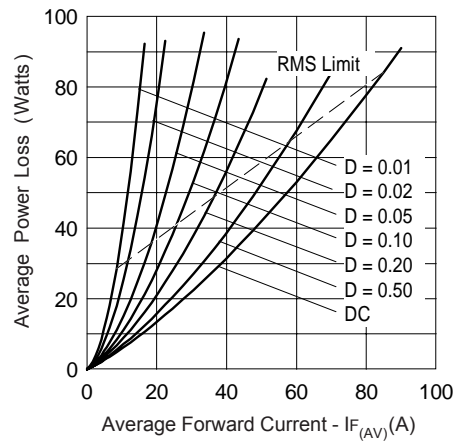

Fig. 6 - Forward Power Loss Characteristics

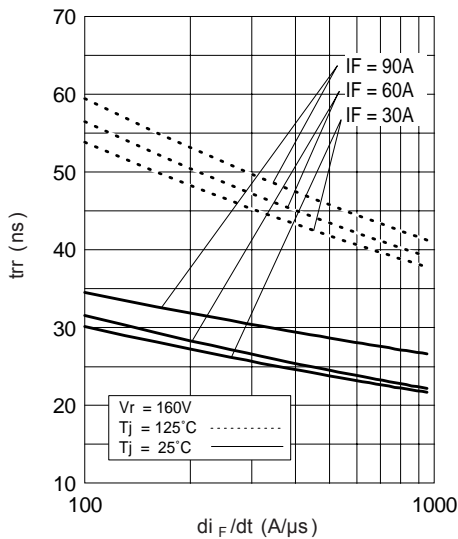

Fig. 7 - Typical Reverse Recovery time vs. di_F/dt

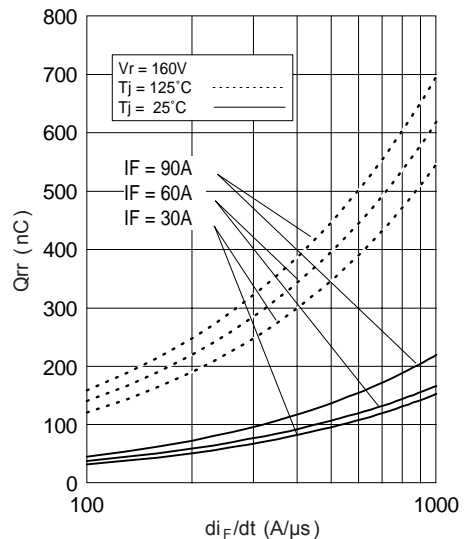

Fig. 8 - Typical Stored Charge vs. di_F/dt

(3) Formula used: $T_C = T_J - (Pd + Pd_{REV}) \times R_{thJC}$;

Pd = Forward Power Loss = $I_{F(AV)} \times V_{FM} @ (I_{F(AV)} / D)$ (see Fig. 6);

Pd_{REV} = Inverse Power Loss = $V_{R1} \times I_R (1 - D)$; $I_R @ V_{R1} = 80\%$ rated V_R

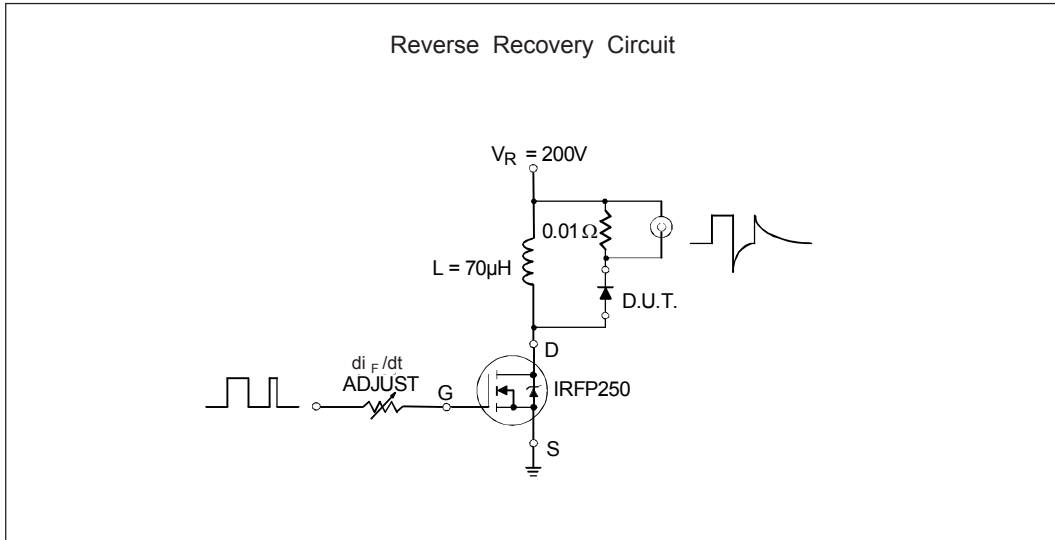

Fig. 9- Reverse Recovery Parameter Test Circuit

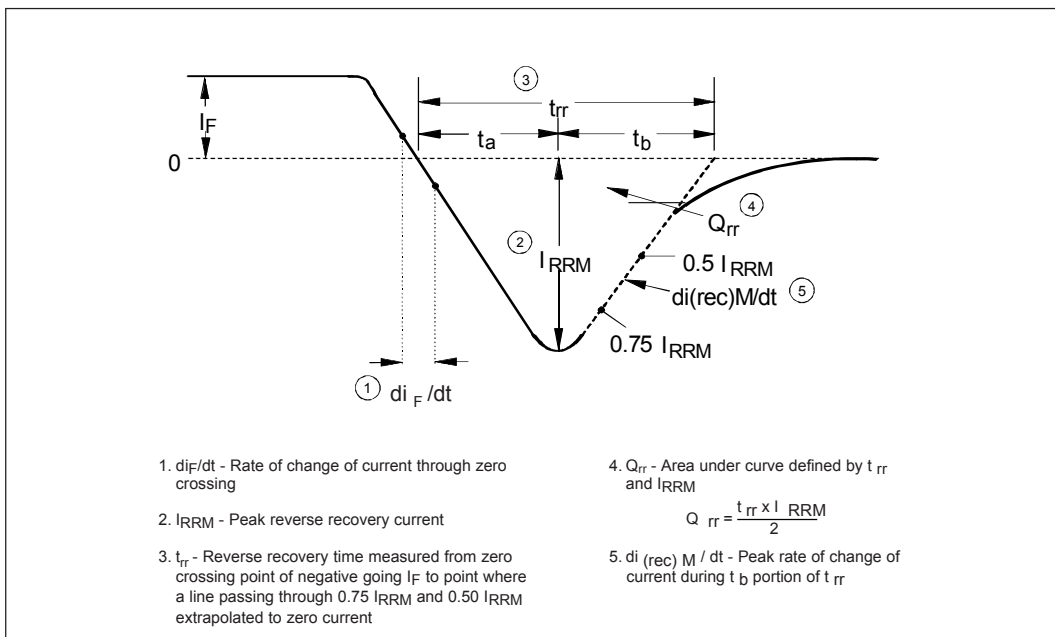
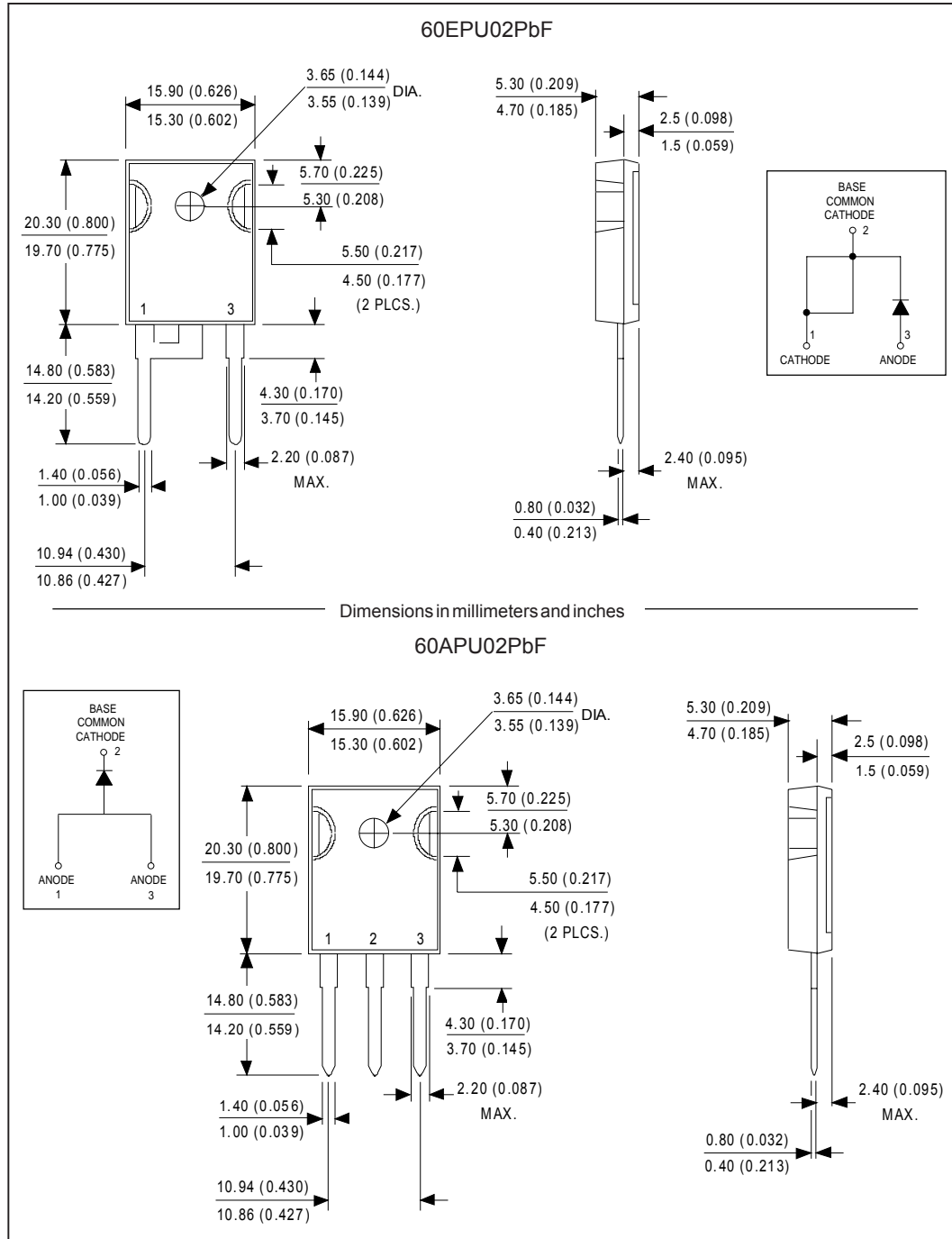

Fig. 10 - Reverse Recovery Waveform and Definitions

Outline Table



Marking Information

EXAMPLE: THIS IS A 60EPU02
 WITH ASSEMBLY
 LOT CODE 5657
 ASSEMBLED ON WW 35, 2000
 IN ASSEMBLY LINE "H"

PART NUMBER
 60EPU02
 DATE CODE
 P = LEAD-FREE
 YEAR 0 = 2000
 WEEK 35
 LINE H

EXAMPLE: THIS IS A 60APU02
 WITH ASSEMBLY
 LOT CODE 5657
 ASSEMBLED ON WW 35, 2000
 IN ASSEMBLY LINE "H"

PART NUMBER
 60APU02
 DATE CODE
 P = LEAD-FREE
 YEAR 0 = 2000
 WEEK 35
 LINE H

Ordering Information Table

Device Code					
60	E	P	U	02	PbF
①	②	③	④	⑤	⑥
1	- Current Rating (60 = 60A)				
2	- Circuit Configuration: E = Single Diode A = Single Diode, 3 pins				
3	- Package: P = TO-247AC (Modified)				
4	- Type of Silicon: U = UltraFast Recovery				
5	- Voltage Rating (02 = 200V)				
6	- • none = Standard Production • PbF = Lead-Free				

60EPU02PbF, 60APU02PbF

Bulletin PD-21079 08/05

International
IR Rectifier

Data and specifications subject to change without notice.
This product has been designed and qualified for Industrial Level and Lead-Free.
Qualification Standards can be found on IR's Web site.

International
IR Rectifier

IR WORLD HEADQUARTERS: 233 Kansas St., El Segundo, California 90245, USA Tel: (310) 252-7105
TAC Fax: (310) 252-7309
Visit us at www.irf.com for sales contact information. 08/05