

Fast Soft Recovery Rectifier Diode, 60 A

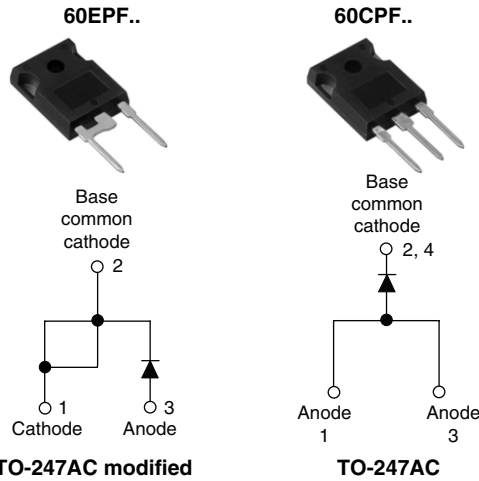

FEATURES/DESCRIPTION

The 60EPF.. and 60CPF.. fast soft recovery rectifier series has been optimized for combined short reverse recovery time and low forward voltage drop.

The glass passivation ensures stable reliable operation in the most severe temperature and power cycling conditions.

This product series has been designed and qualified for industrial level.

APPLICATIONS

- Output rectification and freewheeling in inverters, choppers and converters
- Input rectifications where severe restrictions on conducted EMI should be met

PRODUCT SUMMARY	
V_F at 30 A	< 1.2 V
t_{rr}	95 ns
V_{RRM}	1000 V/1200 V

MAJOR RATINGS AND CHARACTERISTICS			
SYMBOL	CHARACTERISTICS	VALUES	UNITS
V_{RRM}		1000/1200	V
$I_{F(AV)}$	Sinusoidal waveform	60	A
I_{FSM}		700	
t_{rr}	1 A, - 100 A/ μ s	95	ns
V_F	30 A, $T_J = 25^\circ\text{C}$	1.2	V
T_J	Range	- 40 to 150	$^\circ\text{C}$

VOLTAGE RATINGS			
PART NUMBER	V_{RRM} , MAXIMUM PEAK REVERSE VOLTAGE V	V_{RSM} , MAXIMUM NON-REPETITIVE PEAK REVERSE VOLTAGE V	I_{RRM} AT 150 $^\circ\text{C}$ mA
60EPF10, 60CPF10	1000	1100	8
60EPF12, 60CPF12	1200	1300	

ABSOLUTE MAXIMUM RATINGS				
PARAMETER	SYMBOL	TEST CONDITIONS	VALUES	UNITS
Maximum average forward current	$I_{F(AV)}$	$T_C = 103^\circ\text{C}$, 180 $^\circ$ conduction half sine wave	60	A
Maximum peak one cycle non-repetitive surge current	I_{FSM}	10 ms sine pulse, rated V_{RRM} applied	700	
		10 ms sine pulse, no voltage reapplied	830	
Maximum I^2t for fusing	I^2t	10 ms sine pulse, rated V_{RRM} applied	2450	A^2s
		10 ms sine pulse, no voltage reapplied	3460	
Maximum $I^2\sqrt{t}$ for fusing	$I^2\sqrt{t}$	$t = 0.1$ ms to 10 ms, no voltage reapplied	34 600	$\text{A}^2\sqrt{\text{s}}$

60EPF.., 60CPF.. Soft Recovery Series



Vishay High Power Products

Fast Soft Recovery
Rectifier Diode, 60 A

ELECTRICAL SPECIFICATIONS					
PARAMETER	SYMBOL	TEST CONDITIONS		VALUES	UNITS
Maximum forward voltage drop	V_{FM}	60 A, $T_J = 25\text{ }^\circ\text{C}$		1.4	V
Forward slope resistance	r_t	$T_J = 125\text{ }^\circ\text{C}$		4.6	$\text{m}\Omega$
Threshold voltage	$V_{F(TO)}$			0.9	V
Maximum reverse leakage current	I_{RM}	$T_J = 25\text{ }^\circ\text{C}$	$V_R = \text{Rated } V_{RRM}$	0.1	mA
		$T_J = 150\text{ }^\circ\text{C}$		8	

RECOVERY CHARACTERISTICS					
PARAMETER	SYMBOL	TEST CONDITIONS	VALUES	UNITS	
Reverse recovery time	t_{rr}	I_F at 60 Apk 25 A/ μs $25\text{ }^\circ\text{C}$	480	ns	
Reverse recovery current	I_{rr}		8	A	
Reverse recovery charge	Q_{rr}		2.7	μC	
Snap factor	S		0.6		

THERMAL - MECHANICAL SPECIFICATIONS				
PARAMETER	SYMBOL	TEST CONDITIONS	VALUES	UNITS
Maximum junction and storage temperature range	T_J, T_{Stg}		- 40 to 150	$^\circ\text{C}$
Maximum thermal resistance, junction to case	R_{thJC}	DC operation	0.4	$^\circ\text{C/W}$
Maximum thermal resistance, junction to ambient	R_{thJA}		40	
Typical thermal resistance, case to heatsink	R_{thCS}	Mounting surface, smooth and greased	0.2	
Approximate weight			6	g
			0.21	oz.
Mounting torque	minimum		6 (5)	kgf · cm (lbf · in)
	maximum		12 (10)	
Marking device		Case style TO-247AC modified (JEDEC)	60EPF10	
			60EPF12	
		Case style TO-247AC	60CPF10	
			60CPF12	



60EPF., 60CPF.. Soft Recovery Series

Fast Soft Recovery
Rectifier Diode, 60 A

Vishay High Power Products

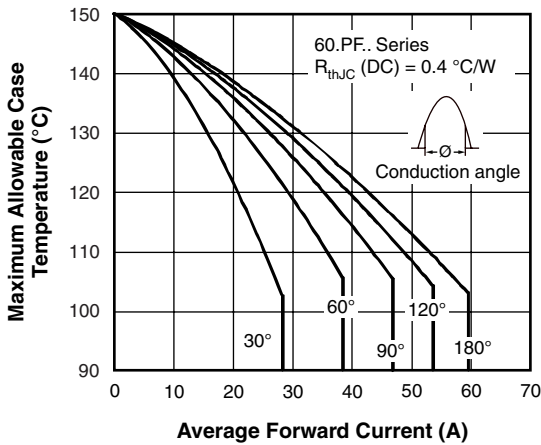

Fig. 1 - Current Rating Characteristics

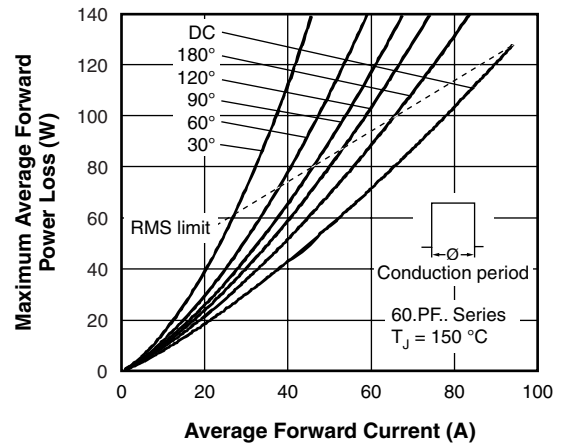

Fig. 4 - Forward Power Loss Characteristics

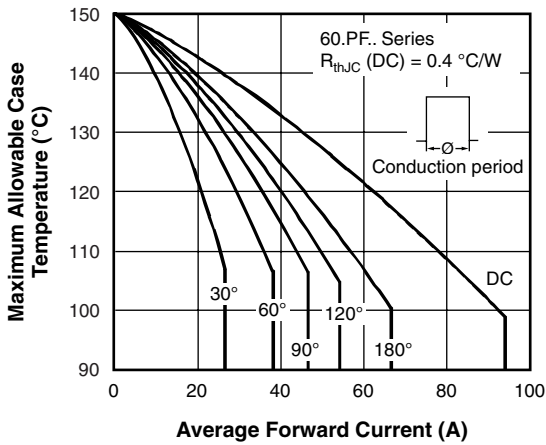

Fig. 2 - Current Rating Characteristics

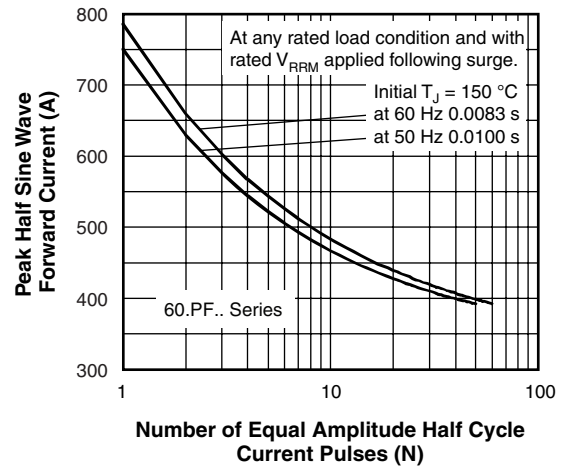

Fig. 5 - Maximum Non-Repetitive Surge Current

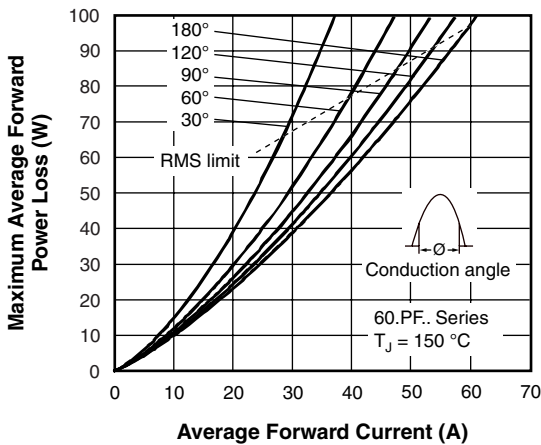

Fig. 3 - Forward Power Loss Characteristics

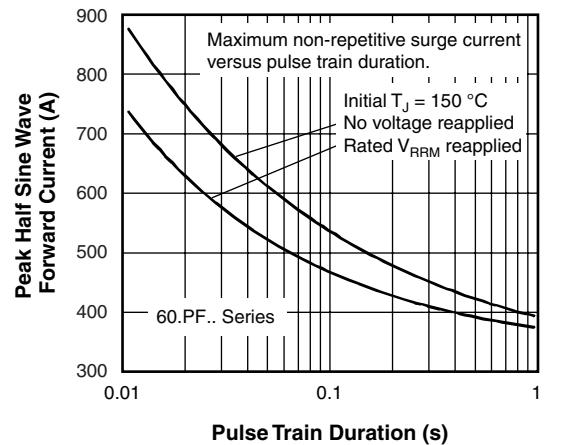

Fig. 6 - Maximum Non-Repetitive Surge Current

60EPF., 60CPF.. Soft Recovery Series



Vishay High Power Products

Fast Soft Recovery Rectifier Diode, 60 A

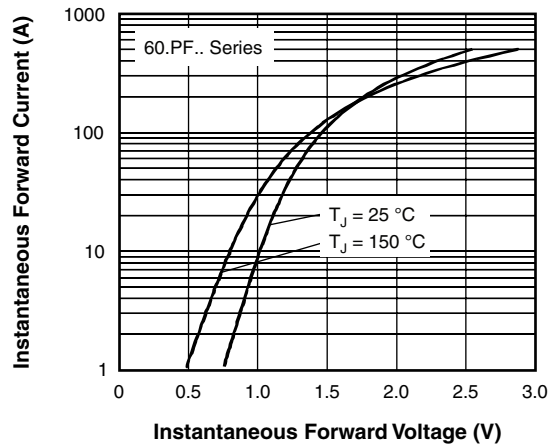

Fig. 7 - Forward Voltage Drop Characteristics

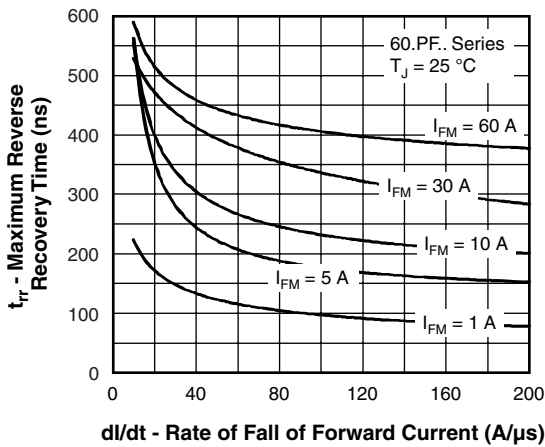

Fig. 8 - Recovery Time Characteristics, $T_J = 25\text{ }^\circ\text{C}$

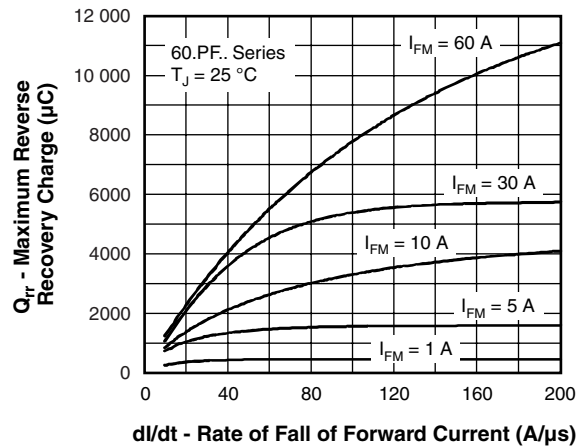

Fig. 10 - Recovery Charge Characteristics, $T_J = 25\text{ }^\circ\text{C}$

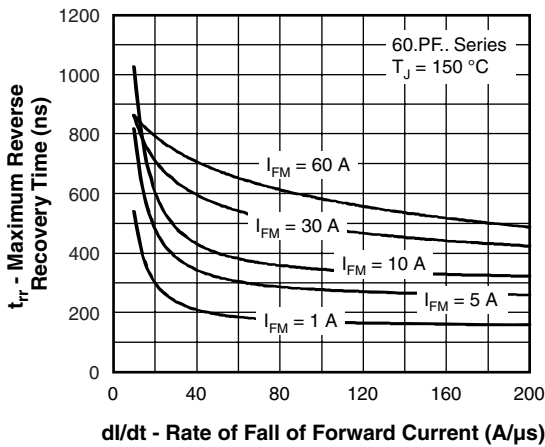

Fig. 9 - Recovery Time Characteristics, $T_J = 150\text{ }^\circ\text{C}$

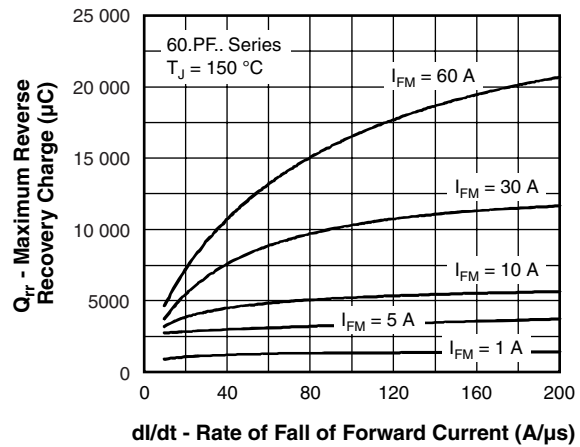

Fig. 11 - Recovery Charge Characteristics, $T_J = 150\text{ }^\circ\text{C}$



60EPF., 60CPF.. Soft Recovery Series

Fast Soft Recovery
Rectifier Diode, 60 A

Vishay High Power Products

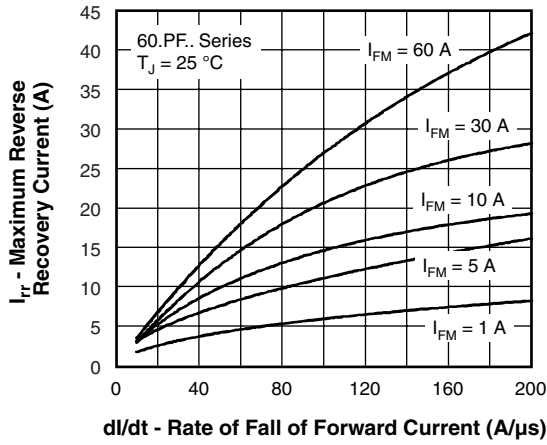

Fig. 12 - Recovery Current Characteristics, $T_J = 25\text{ }^\circ\text{C}$

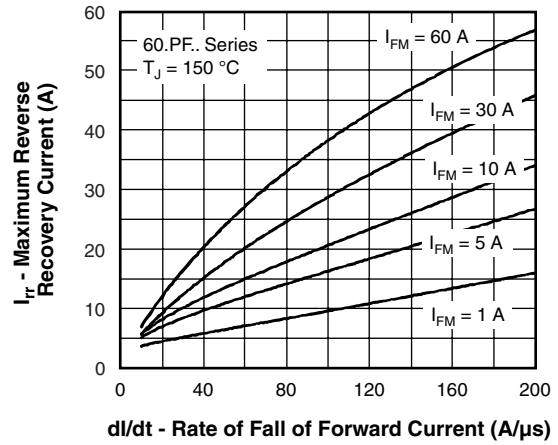

Fig. 13 - Recovery Current Characteristics, $T_J = 150\text{ }^\circ\text{C}$

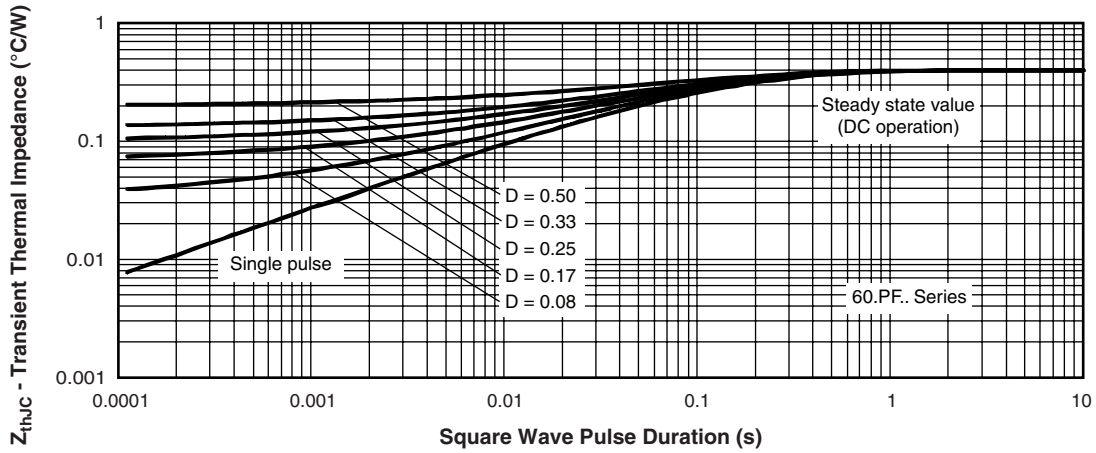

Fig. 14 - Thermal Impedance Z_{thJC} Characteristics

60EPF.., 60CPF.. Soft Recovery Series



Vishay High Power Products

Fast Soft Recovery
Rectifier Diode, 60 A

ORDERING INFORMATION TABLE

Device code	60	E	P	F	12	-
	①	②	③	④	⑤	⑥
	1	-	Current rating (60 = 60 A)			
	2	-	Circuit configuration:			
			E = Single diode			
			C = Single diode, 3 pins			
	3	-	Package:			
			P = TO-247AC modified			
	4	-	Type of silicon:			
			F = Fast recovery			
	5	-	Voltage code x 100 = V_{RRM}			
						10 = 1000 V 12 = 1200 V
	6	-	• None = Standard production			
			• PbF = Lead (Pb)-free			

LINKS TO RELATED DOCUMENTS		
Dimensions	TO-247AC modified	www.vishay.com/doc?95253
	TO-247AC	www.vishay.com/doc?95223
Part marking information	TO-247AC modified	www.vishay.com/doc?95255
	TO-247AC	www.vishay.com/doc?95226



Disclaimer

All product specifications and data are subject to change without notice.

Vishay Intertechnology, Inc., its affiliates, agents, and employees, and all persons acting on its or their behalf (collectively, "Vishay"), disclaim any and all liability for any errors, inaccuracies or incompleteness contained herein or in any other disclosure relating to any product.

Vishay disclaims any and all liability arising out of the use or application of any product described herein or of any information provided herein to the maximum extent permitted by law. The product specifications do not expand or otherwise modify Vishay's terms and conditions of purchase, including but not limited to the warranty expressed therein, which apply to these products.

No license, express or implied, by estoppel or otherwise, to any intellectual property rights is granted by this document or by any conduct of Vishay.

The products shown herein are not designed for use in medical, life-saving, or life-sustaining applications unless otherwise expressly indicated. Customers using or selling Vishay products not expressly indicated for use in such applications do so entirely at their own risk and agree to fully indemnify Vishay for any damages arising or resulting from such use or sale. Please contact authorized Vishay personnel to obtain written terms and conditions regarding products designed for such applications.

Product names and markings noted herein may be trademarks of their respective owners.