

Power MOSFET

60 Amps,30Volts N-Channel DPAK

Designed for low voltage, high speed switching applications in power supplies, converters and power motor controls and bridge circuits.

Typical Applications

- Power Supplies
- Converters
- Power Motor Controls
- Bridge Circuits

MAXIMUM RATINGS (T_J = 25°C unless otherwise noted)

Rating	Symbol	Value	Unit
Drain-to-Source Voltage	V _{DSS}	30	Vdc
Gate-to-Source Voltage - Continuous	V _{GS}	±20	Vdc
Drain Current - Continuous @ T _A = 25°C - Single Pulse (t _p = 10 μs)	I _D I _{DM}	60* 120	Adc
Total Power Dissipation @ T _A = 25°C	P _D	75	Watts
Operating and Storage Temperature Range	T _J , T _{stg}	- 55 to 150	°C
Single Pulse Drain-to-Source Avalanche Energy - Starting T _J = 25°C (V _{DD} = 28 Vdc, V _{GS} = 10 Vdc, I _L = 17 Apk, L = 5.0 mH, R _G = 25 Ω)	E _{AS}	733	mJ
Thermal Resistance - Junction-to-Case - Junction-to-Ambient (Note 1) - Junction-to-Ambient (Note 2)	R _{θJC} R _{θJA} R _{θJA}	1.65 67 120	°C/W
Maximum Lead Temperature for Soldering Purposes, 1/8" from case for 10 seconds	T _L	260	°C

1. When surface mounted to an FR4 board using 1" pad size, (Cu Area 1.127 in²).
2. When surface mounted to an FR4 board using the minimum recommended pad size, (Cu Area 0.412 in²).

*Chip current capability limited by package.

60 AMPERES

30 VOLTS

R_{DS(on)} = 9.0 mΩ (Typ.)

N-Channel

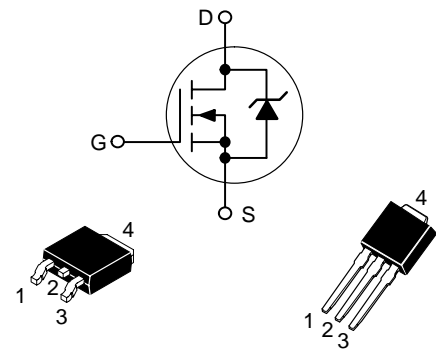

60N03

ELECTRICAL CHARACTERISTICS (T_J = 25°C unless otherwise noted)

Characteristic	Symbol	Min	Typ	Max	Unit
----------------	--------	-----	-----	-----	------

OFF CHARACTERISTICS

Drain-to-Source Breakdown Voltage (Note 3) (V _{GS} = 0 Vdc, I _D = 250 μAdc) Temperature Coefficient (Positive)	V _{(BR)DSS}	30		-	Vdc
Zero Gate Voltage Drain Current (V _{GS} = 0 Vdc, V _{DS} = 24 Vdc)	I _{DSS}	-	-	50	nAdc
Gate-Body Leakage Current (V _{GS} = ±20 Vdc, V _{DS} = 0 Vdc)	I _{GSS}	-	-	±100	nAdc

ON CHARACTERISTICS (Note 3)

Gate Threshold Voltage (Note 3) (V _{DS} = V _{GS} , I _D = 250 μAdc) Threshold Temperature Coefficient (Negative)	V _{GS(th)}	1.0 -	1.9 -3.8	2.0 -	Vdc mV/°C
Static Drain-to-Source On-Resistance (Note 3) (V _{GS} = 10 Vdc, I _D = 35 Adc) (V _{GS} = 4.5 Vdc, I _D = 20 Adc)	R _{DS(on)}			9.0 15.0	mΩ
Forward Transconductance (V _{DS} = 15 Vdc, I _D = 10 Adc) (Note 3)	g _{FS}	-	20	-	Mhos

DYNAMIC CHARACTERISTICS

Input Capacitance	(V _{DS} = 24 Vdc, V _{GS} = 0 Vdc, f = 1.0 MHz)	C _{iSS}	-	2150	-	pF
Output Capacitance		C _{oSS}	-	680	-	
Transfer Capacitance		C _{rSS}	-	260	-	

SWITCHING CHARACTERISTICS (Note 4)

Turn-On Delay Time	(V _{DD} = 15 Vdc, I _D = 15 Adc, V _{GS} = 10 Vdc, R _G = 3.3 Ω)	t _{d(on)}	-	10	-	ns
Rise Time		t _r	-	18	-	
Turn-Off Delay Time		t _{d(off)}	-	32	-	
Fall Time		t _f	-	15	-	
Gate Charge	(V _{DS} = 24 Vdc, I _D = 15 Adc, V _{GS} = 4.5 Vdc) (Note 3)	Q _T	-	30	-	nC
		Q ₁	-	6.5	-	
		Q ₂	-	18.4	-	

SOURCE-DRAIN DIODE CHARACTERISTICS

Forward On-Voltage (I _S = 2.3 Adc, V _{GS} = 0 Vdc) (Note 3) (I _S = 30 Adc, V _{GS} = 0 Vdc) (I _S = 2.3 Adc, V _{GS} = 0 Vdc, T _J = 150°C)	V _{SD}	- - -	0.75 1.2 0.65	1.0 - -	Vdc	
Reverse Recovery Time	(I _S = 2.3 Adc, V _{GS} = 0 Vdc, di _S /dt = 100 A/μs) (Note 3)	t _{rr}	-	39	-	ns
		t _a	-	21	-	
		t _b	-	18	-	
Reverse Recovery Stored Charge	Q _{rr}	-	0.043	-	μC	

- Pulse Test: Pulse Width ≤ 300 μs, Duty Cycle ≤ 2%.
- Switching characteristics are independent of operating junction temperatures.

60N03

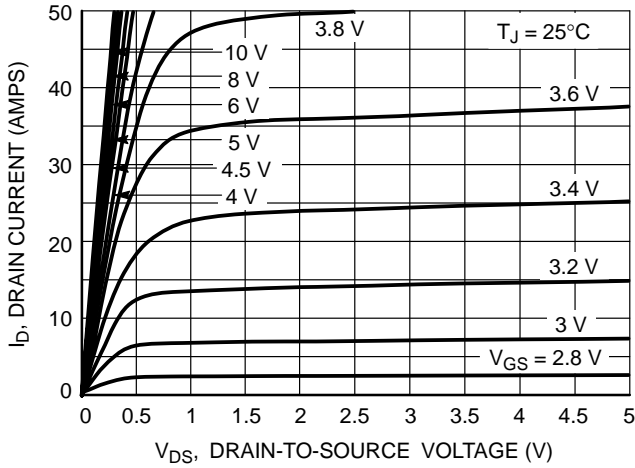

Figure 1. On-Region Characteristics

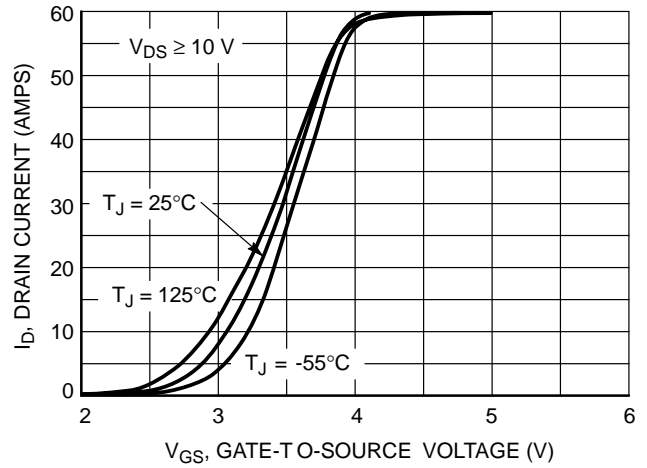

Figure 2. Transfer Characteristics

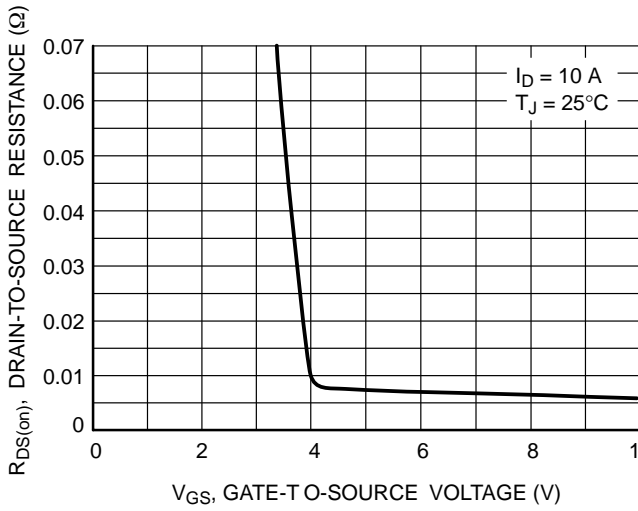

Figure 3. On-Resistance versus Gate-to-Source Voltage

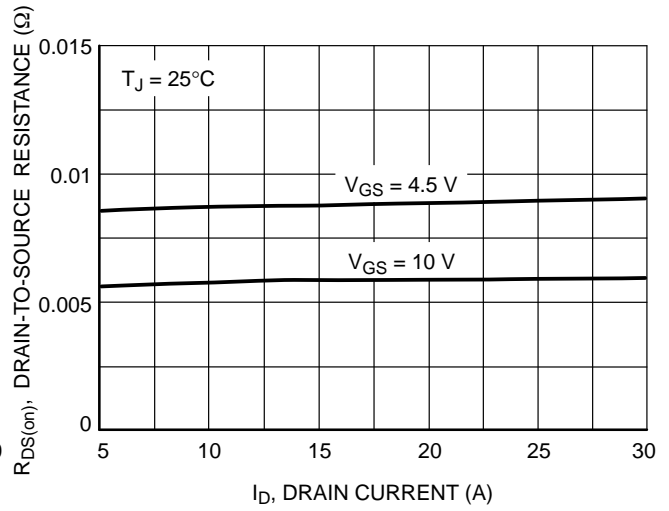

Figure 4. On-Resistance versus Drain Current and Gate Voltage

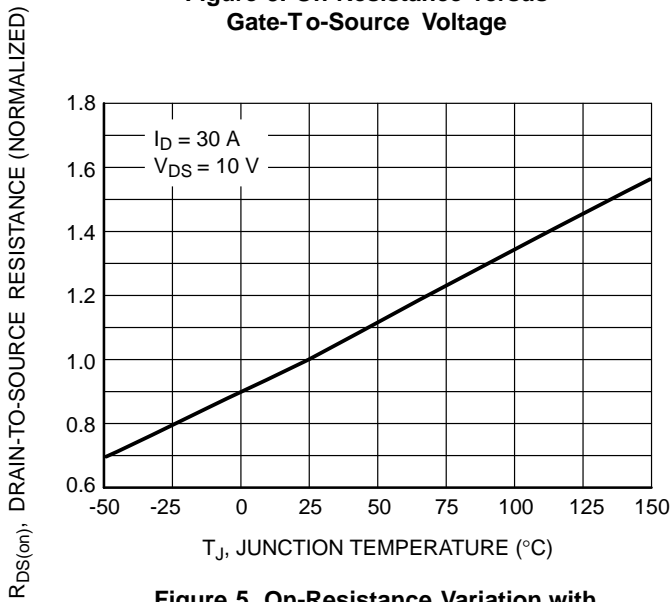

Figure 5. On-Resistance Variation with Temperature

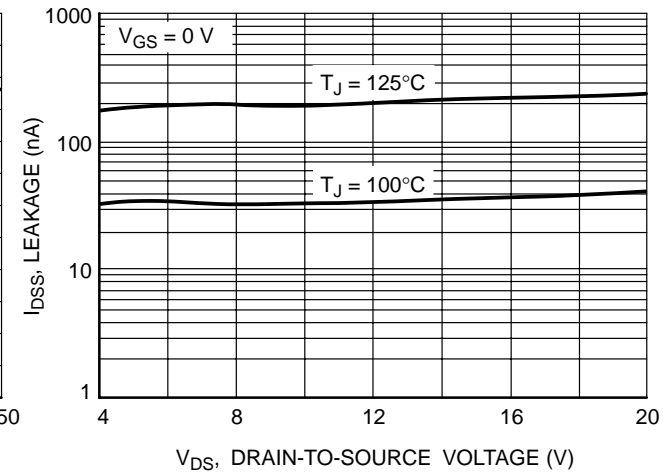

Figure 6. Drain-to-Source Leakage Current versus Voltage

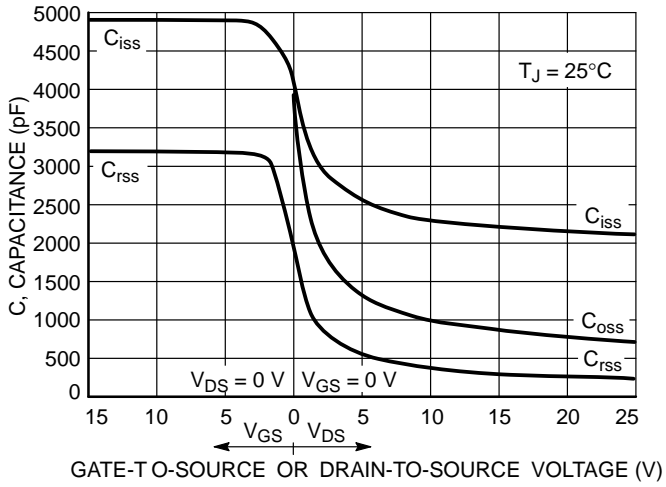

Figure 7. Capacitance Variation

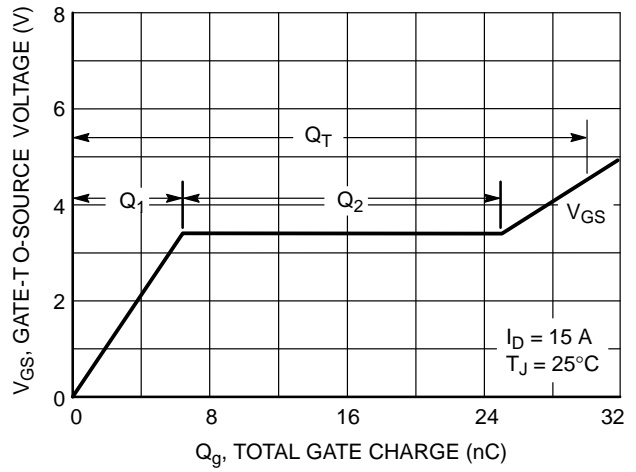

Figure 8. Gate-to-Source and Drain-to-Source Voltage versus Total Charge

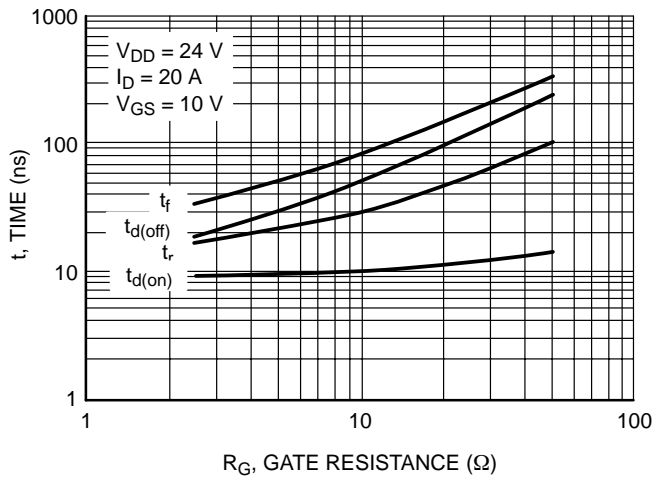

Figure 9. Resistive Switching Time Variation versus Gate Resistance

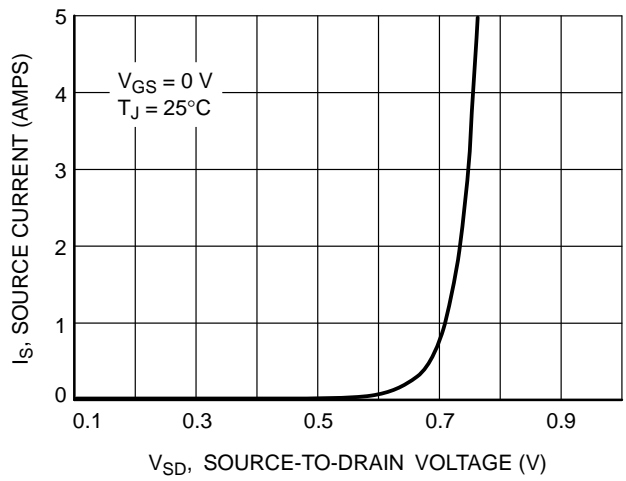

Figure 10. Diode Forward Voltage versus Current

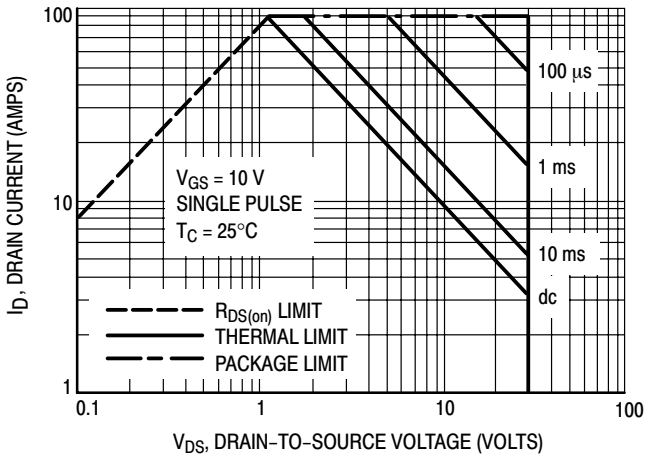

Figure 11. Maximum Rated Forward Biased Safe Operating Area

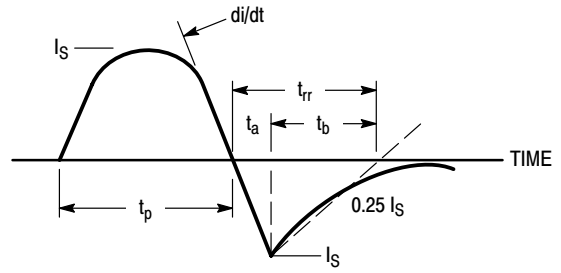

Figure 12. Diode Reverse Recovery Waveform

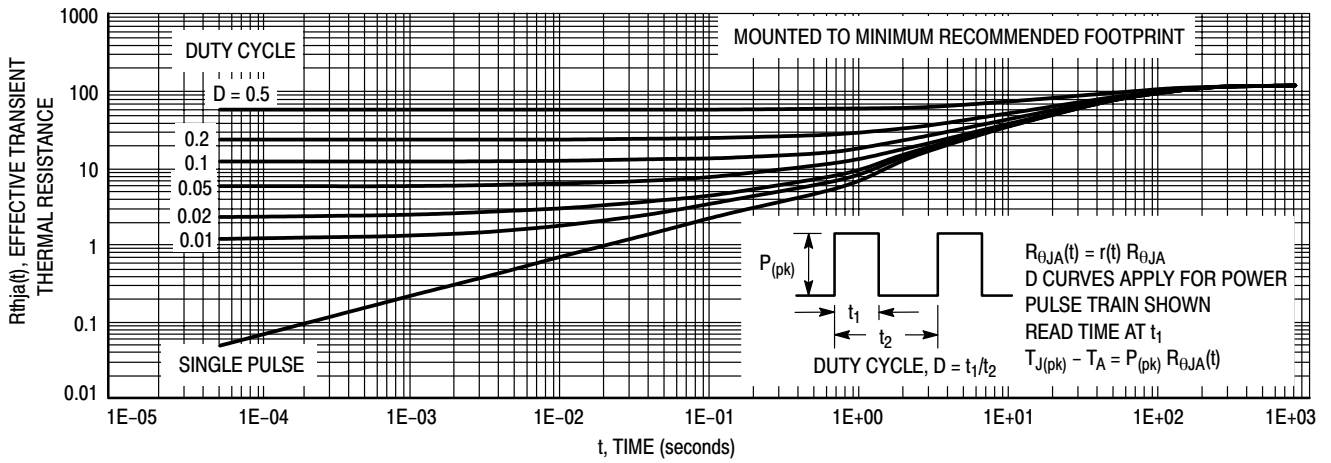
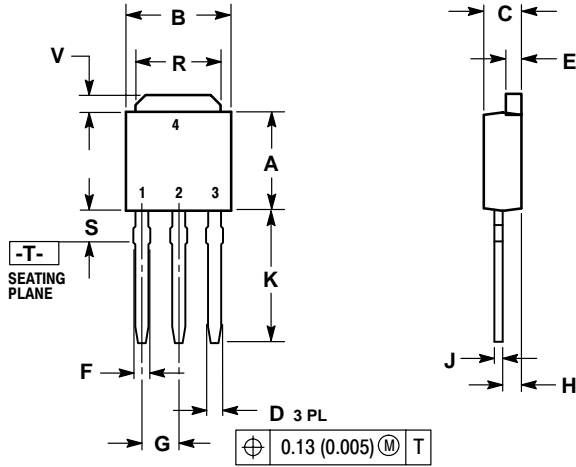

Figure 13. Thermal Response - Various Duty Cycles

60N03

PACKAGE DIMENSIONS

DPAK, STRAIGHT LEAD CASE 369-07 ISSUE M



- NOTES:
1. DIMENSIONING AND TOLERANCING PER ANSI Y14.5M, 1982.
 2. CONTROLLING DIMENSION: INCH.

DIM	INCHES		MILLIMETERS	
	MIN	MAX	MIN	MAX
A	0.235	0.250	5.97	6.35
B	0.250	0.265	6.35	6.73
C	0.086	0.094	2.19	2.38
D	0.027	0.035	0.69	0.88
E	0.033	0.040	0.84	1.01
F	0.037	0.047	0.94	1.19
G	0.090 BSC		2.29 BSC	
H	0.034	0.040	0.87	1.01
J	0.018	0.023	0.46	0.58
K	0.350	0.380	8.89	9.65
R	0.175	0.215	4.45	5.46
S	0.050	0.090	1.27	2.28
V	0.030	0.050	0.77	1.27

- STYLE 2:
- PIN 1. GATE
 2. DRAIN
 3. SOURCE
 4. DRAIN

60N03R

PACKAGE DIMENSIONS

DPAK
CASE 369A-13
ISSUE AB

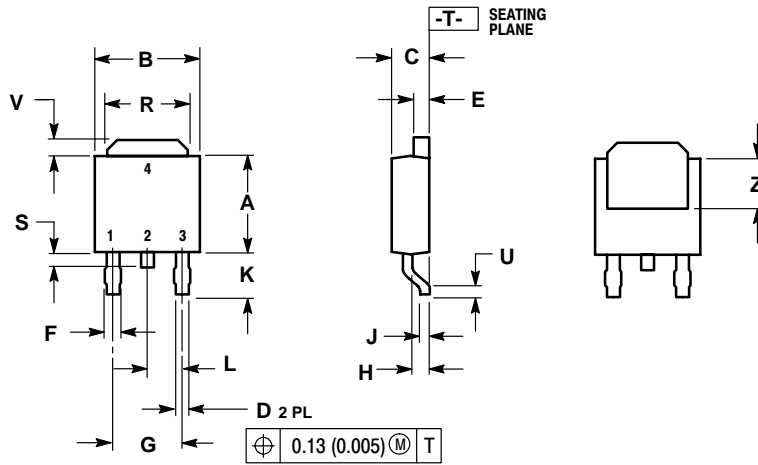

- NOTES:
1. DIMENSIONING AND TOLERANCING PER ANSI Y14.5M, 1982.
2. CONTROLLING DIMENSION: INCH.

DIM	INCHES		MILLIMETERS	
	MIN	MAX	MIN	MAX
A	0.235	0.250	5.97	6.35
B	0.250	0.265	6.35	6.73
C	0.086	0.094	2.19	2.38
D	0.027	0.035	0.69	0.88
E	0.033	0.040	0.84	1.01
F	0.037	0.047	0.94	1.19
G	0.180 BSC		4.58 BSC	
H	0.034	0.040	0.87	1.01
J	0.018	0.023	0.46	0.58
K	0.102	0.114	2.60	2.89
L	0.090 BSC		2.29 BSC	
R	0.175	0.215	4.45	5.46
S	0.020	0.050	0.51	1.27
U	0.020	---	0.51	---
V	0.030	0.050	0.77	1.27
Z	0.138	---	3.51	---

- STYLE 2:
PIN 1. GATE
2. DRAIN
3. SOURCE
4. DRAIN