



Microsemi Corp.
The diode experts

60S SERIES

SCOTTSDALE, AZ

For more information call:
(602) 941-6300

DESCRIPTION/FEATURES

- ECONOMICAL 6 AMP I_O MOLDED DEVICE OFFERS CAPABILITY OF STUD-MOUNTED RECTIFIERS
- 400 AMPS SURGE PROVIDES HIGH IN-RUSH CURRENT CAPABILITY
- WIDE VOLTAGE RANGE AVAILABLE: 50 TO 1000 VOLTS V_{RRM}

Major Ratings and Characteristics

60S		
$I_F(AV)$	6	A
@ Max. T_L	95	$^{\circ}C$
I_{FSM}	@ 50 Hz	382
	@ 60 Hz	400
i^2t	@ 50 Hz	712
	@ 60 Hz	650
T_J	-40 to 175	$^{\circ}C$
V_{RRM} Range	50-1000	V

VOLTAGE RATINGS

Part Number	Working V_{RRM} (V)	V_{SR} - Max. Direct Reverse Voltage (V)
	$T_J = -40^{\circ}C$ to $200^{\circ}C$	$T_J = -40^{\circ}C$ to $200^{\circ}C$
60S05	50	50
60S1	100	100
60S2	200	200
60S4	400	400
60S5	500	500
60S6	600	600
60S8	800	800
60S10	1000	1000

ELECTRICAL SPECIFICATIONS

		60S	Units	Conditions
$I_F(AV)$	Max. average forward current	6	A	1 phase operation, 180 $^{\circ}$ conduction, $T_L = 95^{\circ}C$, $l = 9.5$ mm (0.375 in.)
I_{FSM}	Max. peak one-cycle non-repetitive surge current	382	A	Half cycle 50 Hz sine wave or 6 ms rectangular pulse following any rated load condition and with rated V_{RRM} applied.
		400		Half cycle 60 Hz sine wave or 5 ms rectangular pulse
		454		Half cycle 50 Hz sine wave or 6 ms rectangular pulse following any rated load condition and with V_{RRM} applied following surge = 0.
		475		Half cycle 60 Hz sine wave or 5 ms rectangular pulse
i^2t	Max. i^2t for fusing	712	A^2s	$t = 10$ ms With rated V_{RRM} applied following surge, initial $T_J = 175^{\circ}C$
		650		$t = 8.3$ ms With $V_{RRM} = 0$ following surge, initial $T_J = 175^{\circ}C$
	1006	$t = 10$ ms		
	919	$t = 8.3$ ms		
$i^2\sqrt{t}$	Max. $i^2\sqrt{t}$ for individual device fusing (1)	10 330	$A^2\sqrt{s}$	$t = 0.1$ to 10 ms, $V_{RRM} = 0$ following surge.
V_{FM}	Max. peak forward voltage	1.00	V	$I_F(AV) = 6A$ (18.8A peak), $T_J = 25^{\circ}C$
$I_{R(AV)}$	Max. average reverse current	2.0	mA	Max. rated $I_F(AV)$ and V_{RRM} , $T_C = 95^{\circ}C$, length of leads to the temperature measurement points (heat sinks) = 9.5 mm (0.375 in.)
		1		
		0.8		
		0.5		

THERMAL-MECHANICAL SPECIFICATIONS

T_J	Max. operating junction temperature range	-40 to 175	$^{\circ}C$	
T_{stg}	Max. storage temperature range	-40 to 175	$^{\circ}C$	
R_{thJC}	Max. internal thermal resistance, junction-to-leads	-	deg C/W	DC operation, double side cooled, measured 9.5 mm (0.375 in.) from body.
		Length of leads (1) (1/8") 3.2 mm		
θ	Length of leads (1) (3/8") 9.5 mm	14.7	$\leq 10\%$	
		Length of leads (1) (3/4") 19 mm		
wt	Approximate weight	1.5 (0.053)	g (oz)	

Note (1): I^2t for time $t_x = I^2\sqrt{t} - \sqrt{t_x}$

6 AMP AXIAL-LEAD SILICON RECTIFIER DIODES

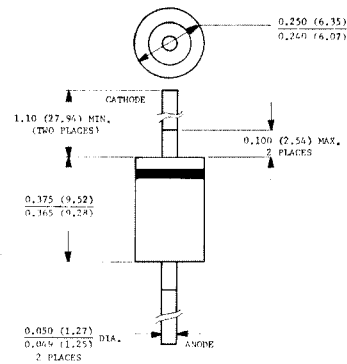

All Dimensions in Inches and (Millimeters)

MECHANICAL CHARACTERISTICS

CASE: Molded plastic use Flame Retardant Epoxy.

TERMINALS: Axial leads, solderable per MIL-STD-202, Method 208.

POLARITY: Color band denotes cathode.

MOUNTING POSITION: Any.

60S Series

RATING AND CHARACTERISTIC CURVES

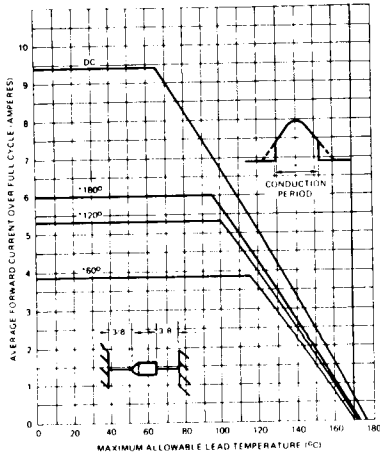

Fig. 1 - Average Forward Current Vs. Lead Temperature at Heat Sinks ($l = 3/8$ inch)

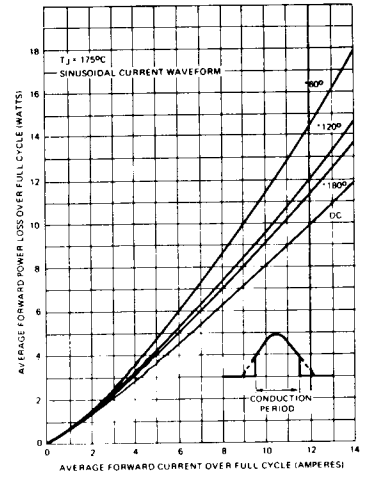

Fig. 2 - Maximum Average Forward Power Loss Vs. Low-Level Average Forward Current

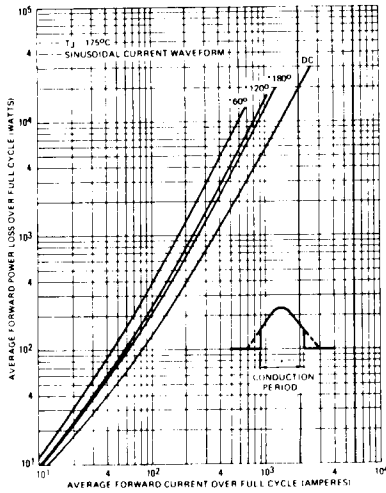

Fig. 3 - Maximum Average Forward Power Loss Vs. High-Level Forward Current

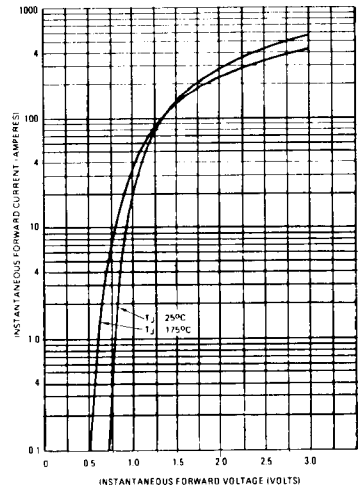

Fig. 4 - Maximum Instantaneous Forward Voltage Vs. Instantaneous Forward Current

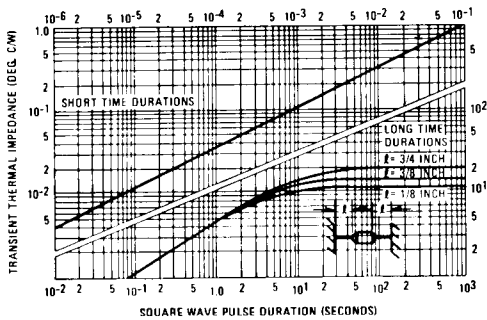

Fig. 5 - Maximum Transient Thermal Impedance, Vs. Square Wave Pulse Duration

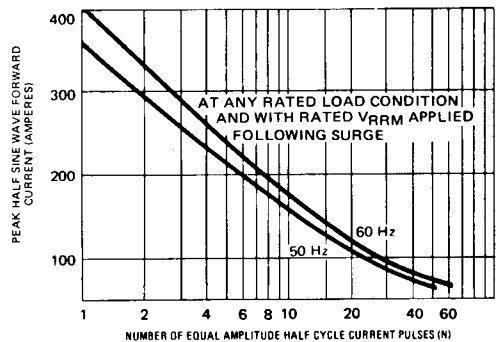

Fig. 6 - Maximum Non-Repetitive Surge Current Vs. Number of Current Pulses