

Technical Data Sheet

Top View LEDs

61-238/RSGCBKC-B02/ET

Features

- Super-luminosity chip LED.
- White SMT package.
- Built in Red, Green, and Blue chips.
- Lead frame package with individual 6 pins.
- Wide viewing angle.
- Soldering methods: IR reflow soldering.
- Pb-free.
- The product itself will remain within RoHS compliant version.



Descriptions

- Due to the package design, 61-238 has wide viewing angle, and low power consumption. The white LED which was fabricated using blue LEDs and a phosphor, and the phosphor is excited by blue light and emits yellow fluorescence. The mixture of blue light and yellow light results in a white emission. And makes it ideal for light pipe application.

Applications

- Amusement equipment.
- Information boards.
- Flashlight for digital camera of cellular phone.

Device Selection Guide

Chip		Emitted Color	Resin Color
Type	Material		
RS	AlGaInP	Brilliant Red	Water Clear
GC	InGaN	Brilliant Green	
BK	InGaN	Blue	

Technical Data Sheet

Top View LEDs

61-238/RSGCBKC-B02/ET

Package Outline Dimensions

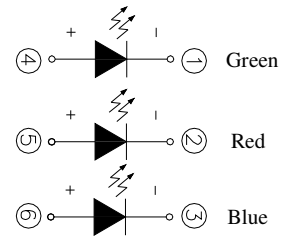
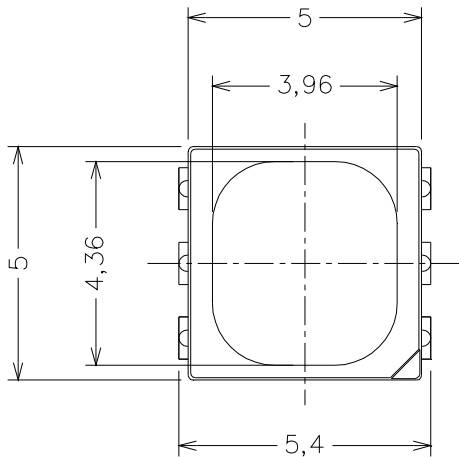

Polarity

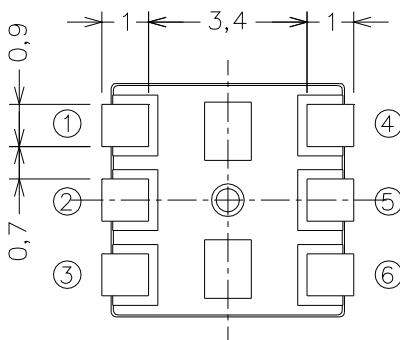
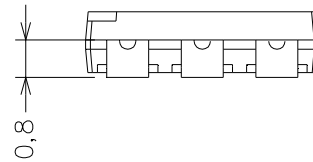
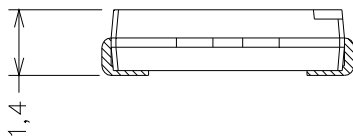

Bot. view

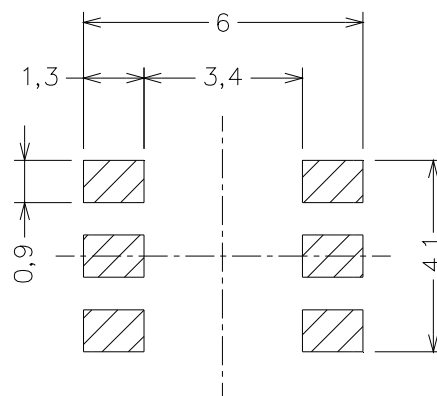

Soldering patterns

Note: The tolerances unless mentioned is ± 0.1 mm; Unit = mm

Technical Data Sheet**Top View LEDs****61-238/RSGCBKC-B02/ET****Absolute Maximum Ratings (Ta=25°C)**

Parameter	Symbol	Rating		Unit
Reverse Voltage	V _R	5		V
Forward Current	I _F	RS	50	mA
		GC	30	
		BK	30	
Peak Forward Current (Duty 1/10 @ 1KHz)	I _{FP}	RS	100	mA
		GC	100	
		BK	100	
Power Dissipation	Pd	RS	120	mW
		GC	110	
		BK	110	
Electrostatic Discharge(HBM)	ESD	1000		V
Operating Temperature	Topr	-40 ~ +85		°C
Storage Temperature	Tstg	-40~ +90		°C
Soldering Temperature	Tsol	Reflow Soldering : 260 °C for 10 sec. Hand Soldering : 350 °C for 3 sec.		

Technical Data Sheet

Top View LEDs

61-238/RSGCBKC-B02/ET

Electro-Optical Characteristics (Ta=25°C)

Parameter	Symbol	Min.	Typ.	Max.	Unit	Condition
Luminous Intensity	I _v	RS	450	-----	900	mcd I _F =20mA
		GC	1120	-----	1800	
		BK	225	-----	450	
Viewing Angle	2θ _{1/2}	-----	120	-----	deg	I _F =20mA
Peak Wavelength	λ _p	RS	-----	632	-----	nm I _F =20mA
		GC	-----	518	-----	
		BK	-----	468	-----	
Dominant Wavelength	λ _d	RS	617.5	-----	629.5	nm I _F =20mA
		GC	520	-----	530	
		BK	465	-----	475	
Spectrum Radiation Bandwidth	Δλ	RS	-----	20	-----	nm I _F =20mA
		GC	-----	35	-----	
		BK	-----	25	-----	
Forward Voltage	V _F	RS	1.75	-----	2.35	V I _F =20mA
		GC	2.75	-----	3.65	
		BK	2.75	-----	3.65	
Reverse Current	I _R	RS	-----	-----	10	μA V _R =5V
		GC	-----	-----	50	
		BK	-----	-----	50	

Notes:

- 1.Tolerance of Luminous Intensity: ±11%
- 2.Tolerance of Dominant Wavelength: ±1 nm
- 3.Tolerance of Forward Voltage: ±0.1V

Technical Data Sheet**Top View LEDs****61-238/RSGCBKC-B02/ET****Bin Range of Luminous Intensity**

Symbol	Bin Code	Min.	Max.	Unit	Condition
RS	U1	450	565	mcd	$I_F=20\text{mA}$
	U2	565	715		
	V1	715	900		
GC	W1	1120	1420		
	W2	1420	1800		
BK	S2	225	285		
	T1	285	360		
	T2	360	450		

Bin Range of Dominant Wavelength

Symbol	Bin Code	Min.	Max.	Unit	Condition
RS	E4	617.5	621.5	nm	$I_F=20\text{mA}$
	E5	621.5	625.5		
	E6	625.5	629.5		
GC	X	520	525		
	Y	525	530		
BK	X	465	470		
	Y	470	475		

Notes:

- 1.Tolerance of Luminous Intensity: $\pm 11\%$
- 2.Tolerance of Dominant Wavelength: $\pm 1\text{ nm}$

Technical Data Sheet

Top View LEDs

61-238/RSGCBKC-B02/ET

Bin Range of Forward Voltage

Symbol	Bin Code	Min.	Max.	Unit	Condition
RS	0	1.75	1.95	V	I _F =20mA
	1	1.95	2.15		
	2	2.15	2.35		
GC	5	2.75	3.05		
	6	3.05	3.35		
	7	3.35	3.65		
BK	5	2.75	3.05		
	6	3.05	3.35		
	7	3.35	3.65		

Note:

Tolerance of Forward Voltage: $\pm 0.1V$

Technical Data Sheet

Top View LEDs

61-238/RSGCBKC-B02/ET

Typical Electro-Optical Characteristics Curves (RS)

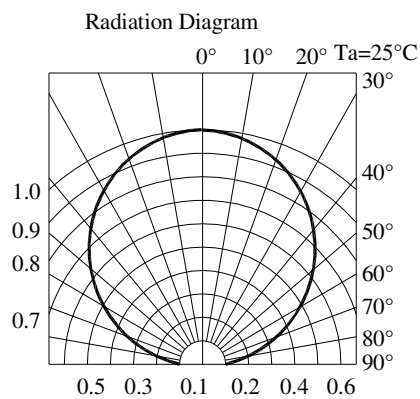
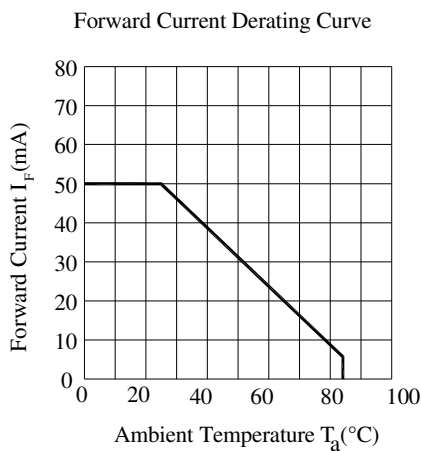
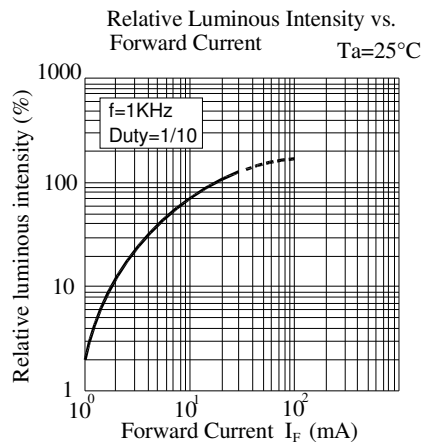
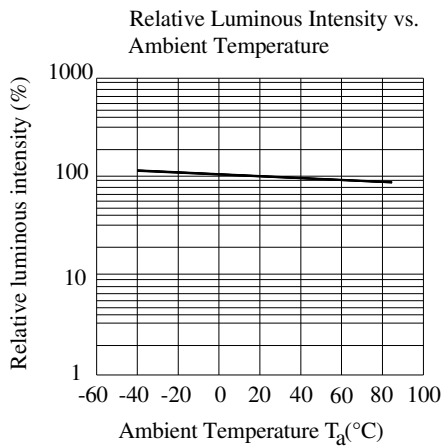
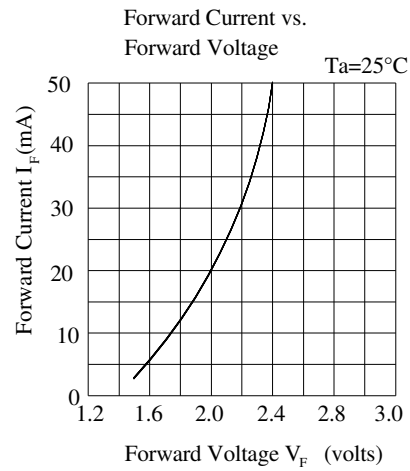
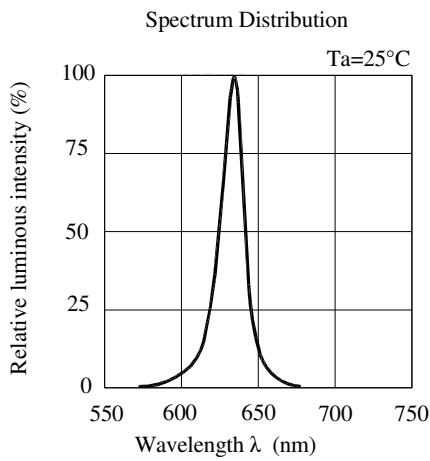

Technical Data Sheet

Top View LEDs

61-238/RSGCBKC-B02/ET

Typical Electro-Optical Characteristics Curves (GC)

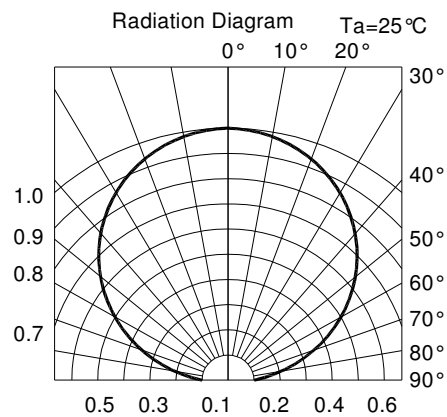
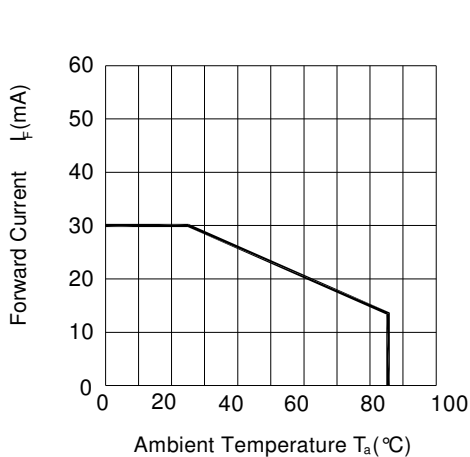
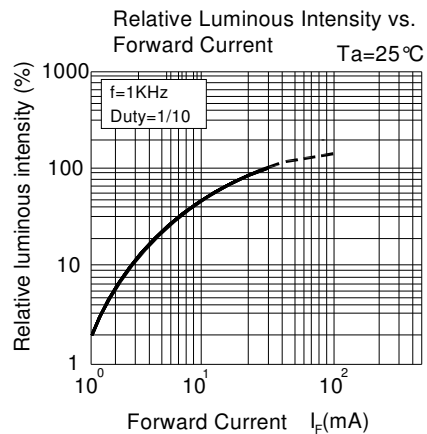
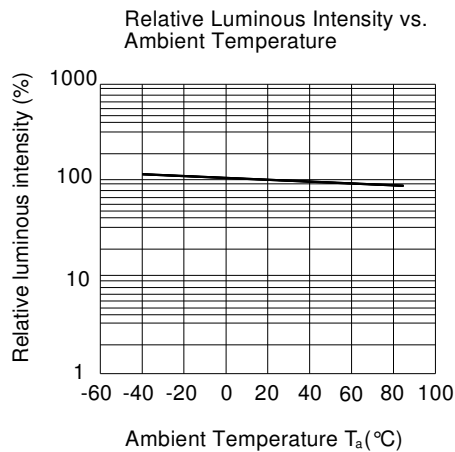
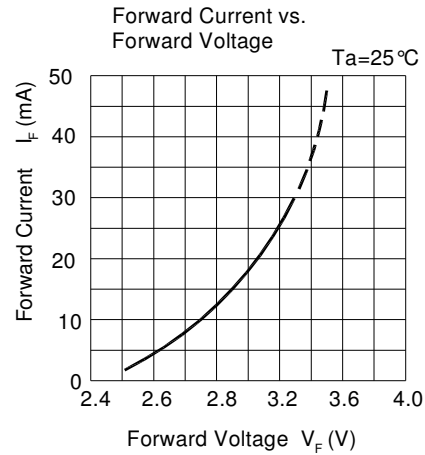
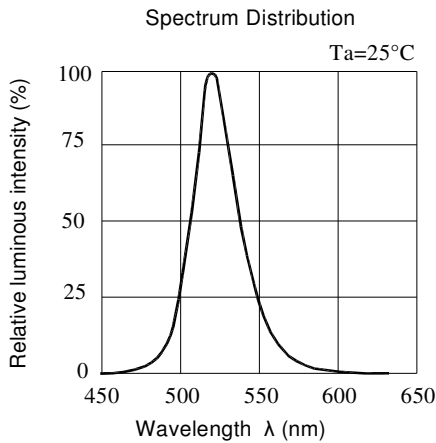

Technical Data Sheet

Top View LEDs

61-238/RSGCBKC-B02/ET

Typical Electro-Optical Characteristics Curves (BK)

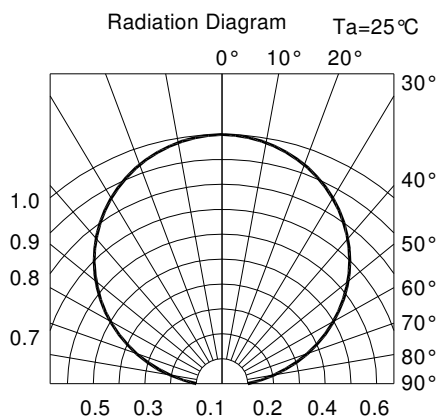
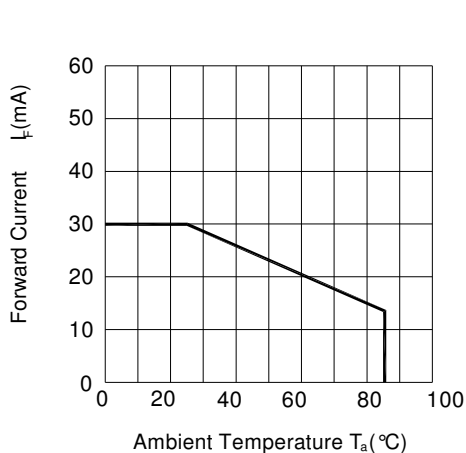
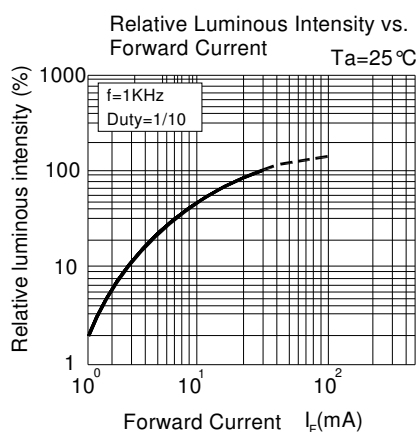
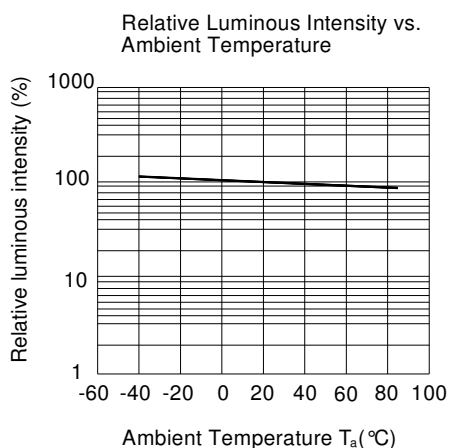
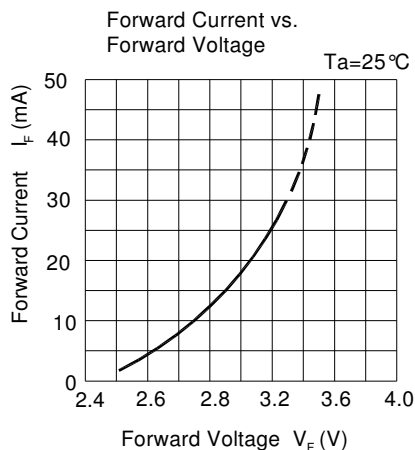
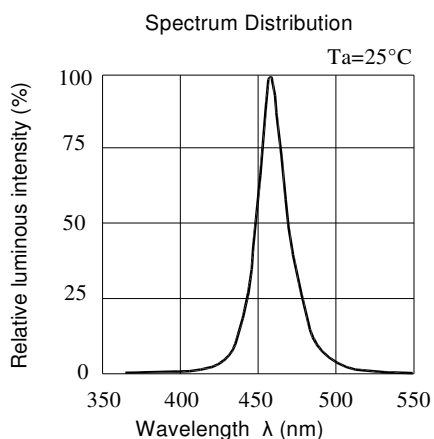

Technical Data Sheet

Top View LEDs

61-238/RSGCBKC-B02/ET

Label Explanation

CAT: Luminous Intensity Rank

HUE: Dom. Wavelength Rank

REF: Forward Voltage Rank

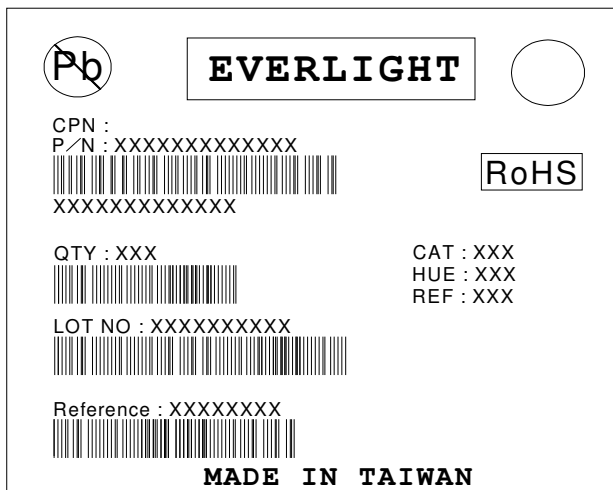

Reel Dimensions

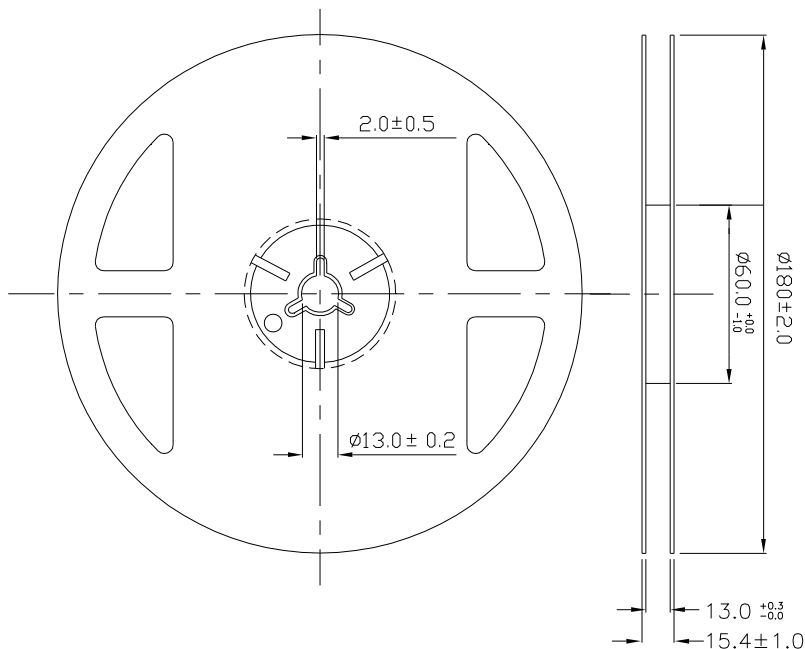

Note: Tolerance unless mentioned is ± 0.1 mm; Unit = mm

Technical Data Sheet

Top View LEDs

61-238/RSGCBKC-B02/ET

Carrier Tape Dimensions: Loaded Quantity 800 pcs Per Reel

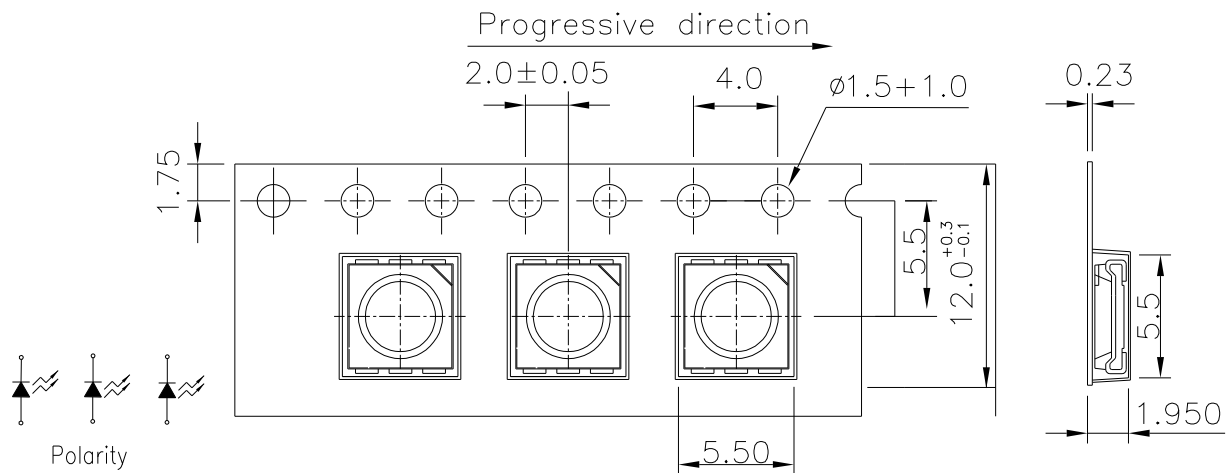

Note: Tolerances unless mentioned is ± 0.1 mm; Unit = mm

Moisture Resistant Packaging

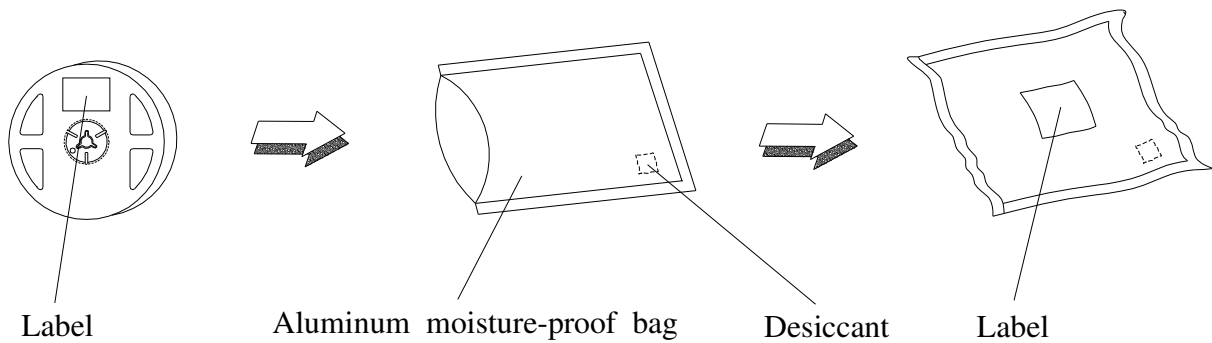

Technical Data Sheet**Top View LEDs****61-238/RSGCBKC-B02/ET****Reliability Test Items and Conditions**

The reliability of products shall be satisfied with items listed below.

Confidence level : 90%

LTPD : 10%

No.	Items	Test Condition	Test Hours/Cycles	Sample Size	Ac/Re
1	Reflow Soldering	Temp. : 260°C±5°C Max. 10 sec.	6 Min.	22 PCS.	0/1
2	Temperature Cycle	H : +100°C 15min ∫ 5 min L : -40°C 15min	300 Cycles	22 PCS.	0/1
3	Thermal Shock	H : +100°C 5min ∫ 10 sec L : -10°C 5min	300 Cycles	22 PCS.	0/1
4	High Temperature Storage	Temp. : 100°C	1000 Hrs.	22 PCS.	0/1
5	Low Temperature Storage	Temp. : -40°C	1000 Hrs.	22 PCS.	0/1
6	DC Operating Life	I _F = 20 mA	1000 Hrs.	22 PCS.	0/1
7	High Temperature / High Humidity	85°C / 85%RH	1000 Hrs.	22 PCS.	0/1

Technical Data Sheet

Top View LEDs

61-238/RSGCBKC-B02/ET

Precautions for Use

1. Over-current-proof

Customer must apply resistors for protection, otherwise slight voltage shift will cause big current change (Burn out will happen).

2. Storage

2.1 Do not open moisture proof bag before the products are ready to use.

2.2 Before opening the package: The LEDs should be kept at 30°C or less and 90%RH or less.

2.3 After opening the package: The LED's floor life is 168 hours under 30°C or less and 60% RH or less.

If unused LEDs remain, it should be stored in moisture proof packages.

2.4 If the moisture absorbent material (silica gel) has faded away or the LEDs have exceeded the storage time, baking treatment should be performed using the following conditions.

Baking treatment : 60±5°C for 24 hours.

3. Soldering Condition

3.1 Pb-free solder temperature profile

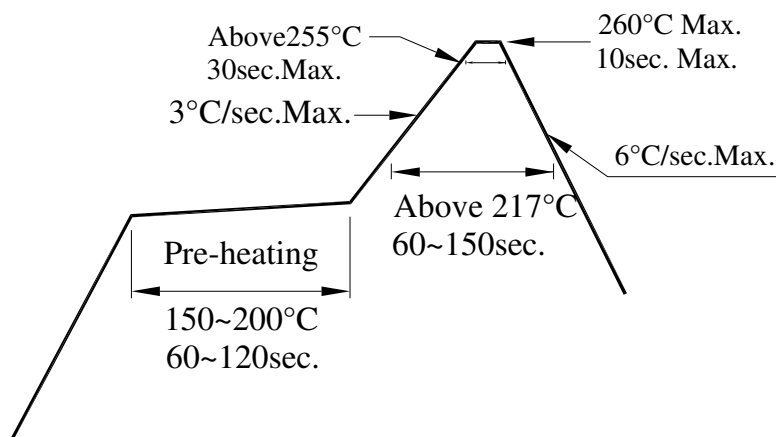

3.2 Reflow soldering should not be done more than two times.

3.3 When soldering, do not put stress on the LEDs during heating.

3.4 After soldering, do not warp the circuit board.

Technical Data Sheet

Top View LEDs

61-238/RSGCBKC-B02/ET

4. Soldering Iron

Each terminal is to go to the tip of soldering iron temperature less than 350°C for 3 seconds within once in less than the soldering iron capacity 25W. Leave two seconds and more intervals, and do soldering of each terminal. Be careful because the damage of the product is often started at the time of the hand solder.

5. Repairing

Repair should not be done after the LEDs have been soldered. When repairing is unavoidable, a double-head soldering iron should be used (as below figure). It should be confirmed beforehand whether the characteristics of the LEDs will or will not be damaged by repairing.

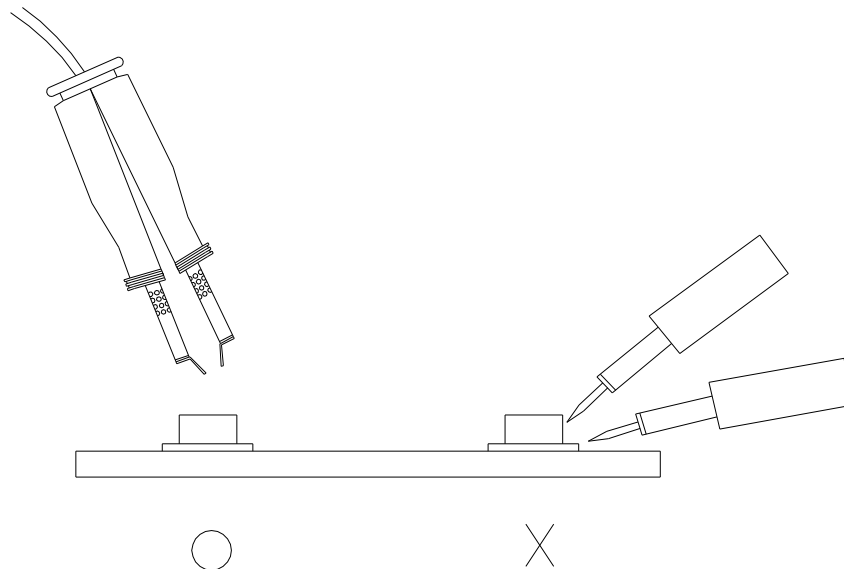

EVERLIGHT ELECTRONICS CO., LTD.
Office: No 25, Lane 76, Sec 3, Chung Yang Rd,
Tucheng, Taipei 236, Taiwan, R.O.C

Tel: 886-2-2267-2000, 2267-9936
Fax: 886-2267-6244, 2267-6189, 2267-6306
<http://www.everlight.com>