

Description

The 6706A uses advanced trench technology and design to provide excellent $R_{DS(ON)}$ with low gate charge. It can be used to form a level shifted high side switch, and a wide variety of applications.

General Features

● N-Channel

V_{DSS}	$R_{DS(ON)}$ @ 10V (typ)	I_D
30V	20 mΩ	6.5A

● P-Channel

V_{DSS}	$R_{DS(ON)}$ @ 10V (typ)	I_D
-30V	42 mΩ	-5 A

- High power and current handing capability
- RoHS Compliant

Application

- PWM applications
- Load switch
- Power management

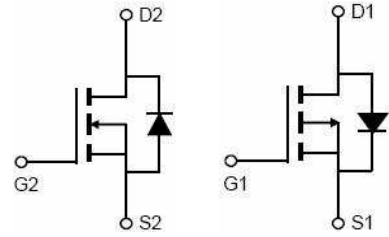

N-channel P-channel

Schematic diagram

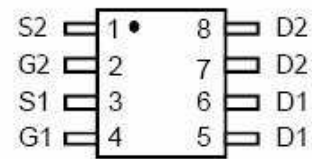

Marking and pin assignment

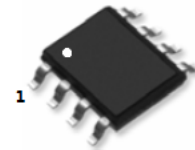

SOP-8

Ordering Information

Part Number	Marking	Case	Packaging
6706A	6706A	SOP-8	4000pcs/Reel

Absolute Maximum Ratings ($T_A=25^\circ\text{C}$ unless otherwise noted)

Parameter	Symbol	N-Channel	P-Channel	Unit
Drain-Source Voltage	V_{DS}	30	-30	V
Gate-Source Voltage	V_{GS}	± 20	± 20	V
Drain Current-Continuous	I_D	$T_A=25^\circ\text{C}$	-5	A
		$T_A=70^\circ\text{C}$	-4.1	A
Drain Current-Pulsed (Note 1)	I_{DM}	26	-20	A
Maximum Power Dissipation	P_D	2.0	2.0	W
Operating Junction and Storage Temperature Range	T_J, T_{STG}	-55 To 150	-55 To 150	$^\circ\text{C}$

Thermal Characteristic

Thermal Resistance, Junction-to-Ambient (Note 2)	$R_{\theta JA}$	N-Ch	62.5	$^\circ\text{C/W}$
Thermal Resistance, Junction-to-Ambient (Note 2)	$R_{\theta JA}$	P-Ch	62.5	$^\circ\text{C/W}$

N-CH Electrical Characteristics (T_A=25°C unless otherwise noted)

Parameter	Symbol	Condition	Min	Typ	Max	Unit
Off Characteristics						
Drain-Source Breakdown Voltage	BV _{DSS}	V _{GS} =0V I _D =250μA	30	33	-	V
Zero Gate Voltage Drain Current	I _{DSS}	V _{DS} =30V, V _{GS} =0V	-	-	1	μA
Gate-Body Leakage Current	I _{GSS}	V _{GS} =±20V, V _{DS} =0V	-	-	±100	nA
On Characteristics (Note 3)						
Gate Threshold Voltage	V _{GS(th)}	V _{DS} =V _{GS} , I _D =250μA	1.2	1.6	2.4	V
Drain-Source On-State Resistance	R _{DS(ON)}	V _{GS} =10V, I _D =5A	-	20	30	mΩ
Drain-Source On-State Resistance	R _{DS(ON)}	V _{GS} =4.5V, I _D =5A	-	30	40	mΩ
Forward Transconductance	g _{FS}	V _{DS} =5V, I _D =5A	-	15	-	S
Dynamic Characteristics (Note 4)						
Input Capacitance	C _{iss}	V _{DS} =15V, V _{GS} =0V, F=1.0MHz	-	255	-	PF
Output Capacitance	C _{oss}		-	45	-	PF
Reverse Transfer Capacitance	C _{rss}		-	35	-	PF
Switching Characteristics (Note 4)						
Turn-on Delay Time	t _{d(on)}	V _{DD} =15V, R _L =2.5Ω V _{GS} =10V, R _G =3Ω	-	4.5	-	nS
Turn-on Rise Time	t _r		-	2.5	-	nS
Turn-Off Delay Time	t _{d(off)}		-	14.5	-	nS
Turn-Off Fall Time	t _f		-	3.5	-	nS
Total Gate Charge	Q _g	V _{DS} =15V, I _D =5A, V _{GS} =10V	-	5.2	-	nC
Gate-Source Charge	Q _{gs}		-	0.85	-	nC
Gate-Drain Charge	Q _{gd}		-	1.3	-	nC
Drain-Source Diode Characteristics						
Diode Forward Voltage (Note 3)	V _{SD}	V _{GS} =0V, I _S =5A	-	-	1.2	V

P-CH Electrical Characteristics (T_A=25°C unless otherwise noted)

Parameter	Symbol	Condition	Min	Typ	Max	Unit
Off Characteristics						
Drain-Source Breakdown Voltage	BV _{DSS}	V _{GS} =0V, I _D =-250μA	-30	-33	-	V
Zero Gate Voltage Drain Current	I _{DSS}	V _{DS} =-30V, V _{GS} =0V	-	-	-1	μA
Gate-Body Leakage Current	I _{GSS}	V _{GS} =±20V, V _{DS} =0V	-	-	±100	nA
On Characteristics (Note 3)						
Gate Threshold Voltage	V _{GS(th)}	V _{DS} =V _{GS} , I _D =-250μA	-1	-1.6	-2.5	V
Drain-Source On-State Resistance	R _{DS(ON)}	V _{GS} =-10V, I _D =-4A	-	42	60	mΩ
Drain-Source On-State Resistance	R _{DS(ON)}	V _{GS} =-4.5V, I _D =-4A	-	62	90	mΩ
Forward Transconductance	g _{FS}	V _{DS} =-5V, I _D =-5A	-	8	-	S
Dynamic Characteristics (Note 4)						
Input Capacitance	C _{ISS}	V _{DS} =-15V, V _{GS} =0V, F=1.0MHz	-	520	-	PF
Output Capacitance	C _{OSS}		-	100	-	PF
Reverse Transfer Capacitance	C _{RSS}		-	65	-	PF
Switching Characteristics (Note 4)						
Turn-on Delay Time	t _{d(on)}	V _{DD} =-15V, R _L =2.3Ω V _{GS} =-10V, R _G =6Ω	-	7.5	-	nS
Turn-on Rise Time	t _r		-	5.5	-	nS
Turn-Off Delay Time	t _{d(off)}		-	19	-	nS
Turn-Off Fall Time	t _f		-	7	-	nS
Total Gate Charge	Q _g	V _{DS} =-15V, I _D =-5A, V _{GS} =-10V	-	9.2	-	nC
Gate-Source Charge	Q _{gs}		-	1.6	-	nC
Gate-Drain Charge	Q _{gd}		-	2.2	-	nC
Drain-Source Diode Characteristics						
Diode Forward Voltage (Note 3)	V _{SD}	V _{GS} =0V, I _S =-5A	-	-	-1.2	V

Notes:

1. Repetitive Rating: Pulse width limited by maximum junction temperature.
2. Surface Mounted on FR4 Board, t ≤ 10 sec.
3. Pulse Test: Pulse Width ≤ 300μs, Duty Cycle ≤ 2%.

N-Channel Typical Electrical and Thermal Characteristics (Curves)

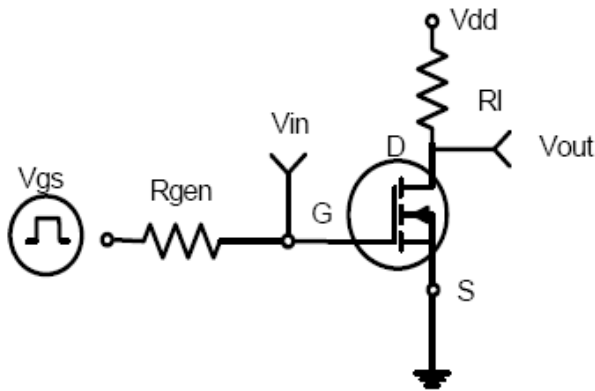

Figure 1 Switching Test Circuit

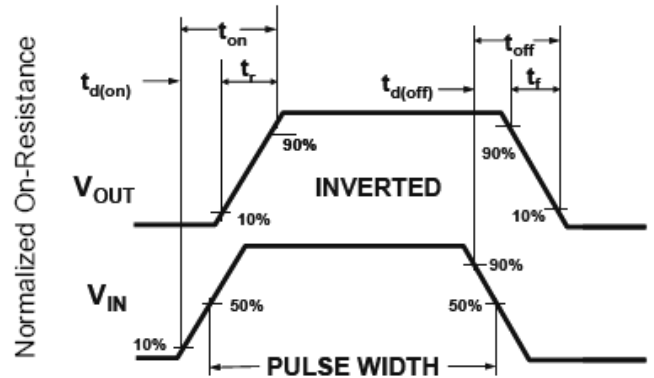

Figure 2 Switching Waveforms

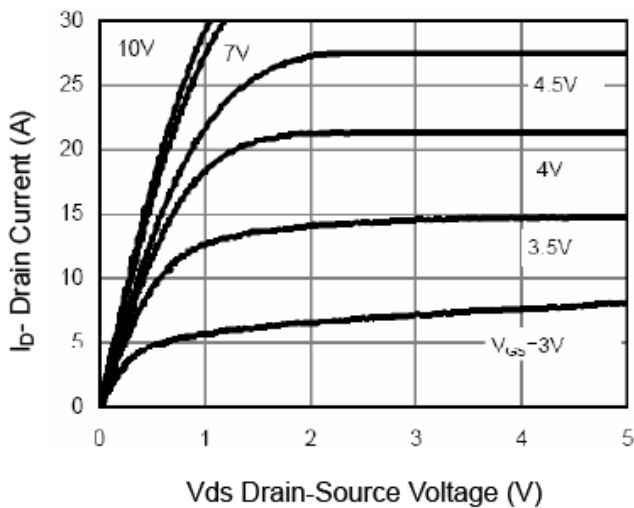

Figure 3 Output Characteristics

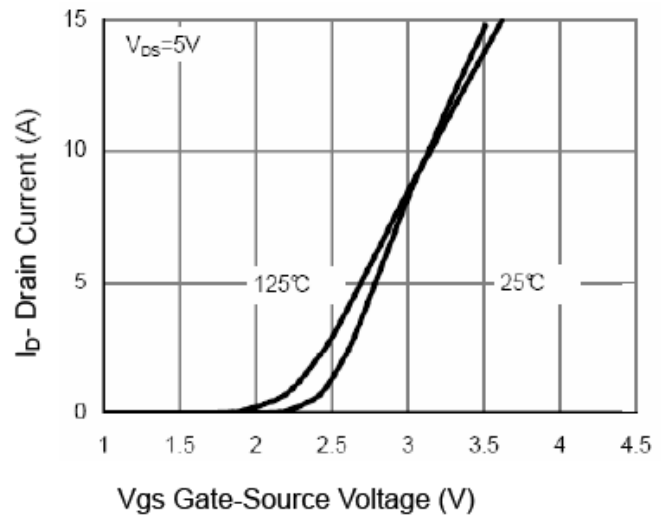

Figure 4 Transfer Characteristics

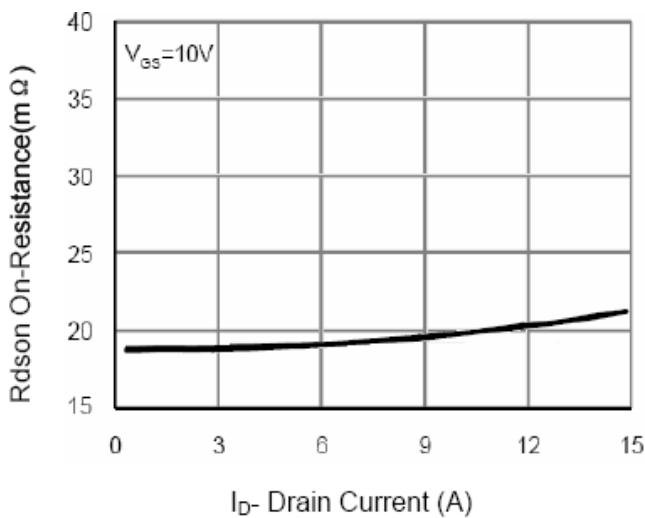

Figure 5 Rdson- Drain Current

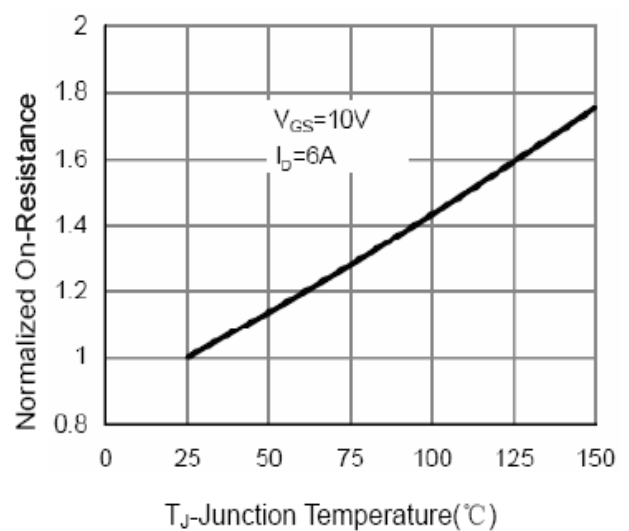

Figure 6 Source- Drain Diode Forward

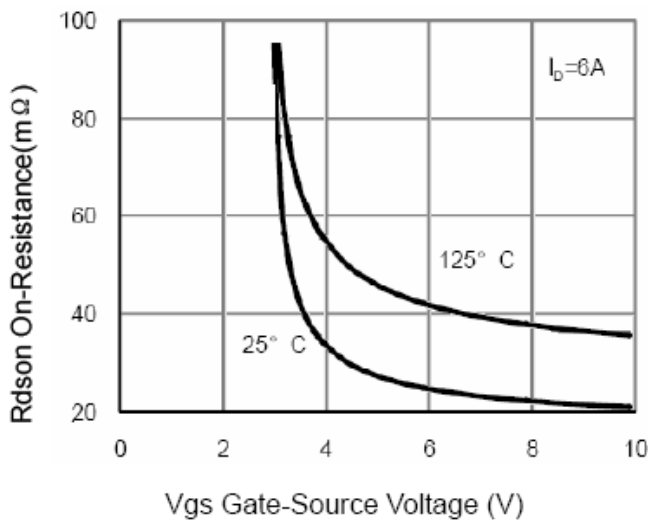

Figure 7 Rdson vs Vgs

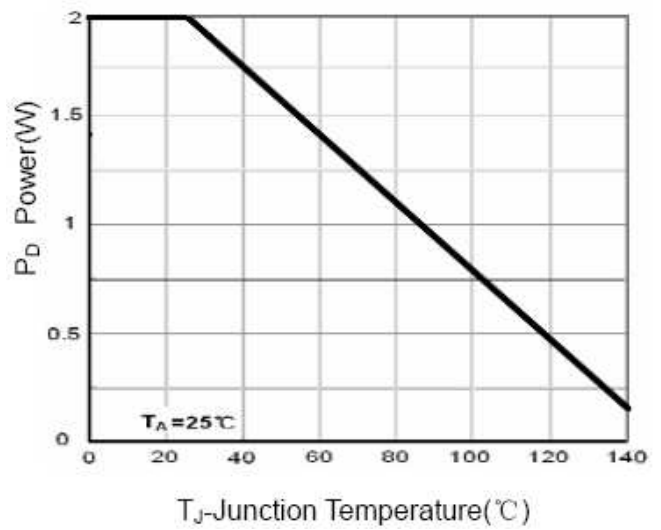

Figure 8 Power Dissipation

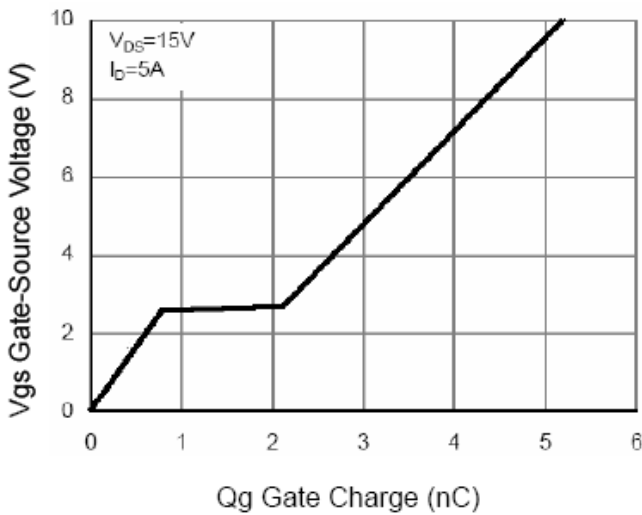

Figure 8 Gate Charge

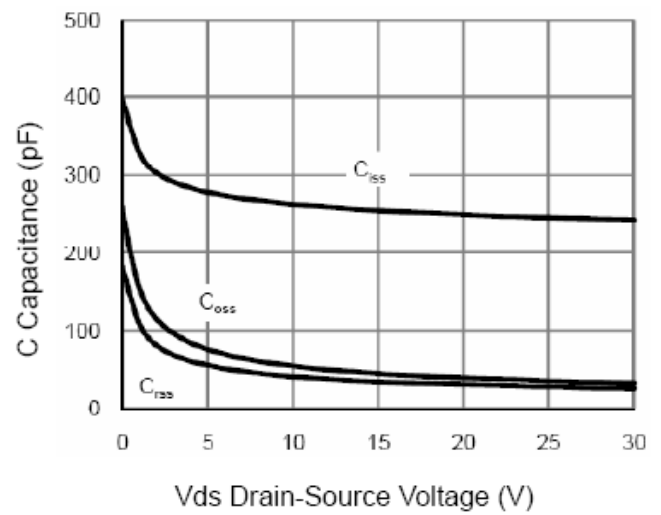

Figure 9 Capacitance vs Vds

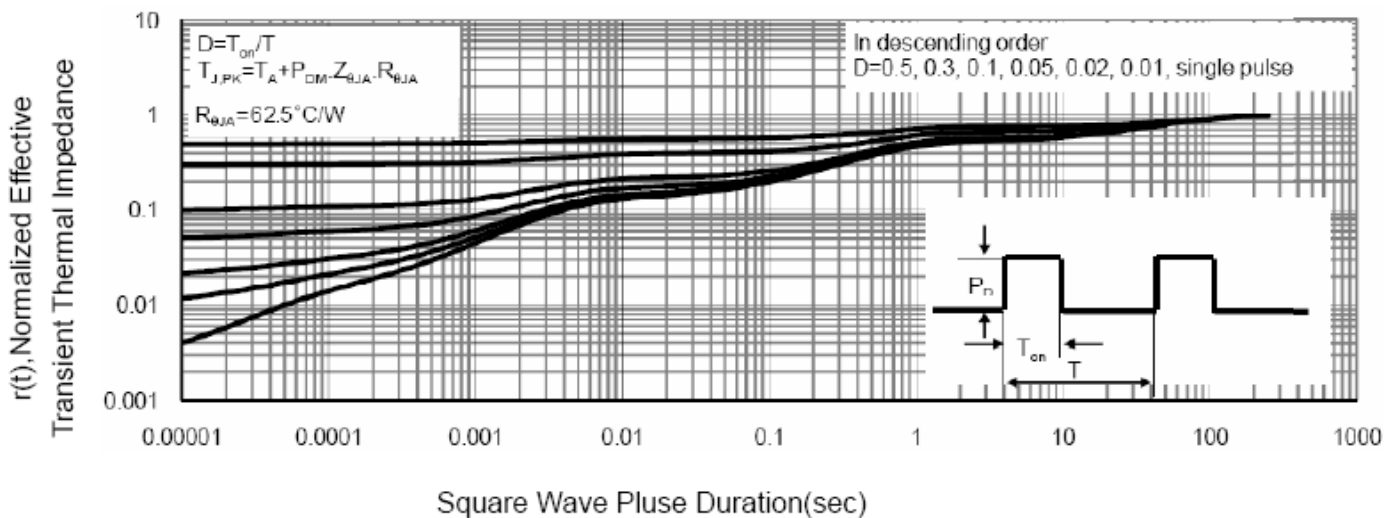

Figure 10 Normalized Maximum Transient Thermal Impedance

P-Channel Typical Electrical and Thermal Characteristics (Curves)

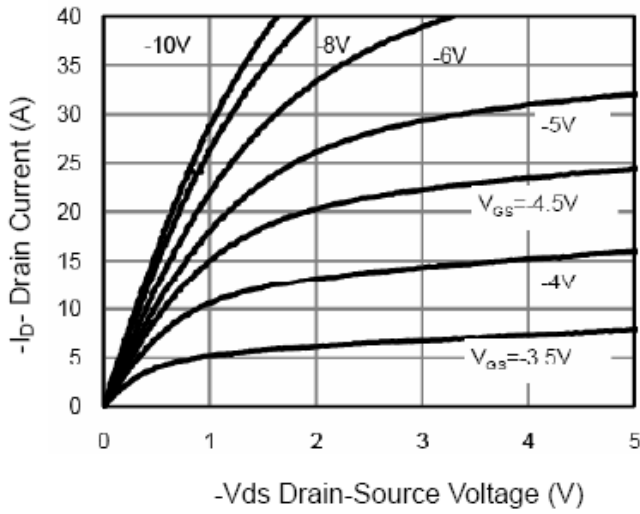

Figure 1 Output Characteristics

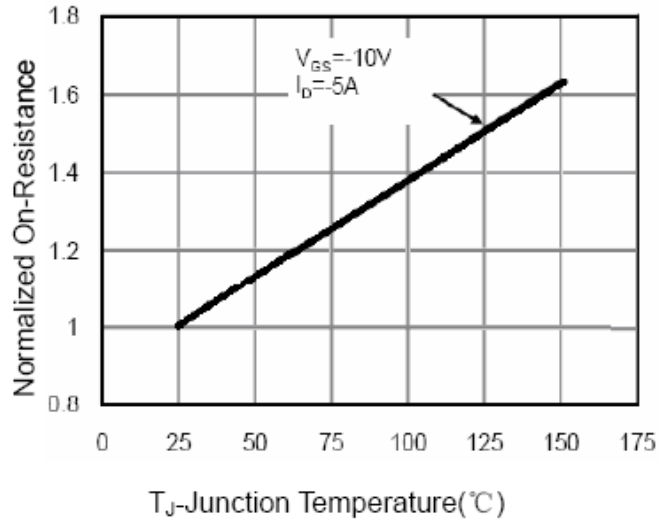

Figure 2 R_{dson} -Junction Temperature

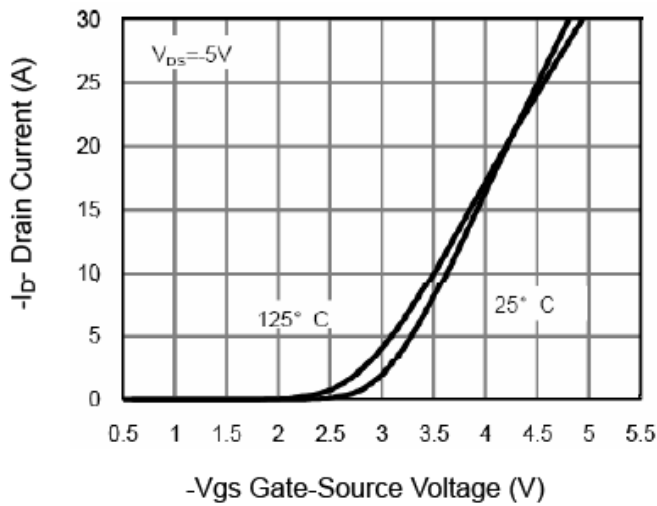

Figure 3 Transfer Characteristics

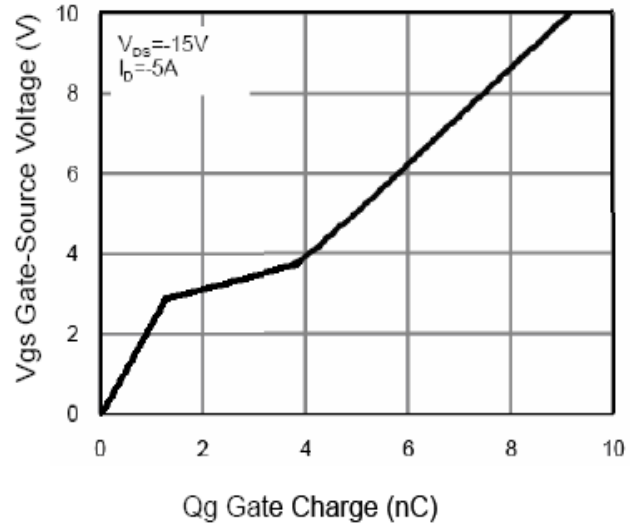

Figure 4 Gate Charge

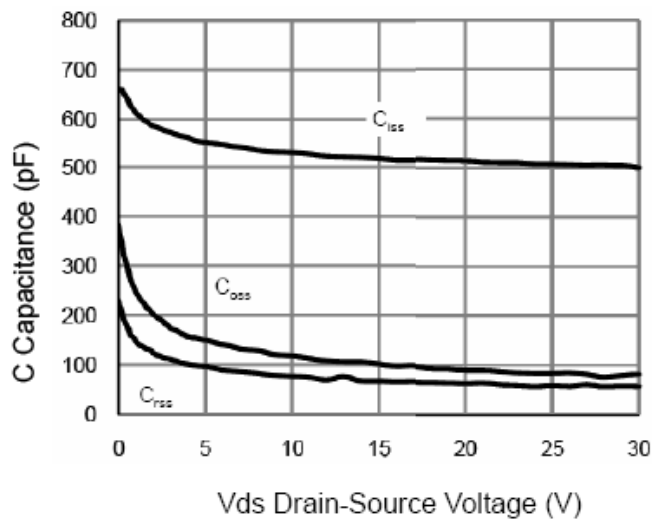

Figure 5 Capacitance vs V_{ds}

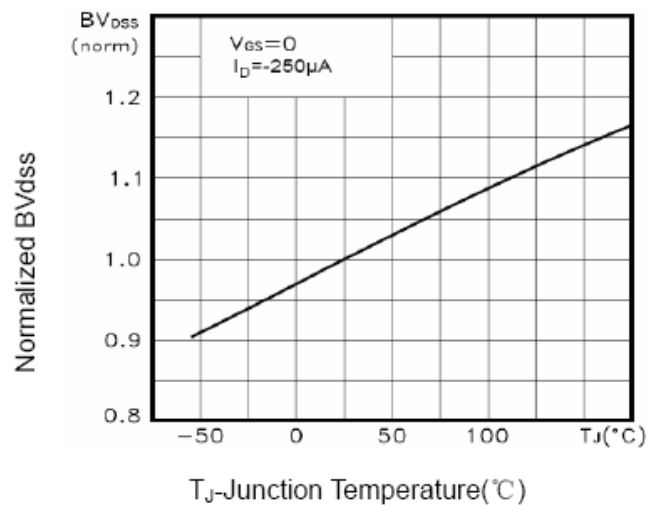

Figure 6 BV_{dss} vs Junction Temperature

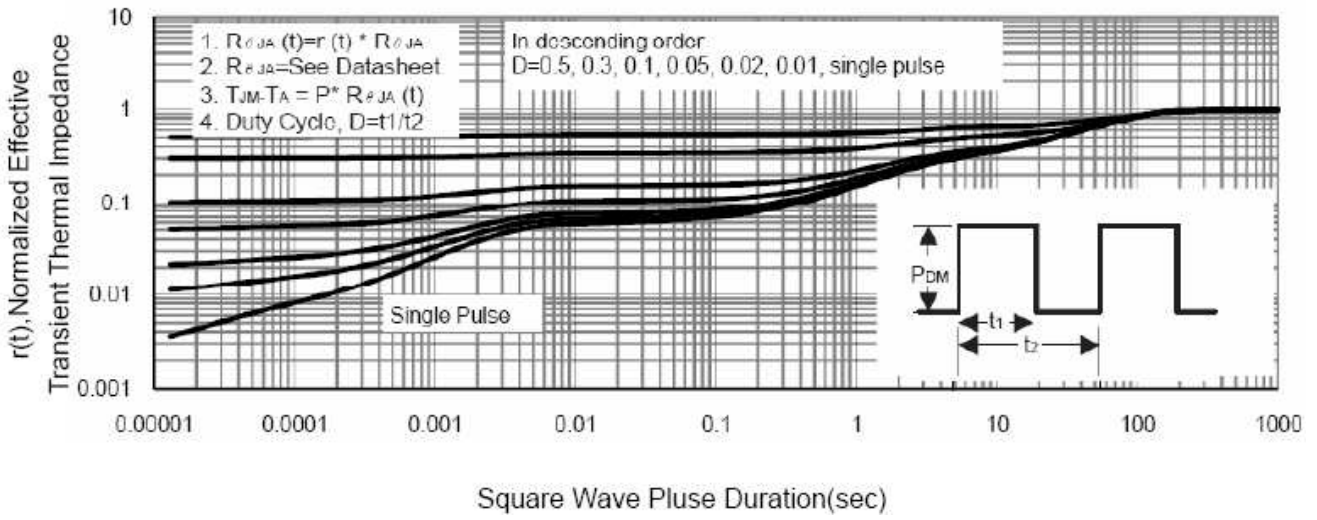
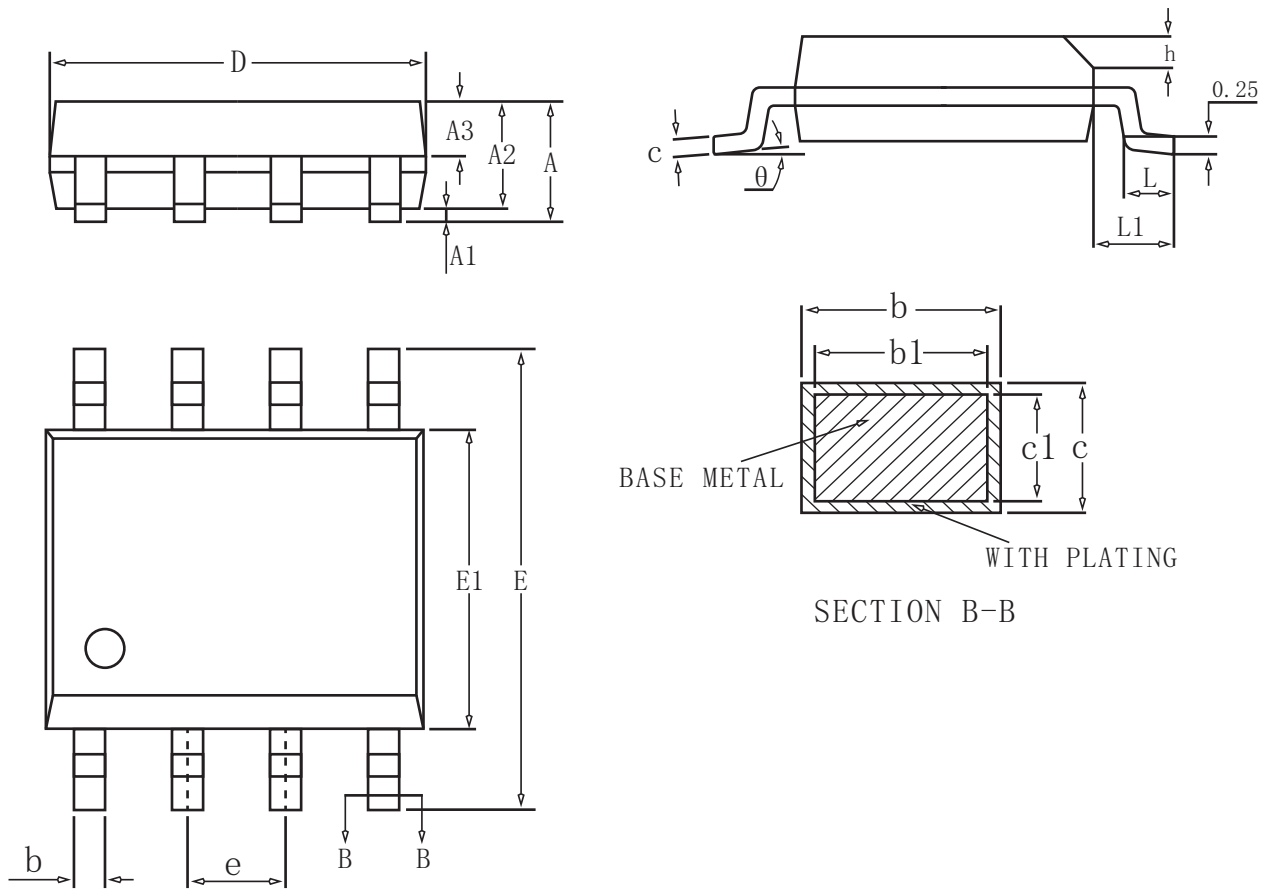

Figure 7 Normalized Maximum Transient Thermal Impedance

Package information



SYMBOL	MILLIMETER		
	MIN	NOM	MAX
A	-	-	1.75
A1	0.10	-	0.225
A2	1.30	1.40	1.50
A3	0.60	0.65	0.70
b	0.39	-	0.47
b1	0.38	0.41	0.44
c	0.20	-	0.24
c1	0.19	0.20	0.21
D	4.80	4.90	5.00
E	5.80	6.00	6.20
E1	3.80	3.90	4.00
e	1.27BSC		
h	0.25	-	0.50
L	0.50	-	0.80
L1	1.05REF		
θ	0	-	8°