



DISSIMILAR-DOUBLE-TRIODE PENTODE

DESCRIPTION AND RATING

The 6AF11 is a compactron containing a high- μ triode, a medium- μ triode, and a sharp-cutoff pentode. The high- μ triode is intended for AGC keyer service, the low- μ triode for sync separator service, and the pentode for video amplifier service in television receivers.

GENERAL

ELECTRICAL

Cathode—Coated Unipotential	
Heater Characteristics and Ratings	
Heater Voltage, AC or DC*	6.3 \pm 0.6 Volts
Heater Current†	1.05 Amperes
Direct Interelectrode Capacitances‡	
Triode (Section 1)	
Grid to Plate: (T1g to T1p)	1.9 pf
Input: T1g to (T1k+T2k+Pk+Pg3+h+i.s.)	3.0 pf
Output: T1p to (T1k+T2k+Pk+Pg3+h+i.s.)	2.2 pf
Triode (Section 2)	
Grid to Plate: (T2g to T2p)	3.6 pf
Input: T2g to (T2k+Pk+Pg3+h+i.s.)	2.4 pf
Output: T2p to (T2k+Pk+Pg3+h+i.s.)	3.8 pf
Pentode	
Grid-Number 1 to Plate: (Pg1 to Pp)	0.12 pf
Input: Pg1 to (T2k+Pk+Pg2+Pg3+h+i.s.)	10 pf
Output: Pp to (T2k+Pk+Pg2+Pg3+h+i.s.)	4.5 pf
Pentode Plate to Triode Plate (Section 2):	
(Pp to T2p), maximum	0.045 pf
Triode Plate (Section 1) to Triode Plate (Section 2):	
(T1p to T2p), maximum	0.06 pf

MECHANICAL

Mounting Position—Any	
Envelope—T-9, Glass	
Base—E12-70, Button 12-Pin	
Outline Drawing—EIA 9-58	
Maximum Diameter	1.188 Inches
Maximum Over-all Length	2.375 Inches
Maximum Seated Height	2.000 Inches

PHYSICAL DIMENSIONS

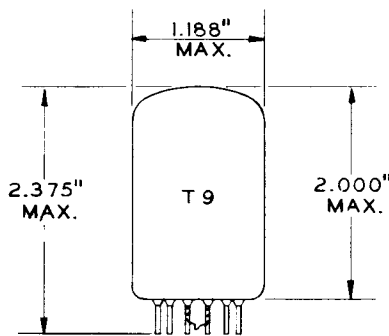

EIA 9-58

TERMINAL CONNECTIONS

- Pin 1—Heater
- Pin 2—Pentode Plate
- Pin 3—Triode Grid (Section 2)
- Pin 4—Triode Plate (Section 2)
- Pin 5—Triode Cathode (Section 1)
- Pin 6—Triode Grid (Section 1)
- Pin 7—Triode Cathode and Internal Shield (Section 2)
- Pin 8—Triode Plate (Section 1)
- Pin 9—Pentode Cathode, Grid Number 3, and Internal Shield
- Pin 10—Pentode Grid Number 2 (Screen)
- Pin 11—Pentode Grid Number 1
- Pin 12—Heater

BASING DIAGRAM

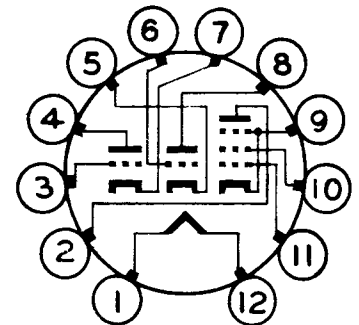

EIA 12DP

MAXIMUM RATINGS

DESIGN-MAXIMUM VALUES

Pentode Section

Plate Voltage	330	Volts
Screen-Supply Voltage	330	Volts
Screen Voltage—See Screen Rating Chart		
Positive DC Grid-Number 1 Voltage	0	Volts
Plate Dissipation	5.0	Watts
Screen Dissipation	1.25	Watts

Heater-Cathode Voltage		
Heater Positive with Respect to Cathode		
DC Component	100	Volts
Total DC and Peak	200	Volts
Heater Negative with Respect to Cathode		
Total DC and Peak	200	Volts
Grid-Number 1 Circuit Resistance		
With Fixed Bias	0.25	Megohms
With Cathode Bias	1.0	Megohms

Triode (Section 1)

Plate Voltage	330	Volts
Positive DC Grid Voltage	0	Volts
Plate Dissipation	1.1	Watts
Heater-Cathode Voltage		
Heater Positive with Respect to Cathode		
DC Component	100	Volts
Total DC and Peak	200	Volts
Heater Negative with Respect to Cathode		
Total DC and Peak	200	Volts
Grid Circuit Resistance		
With Fixed Bias	0.5	Megohms
With Cathode Bias	1.0	Megohms

Triode (Section 2)

Plate Voltage	330	Volts
Positive DC Grid Voltage	0	Volts
Plate Dissipation	2.0	Watts
Heater-Cathode Voltage		
Heater Positive with Resepect to Cathode		
DC Component	100	Volts
Total DC and Peak	200	Volts
Heater Negative with Respect to Cathode		
Total DC and Peak	200	Volts
Grid Circuit Resistance		
With Fixed Bias	0.5	Megohms
With Cathode Bias	1.0	Megohms

Design-Maximum ratings are limiting values of operating and environmental conditions applicable to a bogey electron tube of a specified type as defined by its published data and should not be exceeded under the worst probable conditions.

The tube manufacturer chooses these values to provide acceptable serviceability of the tube, making allowance for the effects of changes in operating conditions due to variations in the characteristics of the tube under consideration.

The equipment manufacturer should design so that initially and throughout life no design-maximum value for the intended service is exceeded with a bogey tube under the worst probable operating conditions with respect to supply-voltage variation, equipment component variation, equipment control adjustment, load variation, signal variation, environmental conditions, and variations in the characteristics of all other electron devices in the equipment.

CHARACTERISTICS AND TYPICAL OPERATION

AVERAGE CHARACTERISTICS

Pentode Section

Plate Voltage	50	200	Volts
Screen Voltage	150	150	Volts
Grid-Number 1 Voltage	0		Volts
Cathode-Bias Resistor		100	Ohms
Plate Resistance, approximate		68000	Ohms
Transconductance		11000	Micromhos
Plate Current	55	24	Milliamperes
Screen Current	18	4.8	Milliamperes
Grid-Number 1 Voltage, approximate			
I _b = 100 Microamperes		-10	Volts

The tubes and arrangements disclosed herein may be covered by patents of General Electric Company or others. Neither the disclosure of any information herein nor the sale of tubes by General Electric Company conveys any license under patent claims covering combinations of tubes with other devices or

elements. In the absence of an express written agreement to the contrary, General Electric Company assumes no liability for patent infringement arising out of any use of the tubes with other devices or elements by any purchaser of tubes or others.

CHARACTERISTICS AND TYPICAL OPERATION (Continued)

Triode (Section 1)

Plate Voltage	200	Volts
Grid Voltage	-2.0	Volts
Amplification Factor	68	
Plate Resistance, approximate	12400	Ohms
Transconductance	5500	Micromhos
Plate Current	7.0	Milliamperes
Grid Voltage, approximate I _b = 10 Microamperes	-5.5	Volts

Triode (Section 2)

Plate Voltage	200	Volts
Cathode-Bias Resistor	220	Ohms
Amplification Factor	41	
Plate Resistance, approximate	9400	Ohms
Transconductance	4400	Micromhos
Plate Current	9.2	Milliamperes
Grid Voltage, approximate I _b = 100 Microamperes	-6.5	Volts

- * The equipment designer should design the equipment so that heater voltage is centered at the specified bogey value, with heater supply variations restricted to maintain heater voltage within the specified tolerance.
- † Heater current of a bogey tube at E_f = 6.3 volts.
- ‡ Without external shield.

AVERAGE PLATE CHARACTERISTICS

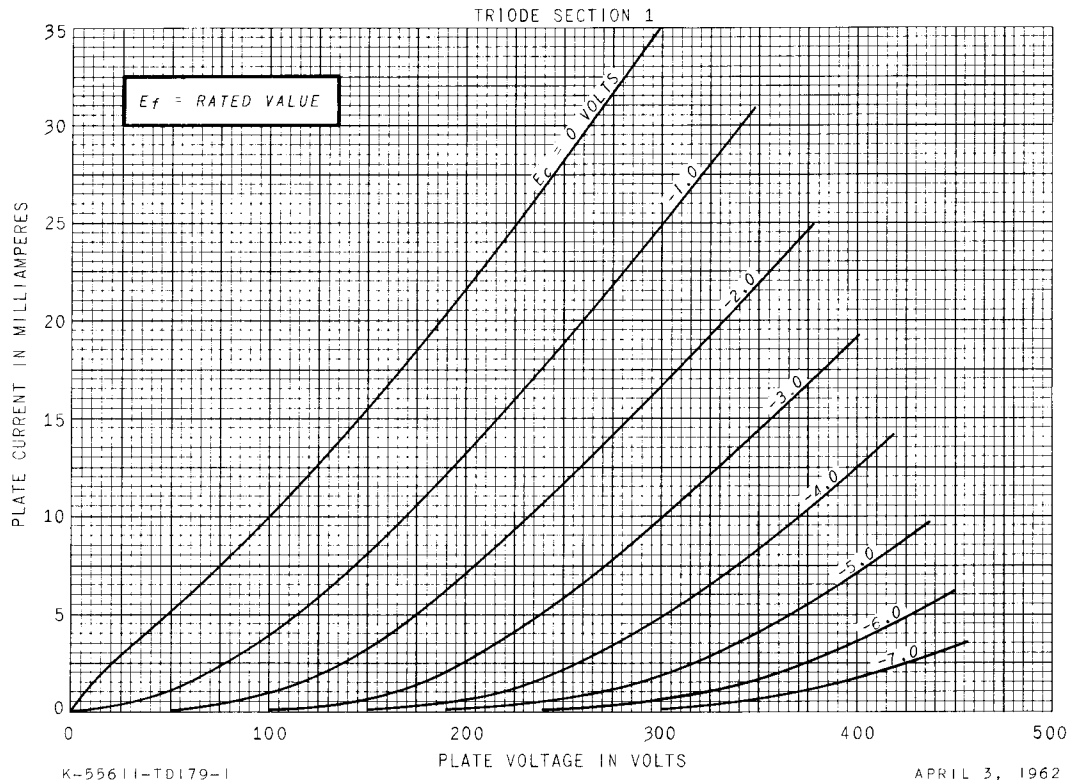

AVERAGE TRANSFER CHARACTERISTICS

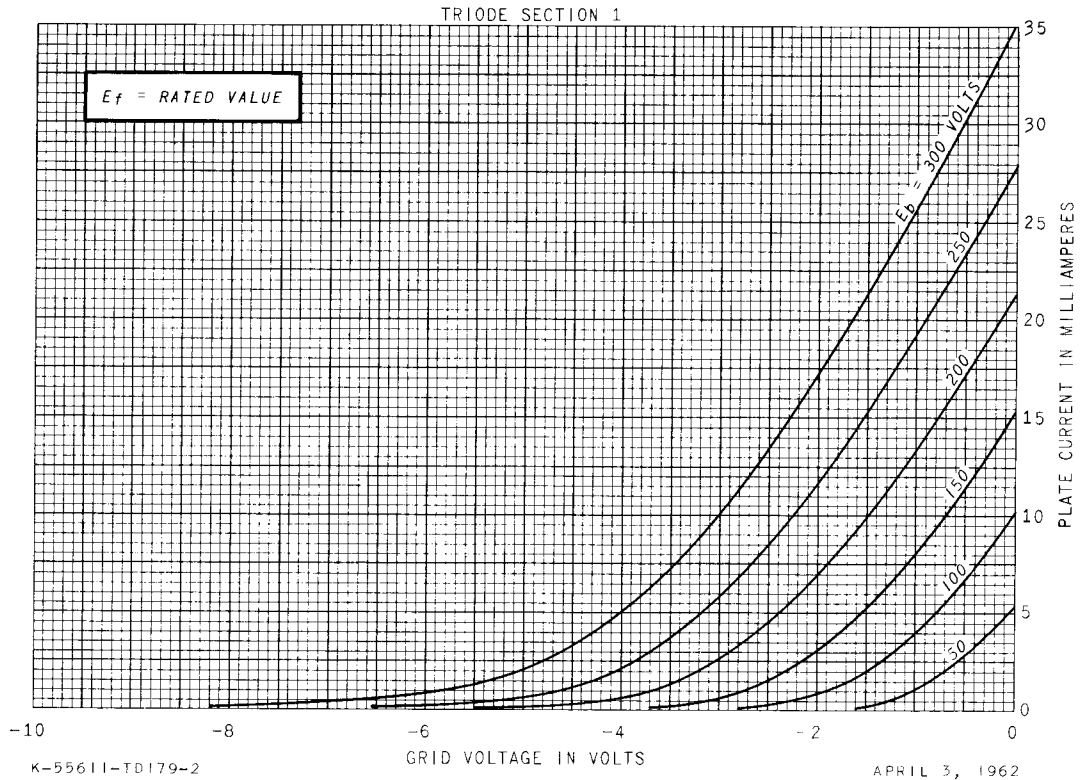

AVERAGE CHARACTERISTICS

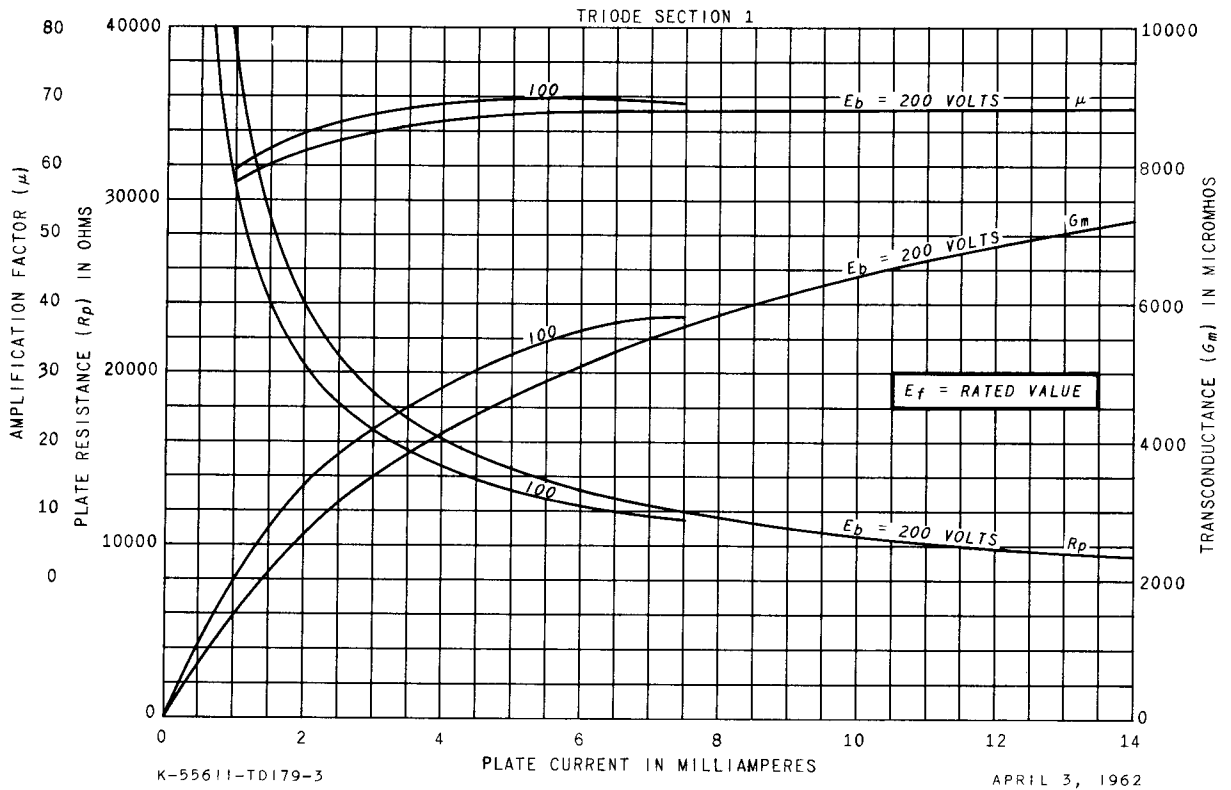

AVERAGE PLATE CHARACTERISTICS

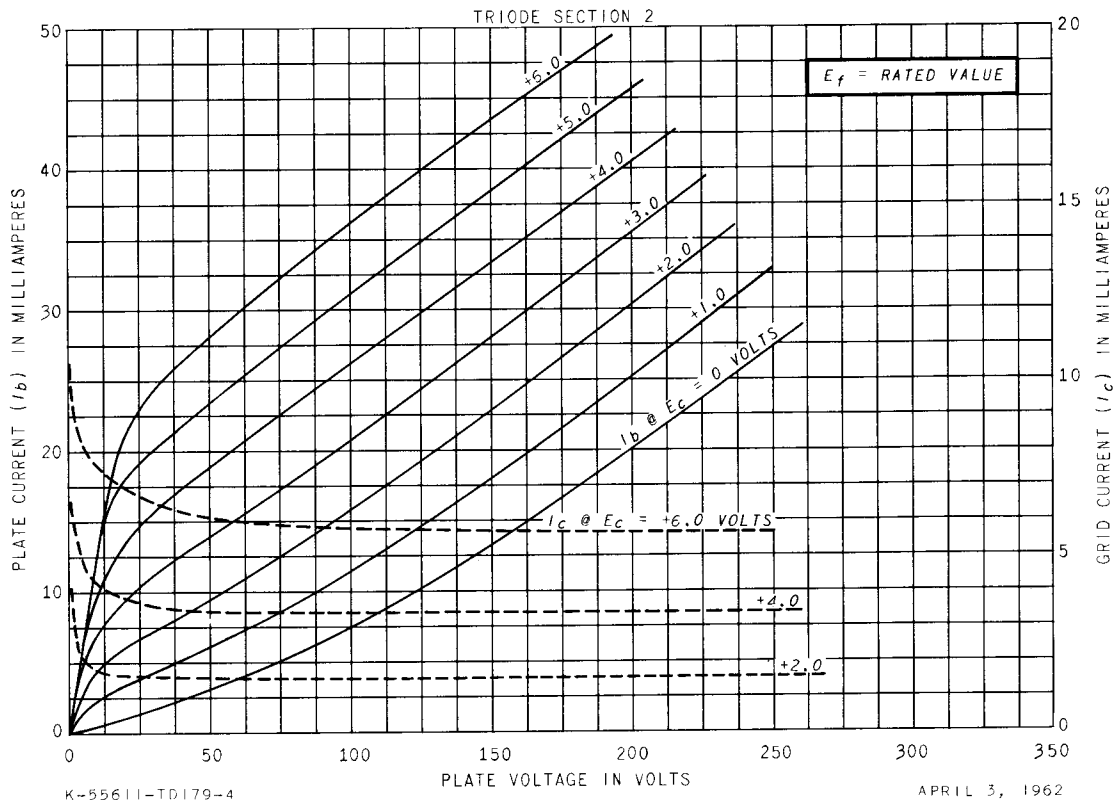

AVERAGE PLATE CHARACTERISTICS

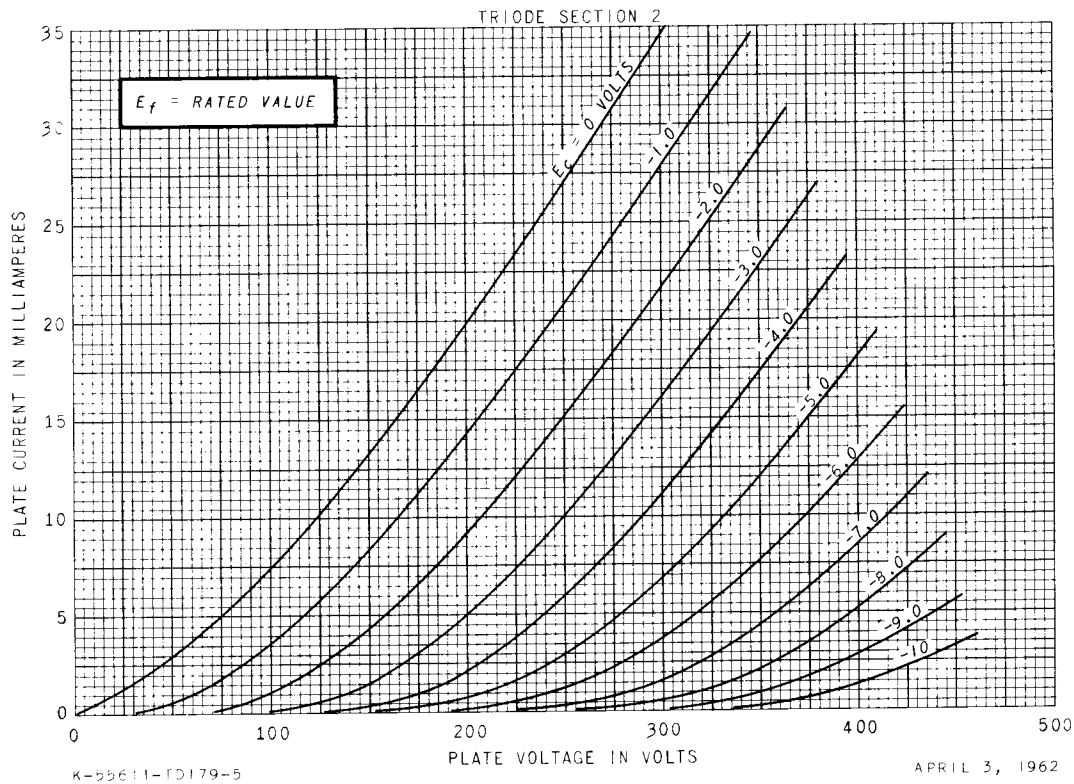

AVERAGE TRANSFER CHARACTERISTICS

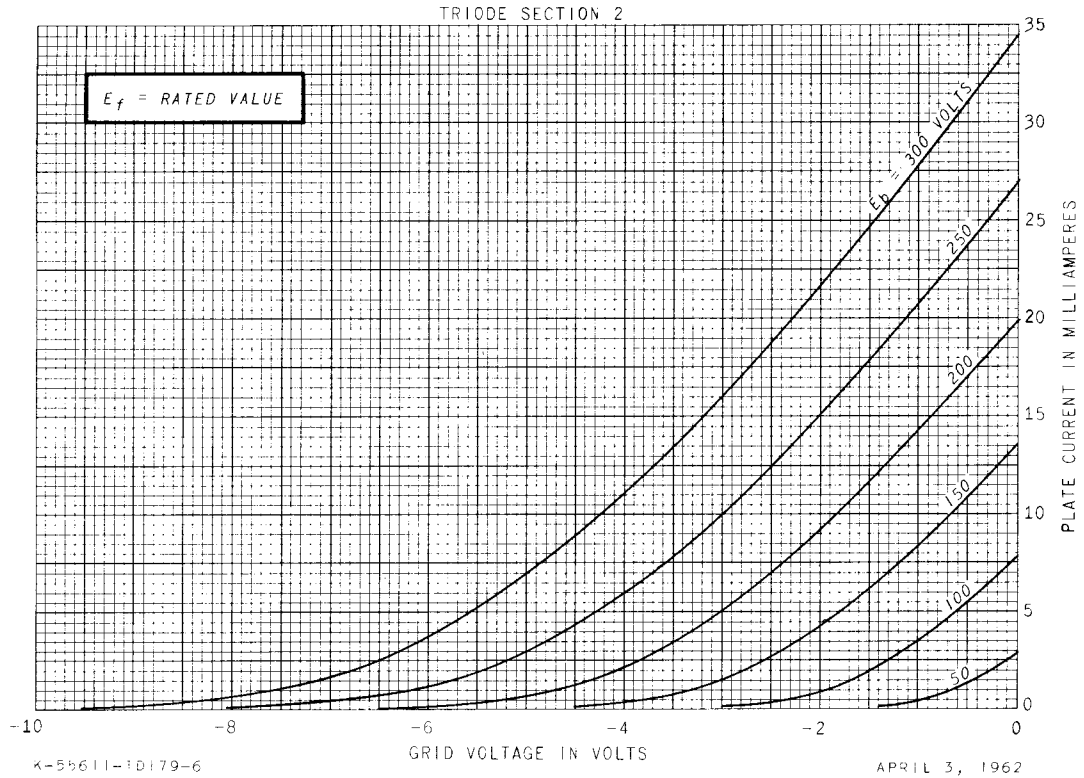

AVERAGE CHARACTERISTICS

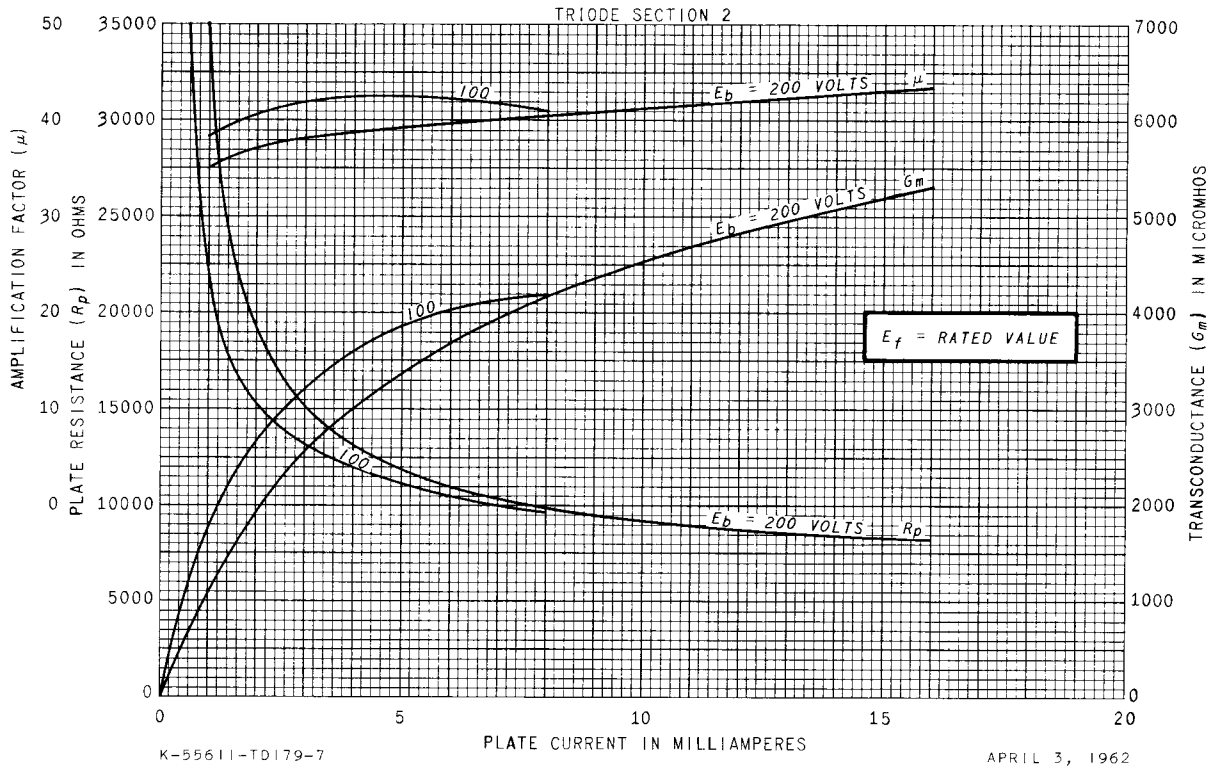

SCREEN RATING CHART

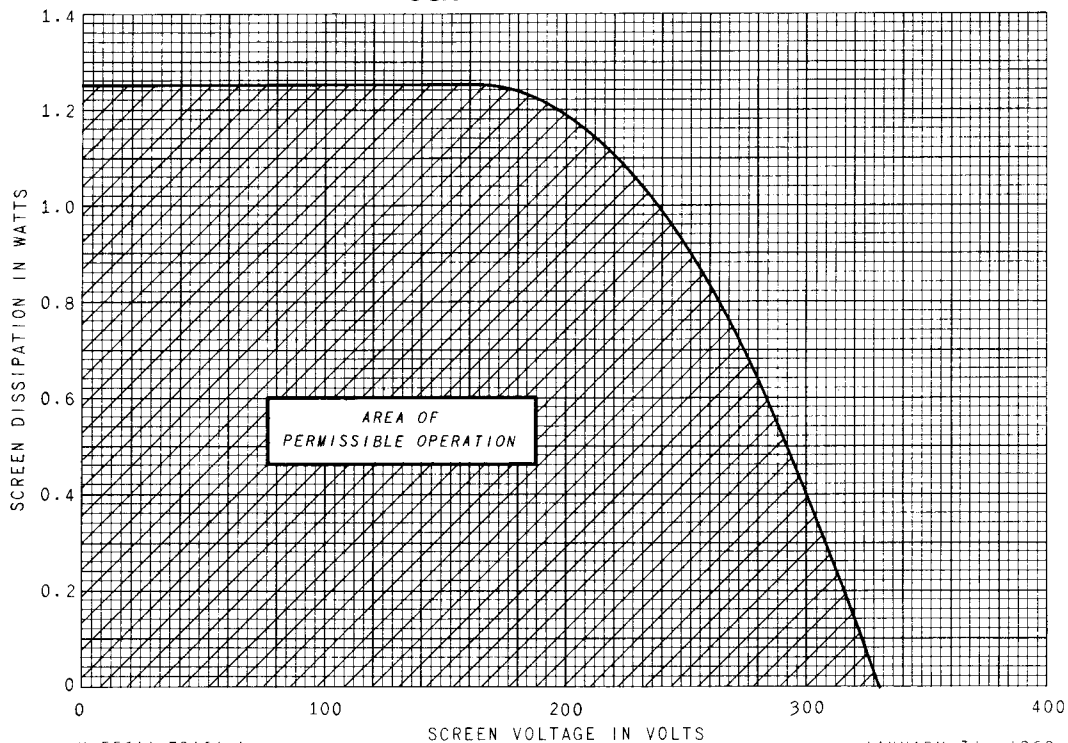

K-55611-TD164-1

JANUARY 31, 1962

AVERAGE PLATE CHARACTERISTICS

PENTODE SECTION

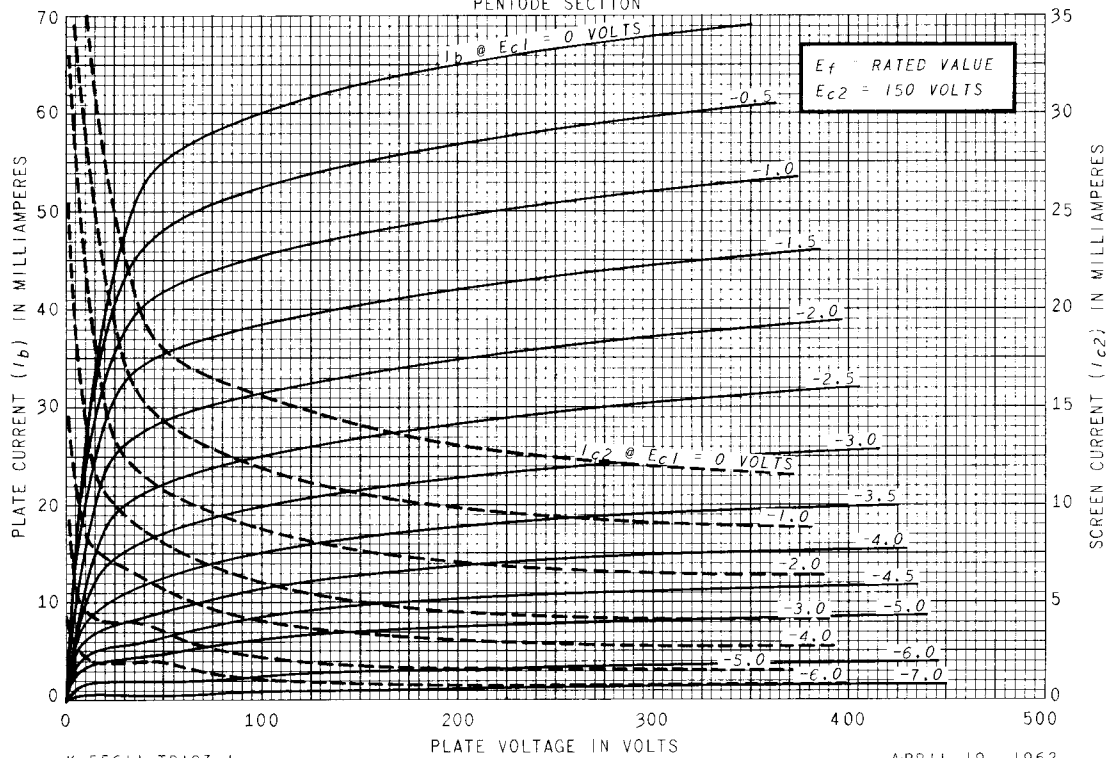

K-55611-TD183-1

APRIL 19, 1962

AVERAGE PLATE CHARACTERISTICS

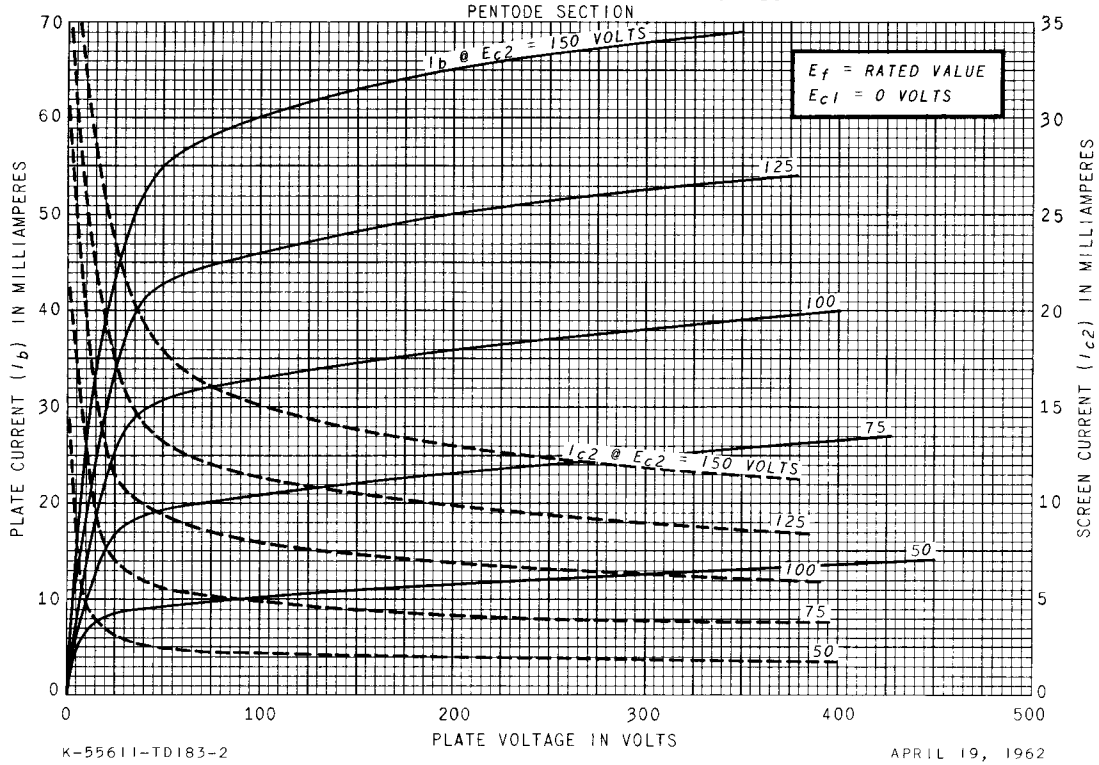

AVERAGE TRANSFER CHARACTERISTICS

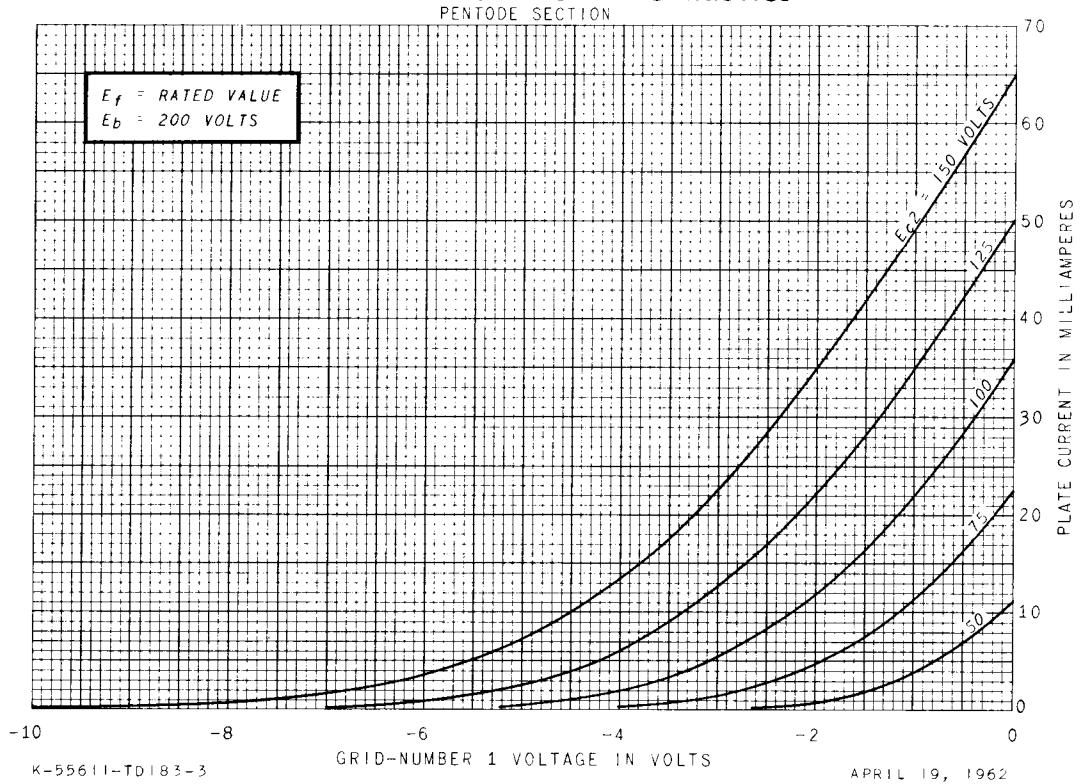

AVERAGE TRANSFER CHARACTERISTICS

PENTODE SECTION

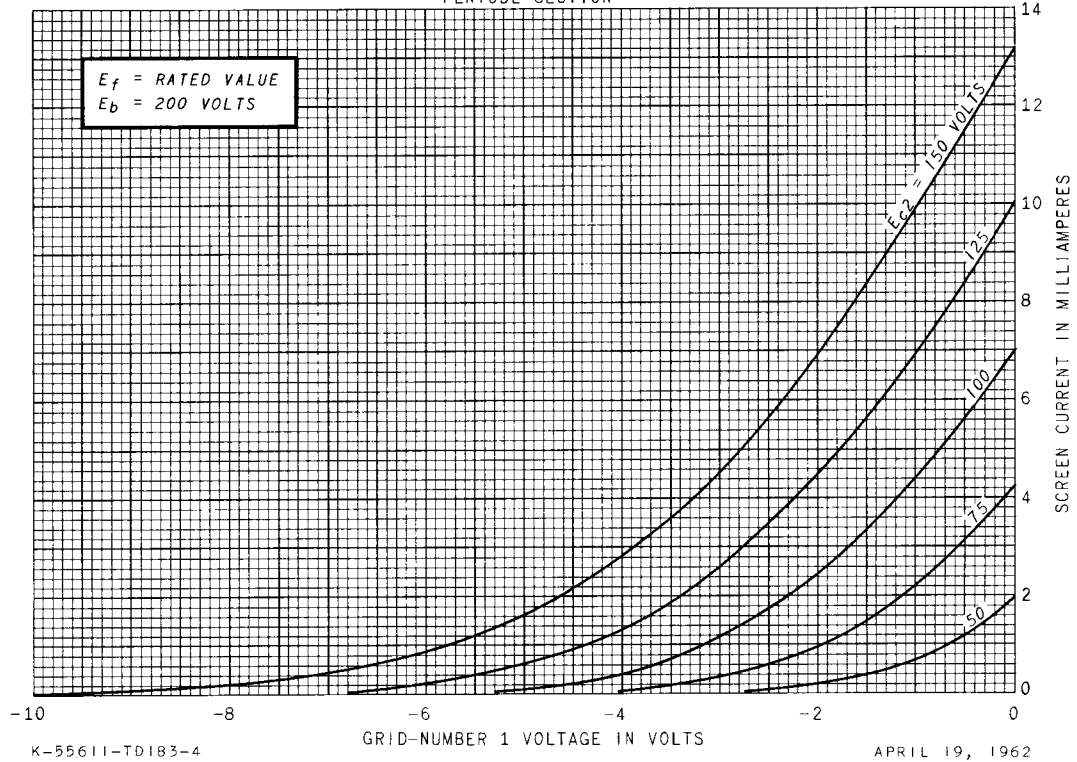

AVERAGE TRANSFER CHARACTERISTICS

PENTODE SECTION

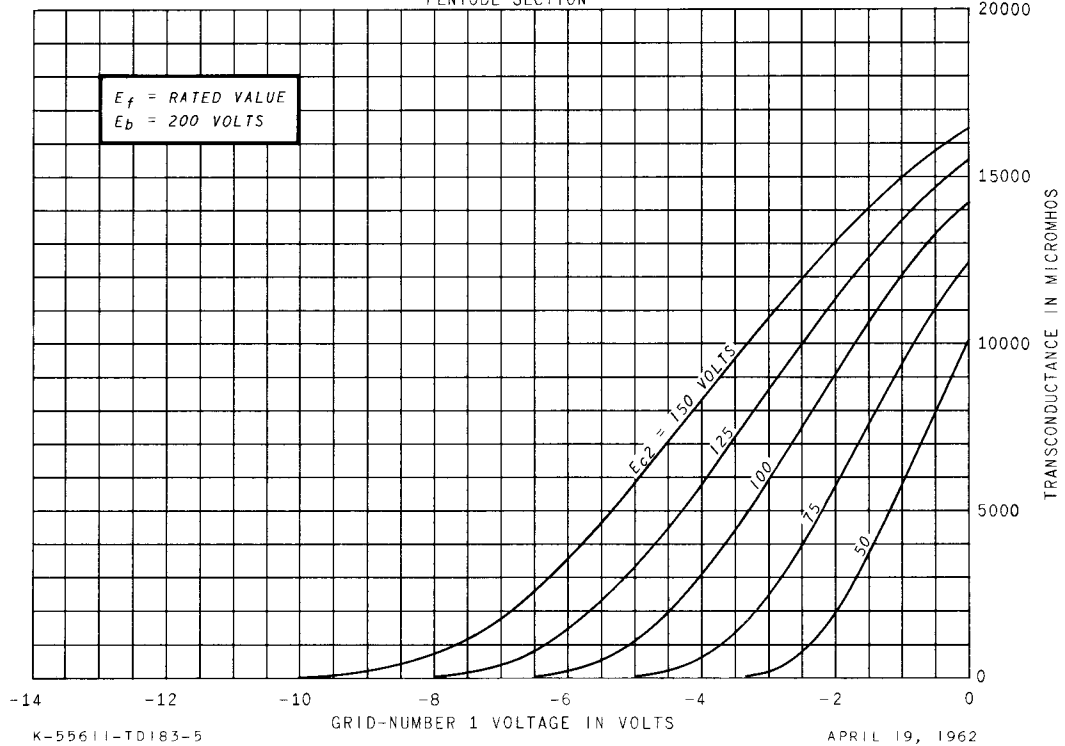

6AF11

Page 10
11-62

RECEIVING TUBE DEPARTMENT

GENERAL  **ELECTRIC**

Owensboro, Kentucky