

TRIODE-PENTODE

DESCRIPTION AND RATING

The 6AW8-A is a miniature tube containing a high-mu triode and a sharp-cutoff pentode. The triode section is intended for service as a sync separator and the pentode section as a video amplifier. As a result of its controlled heater-warm-up characteristic, the 6AW8-A is especially suited for use in television receivers which employ 600-milliamper, series-connected heaters. The 6AW8-A differs from the 6AW8 by incorporating a controlled plate-knee characteristic.

Except for heater ratings, the 8AW8-A is identical to the 6AW8-A. It is specially designed for use in television receivers which employ 450-milliamper, series-connected heaters.

GENERAL

ELECTRICAL

Cathode—Coated Unipotential

Heater Voltage	6.3	8.4	Volts
Heater Current	0.6	0.45	Amperes
Heater Warm-up Time*	11	11	Seconds

Direct Interelectrode Capacitances

	With Shield †	Without Shield	
Pentode Section			
Grid-Number 1 to Plate	0.03	0.04	μmf
Input	10	10	μmf
Output	4.5	3.6	μmf
Triode Section			
Grid to Plate	2.2	2.2	μmf
Input	3.4	3.2	μmf
Output	1.7	0.32	μmf
Pentode Grid-Number 1 to Triode Plate	0.003	0.006	μmf
Triode Grid to Pentode Plate	0.006	0.016	μmf
Pentode Plate to Triode Plate	0.023	0.150	μmf

MECHANICAL

Mounting Position—Any
Envelope—T-6½, Glass
Base—E9-1, Small Button 9-Pin

MAXIMUM RATINGS

DESIGN-CENTER VALUES	Pentode Section	Triode Section	
Plate Voltage	300	300	Volts
Screen-Supply Voltage	300	Volts
Screen Voltage—See Screen Rating Chart			
Positive DC Grid-Number 1 Voltage	0	0	Volts
Negative DC Grid-Number 1 Voltage	50	Volts
Plate Dissipation	3.25	1.0	Watts
Screen Dissipation	1.0	Watts
Heater-Cathode Voltage			
Heater Positive with Respect to Cathode			
DC Component	100	100	Volts
Total DC and Peak	200	200	Volts
Heater Negative with Respect to Cathode			
Total DC and Peak	200	200	Volts
Grid-Number 1 Circuit Resistance			
With Fixed Bias	0.25	0.5	Megohms
With Cathode Bias	1.0	1.0	Megohms

BASING DIAGRAM

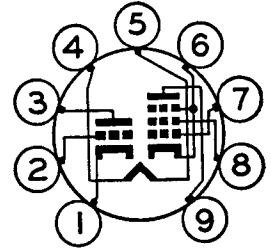

EIA 9DX

TERMINAL CONNECTIONS

- Pin 1—Triode Cathode
- Pin 2—Triode Grid
- Pin 3—Triode Plate
- Pin 4—Heater
- Pin 5—Heater
- Pin 6—Pentode Cathode, Grid Number 3, and Internal Shield
- Pin 7—Pentode Grid Number 1
- Pin 8—Pentode Grid Number 2 (Screen)
- Pin 9—Pentode Plate

PHYSICAL DIMENSIONS

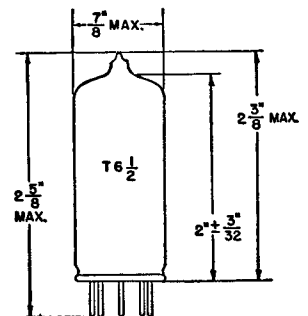

EIA 6-3



TRIODE-PENTODE DESCRIPTION AND RATING

The 6AW8-A is a miniature tube containing a high-mu triode and a sharp-cutoff pentode. The triode section is intended for service as a sync separator and the pentode section as a video amplifier. As a result of its controlled heater-warm-up characteristic, the 6AW8-A is especially suited for use in television receivers which employ 600-milliampere, series-connected heaters. The 6AW8-A differs from the 6AW8 by incorporating a controlled plate-knee characteristic.

GENERAL

ELECTRICAL

Cathode—Coated Unipotential	Series	Parallel
Heater Characteristics and Ratings	Heater	Heater
Heater Voltage, AC or DC	Operation	Operation
Heater Current	6.3* 6.3 ± 0.6 † Volts	
Heater Warm-up Time ††	0.6 ± 0.04 †	0.6 § Amperes
	11 Seconds	
Direct Interelectrode Capacitances	With Shield #	Without Shield
Pentode Section		
Grid-Number 1 to Plate:		
(Pg1 to Tp), maximum	0.04	0.05 pf
Input:		
Pg 1 to (h + Pk + Pg2 + Pg3 + i.s.)	10	10 pf
Output:		
Pp to (h + Pk + Pg2 + Pg3 + i.s.)	4.5	3.6 pf

ELECTRICAL (Cont'd)

Triode Section		
Grid to Plate: (Tg to Tp)	2.2	2.2 pf
Input: Tg to (h + Tk)	3.4	3.2 pf
Output: Tp to (h + Tk)	3.0	1.8 pf
Pentode Grid-Number 1 to Triode		
Plate: (Pg1 to Tp), maximum	0.005	0.008 pf
Pentode Plate to Triode Plate:		
(Pp to Tp), maximum	0.025	0.150 pf

MECHANICAL

Mounting Position—Any
Envelope—T-6½, Glass
Base—E9-1, Small Button 9-Pin

MAXIMUM RATINGS

DESIGN-MAXIMUM VALUES

	Pentode Section	Triode Section	
Plate Voltage	330	330	Volts
Screen-Supply Voltage	330	...	Volts
Screen Voltage—See Screen Rating Chart			
Positive DC Grid-Number 1 Voltage	0	0	Volts
Plate Dissipation	3.75	1.1	Watts
Screen Dissipation	1.1	...	Watts
Heater-Cathode Voltage			

	Pentode Section	Triode Section	
Heater Positive with Respect to Cathode			
DC Component	100	100	Volts
Total DC and Peak	200	200	Volts
Heater Negative with Respect to Cathode			
Total DC and Peak	200	200	Volts
Grid-Number 1 Circuit Resistance			
With Fixed Bias	0.25	0.5	Megohms
With Cathode Bias	1.0	1.0	Megohms

Design-Maximum ratings are limiting values of operating and environmental conditions applicable to a bogey electron tube of a specified type as defined by its published data and should not be exceeded under the worst probable conditions.

The tube manufacturer chooses these values to provide acceptable serviceability of the tube, making allowance for the effects of changes in operating conditions due to variations in the characteristics of the tube under consideration.

The equipment manufacturer should design so that initially and throughout life no design-maximum value for the intended service is exceeded with a bogey tube under the worst probable operating conditions with respect to supply-voltage variation, equipment component variation, equipment control adjustment, load variation, signal variation, environmental conditions, and variations in the characteristics of all other electron devices in the equipment.

PHYSICAL DIMENSIONS

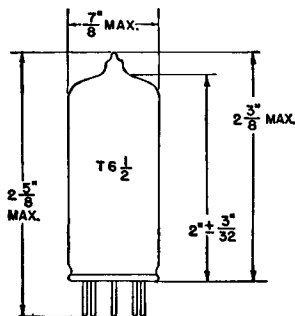

EIA 6-3

TERMINAL CONNECTIONS

- Pin 1—Triode Cathode
- Pin 2—Triode Grid
- Pin 3—Triode Plate
- Pin 4—Heater
- Pin 5—Heater
- Pin 6—Pentode Cathode, Grid Number 3, and Internal Shield
- Pin 7—Pentode Grid Number 1
- Pin 8—Pentode Grid Number 2 (Screen)
- Pin 9—Pentode Plate

BASING DIAGRAM

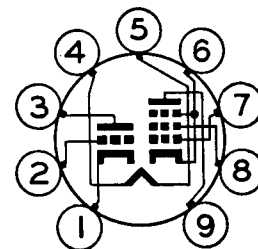

EIA 9DX

CHARACTERISTICS AND TYPICAL OPERATION

CLASS A₁ AMPLIFIER

	Pentode Section		Triode Section	
Plate Voltage	65	200	200	Volts
Screen Voltage	150	150	Volts
Grid-Number 1 Voltage	0 \ddagger	-2.0	Volts
Cathode-Bias Resistor	180	Ohms
Amplification Factor	70	
Plate Resistance, approximate	400000	17500	Ohms
Transconductance	9000	4000	Micromhos
Plate Current	42	13	4.0	Milliamperes
Screen Current	12.5	3.5	Milliamperes
Grid-Number 1 Voltage, approximate I _b = 10 Microamperes	-10	-5	Volts

* The time required for the voltage across the heater to reach 80 percent of its rated value after applying 4 times rated heater voltage to a circuit consisting of the tube heater in series with a resistance equal to 3 times the rated heater voltage divided by the rated heater current.

† With external shield (EIA 315) connected to cathode of section under test.

‡ Applied for short interval (two seconds maximum) so as not to damage tube.

AVERAGE PLATE CHARACTERISTICS

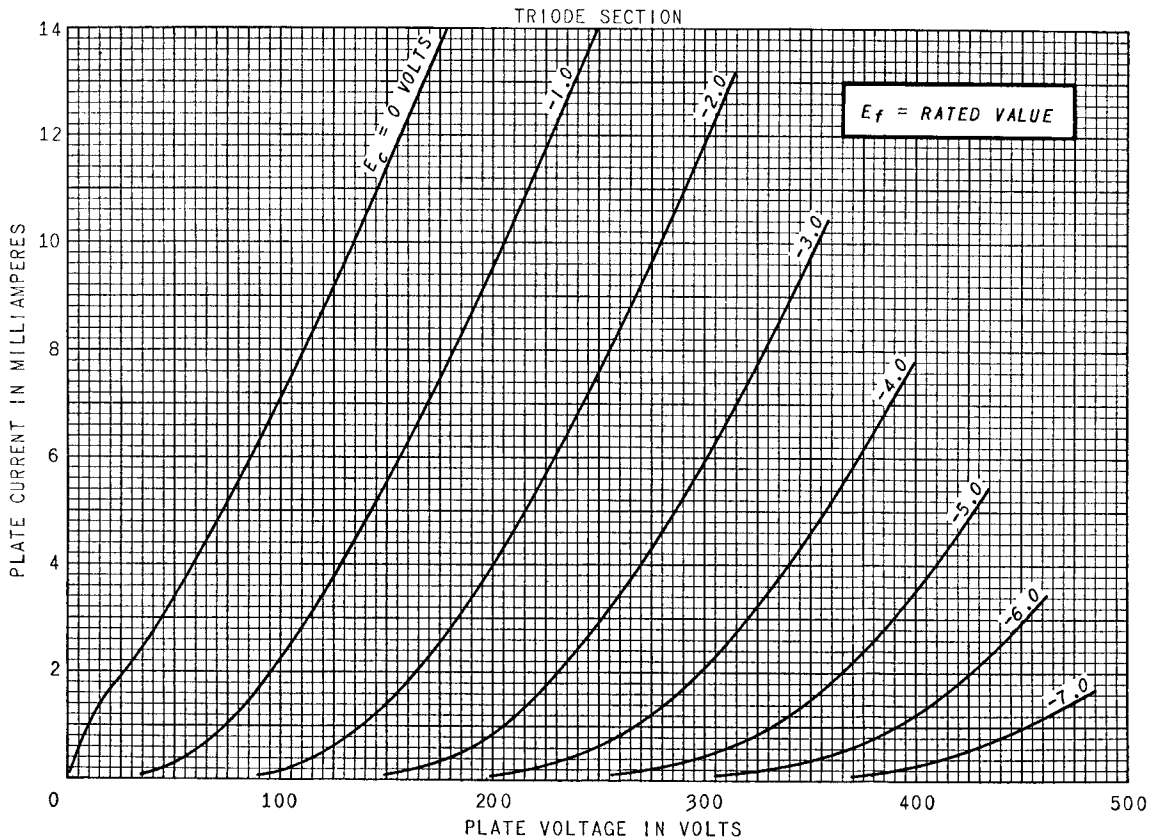

CHARACTERISTICS AND TYPICAL OPERATION

CLASS A₁ AMPLIFIER

	Pentode Section	Triode Section
Plate Voltage.....	150	200 Volts
Screen Voltage.....	150 Volts
Grid-Number 1 Voltage.....	0 Δ	-2.0 Volts
Cathode-Bias Resistor.....	150 Ohms
Amplification Factor.....	70
Plate Resistance, approximate.....	200000 Ohms
Transconductance.....	9500	4000 Micromhos
Plate Current.....	15	4.0 Milliamperes
Screen Current.....	3.5 Milliamperes
Grid-Number 1 Voltage, approximate I _b = 20 Microamperes.....	-8	-5 Volts

FOOTNOTES

- * Heater voltage for a bogey tube at I_f = 0.6 amperes.
- † For series heater operation, the equipment designer should design the equipment so that heater current is centered at the specified bogey value, with heater supply variations restricted to maintain heater current within the specified tolerance.
- ‡ The equipment designer should design the equipment so that heater voltage is centered at the specified bogey value, with heater supply variations restricted to maintain heater voltage within the specified tolerance.
- § Heater current of a bogey tube at E_f = 6.3 volts.
- ¶ The time required for the voltage across the heater to reach 80 percent of its rated value after applying 4 times rated heater voltage to a circuit consisting of the tube heater in series with a resistance equal to 3 times the rated heater voltage divided by the rated heater current.
- # With external shield (EIA 315) connected to cathode of section under test.
- Δ Applied for short interval (two seconds maximum) so as not to damage tube.

The tubes and arrangements disclosed herein may be covered by patents of General Electric Company or others. Neither the disclosure of any information herein nor the sale of tubes by General Electric Company conveys any license under patent claims covering combinations of tubes with other devices or

elements. In the absence of an express written agreement to the contrary, General Electric Company assumes no liability for patent infringement arising out of any use of the tubes with other devices or elements by any purchaser of tubes or others.

AVERAGE PLATE CHARACTERISTICS

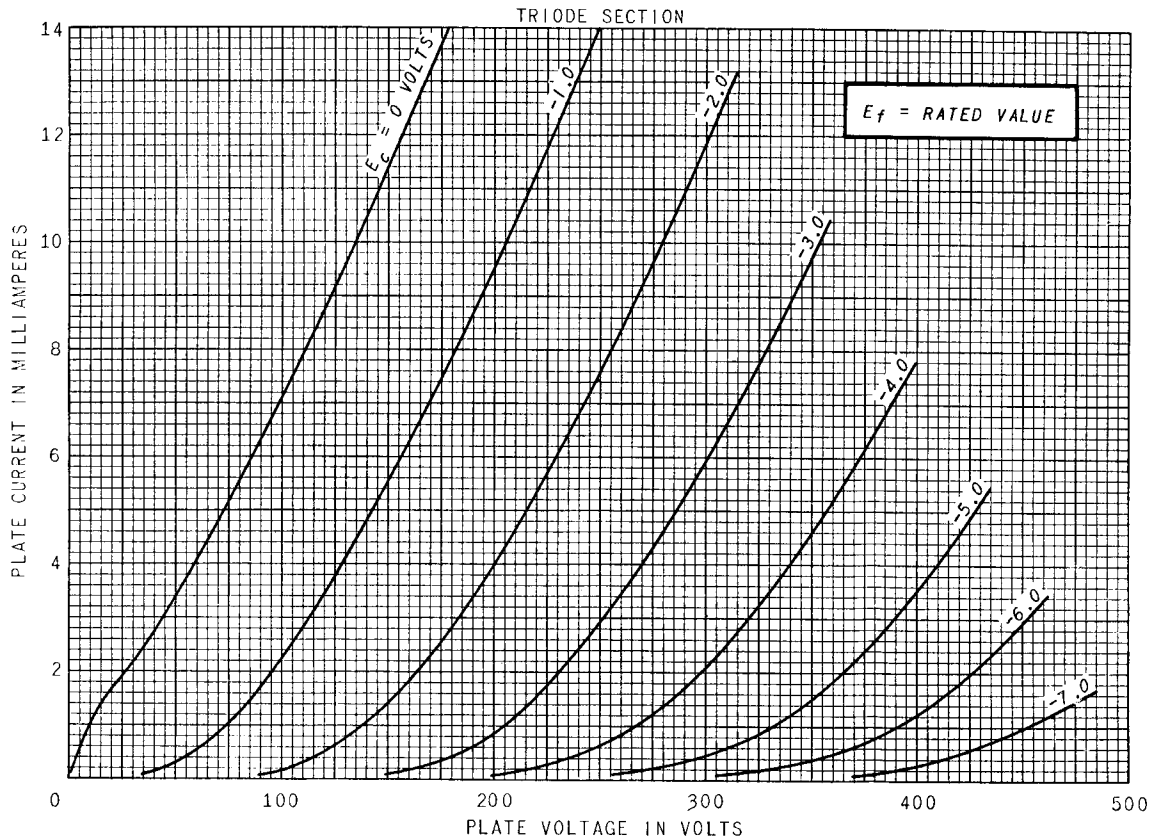

AVERAGE PLATE CHARACTERISTICS

TRIODE SECTION

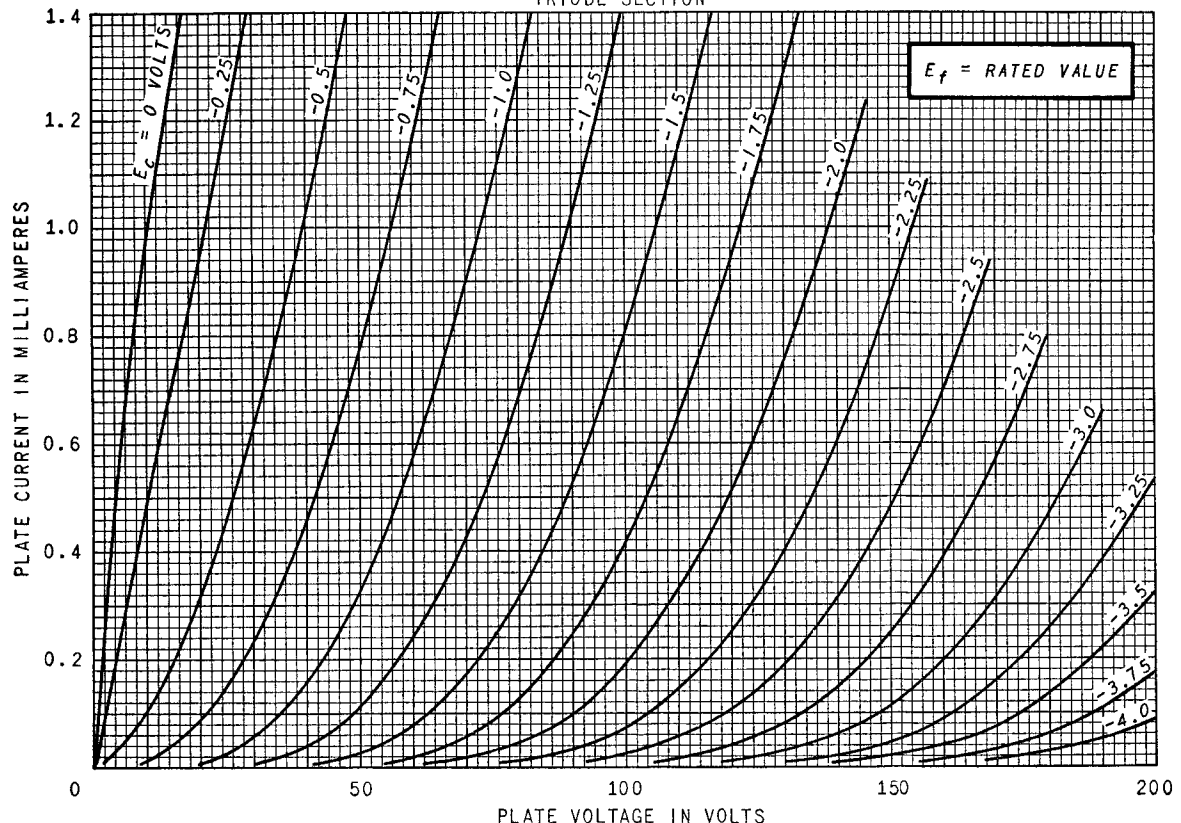

AVERAGE TRANSFER CHARACTERISTICS

TRIODE SECTION

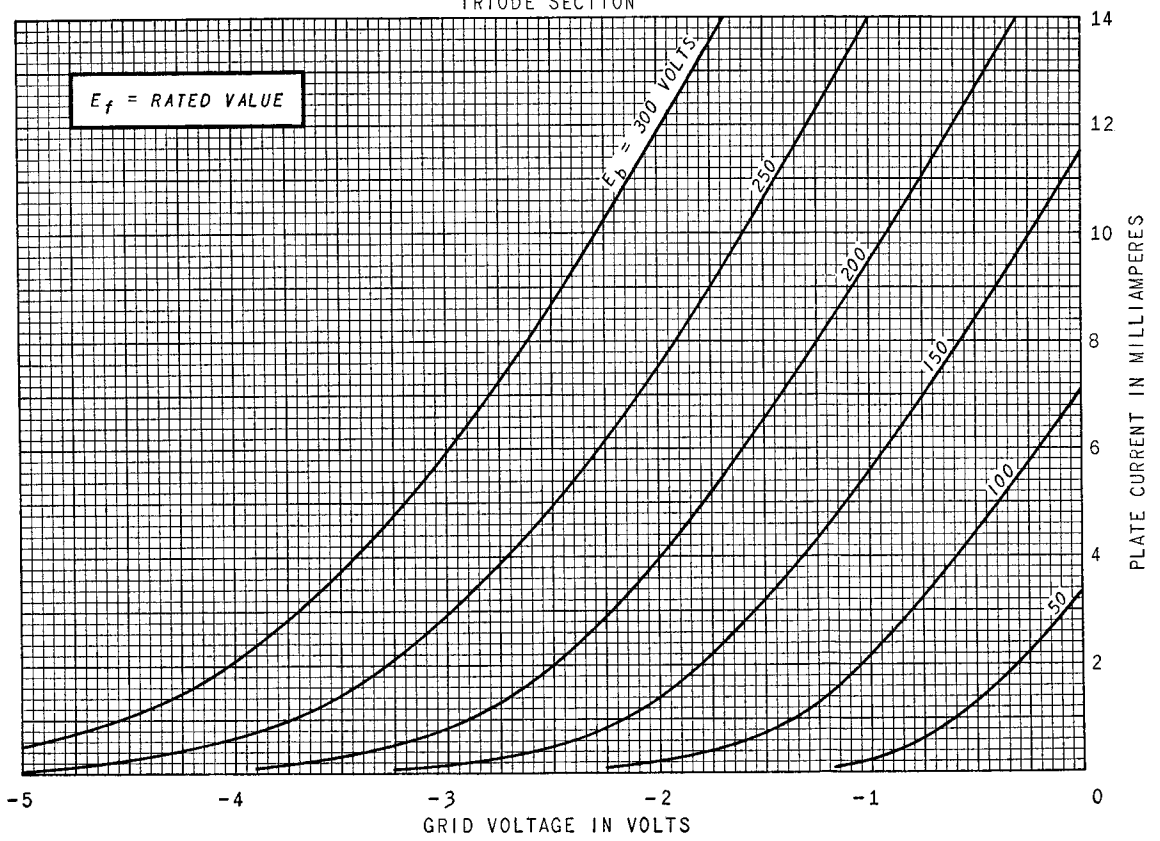

AVERAGE CHARACTERISTICS

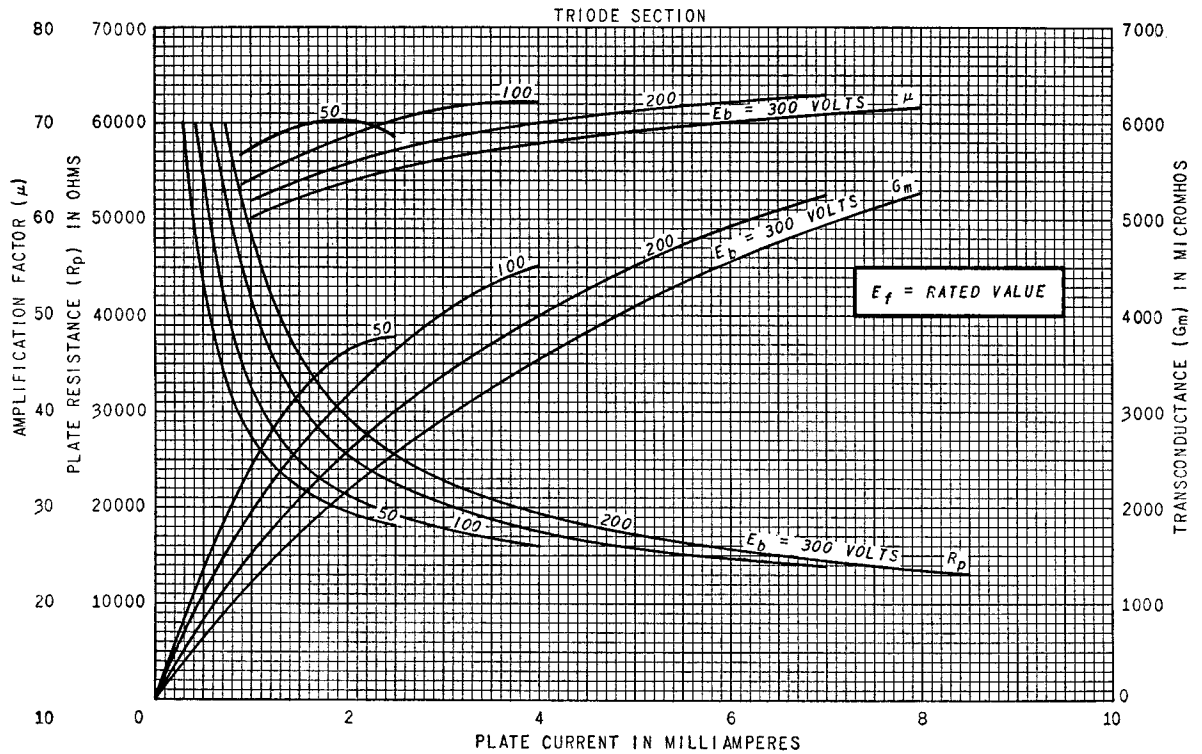

SCREEN RATING CHART

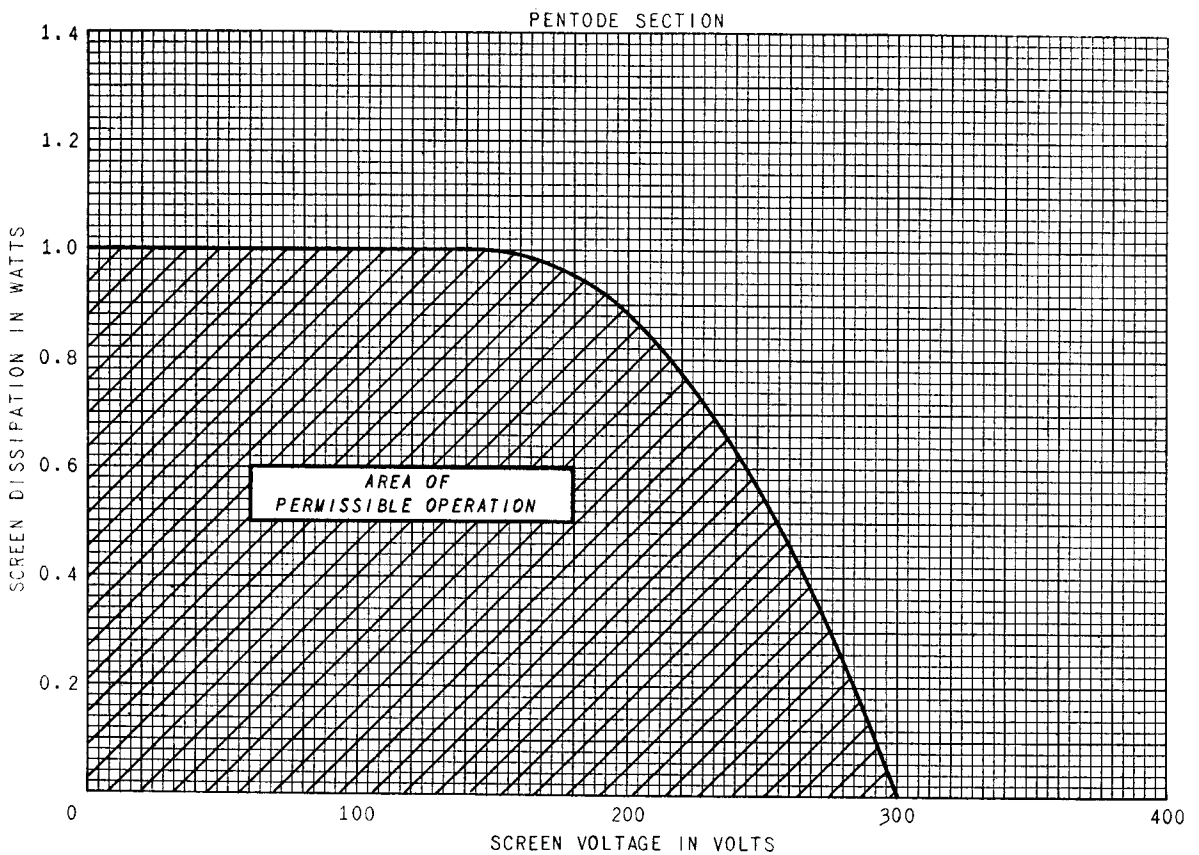

AVERAGE PLATE CHARACTERISTICS

PENTODE SECTION

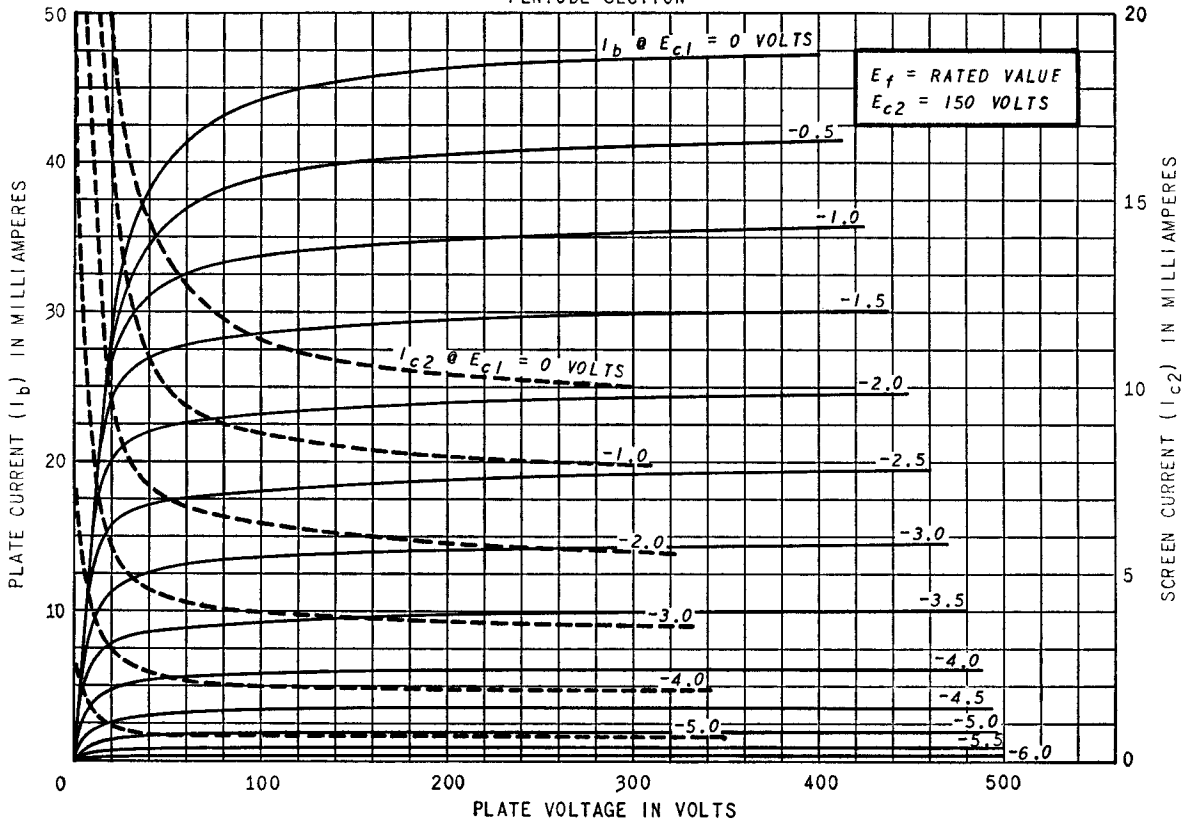

AVERAGE PLATE CHARACTERISTICS

PENTODE SECTION

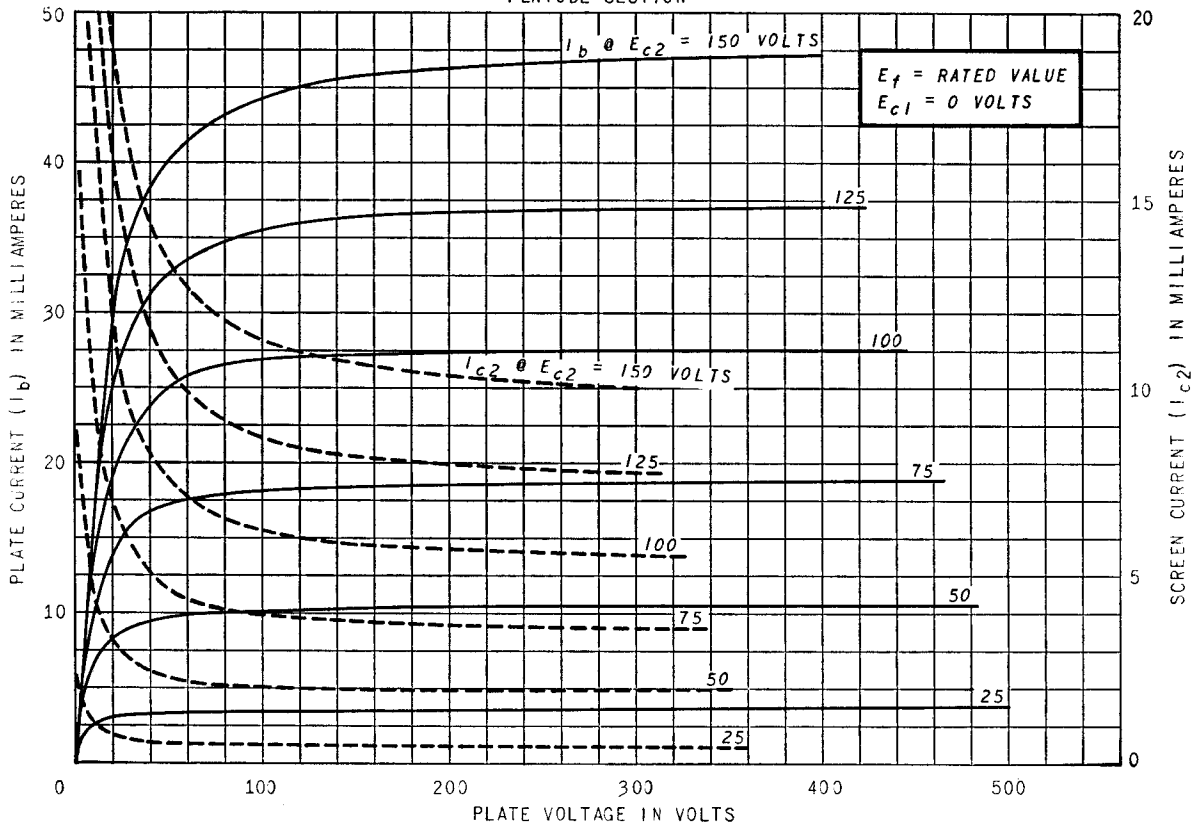

AVERAGE TRANSFER CHARACTERISTICS

PENTODE SECTION

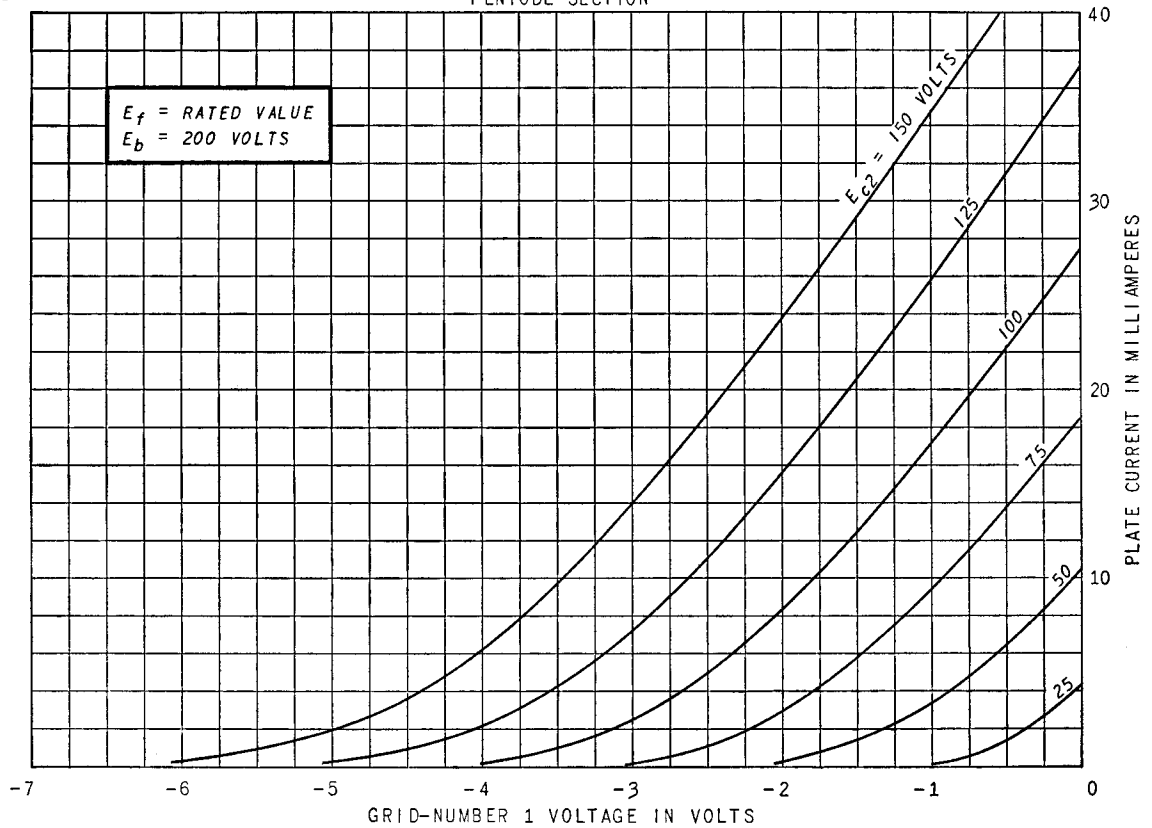

AVERAGE TRANSFER CHARACTERISTICS

PENTODE SECTION

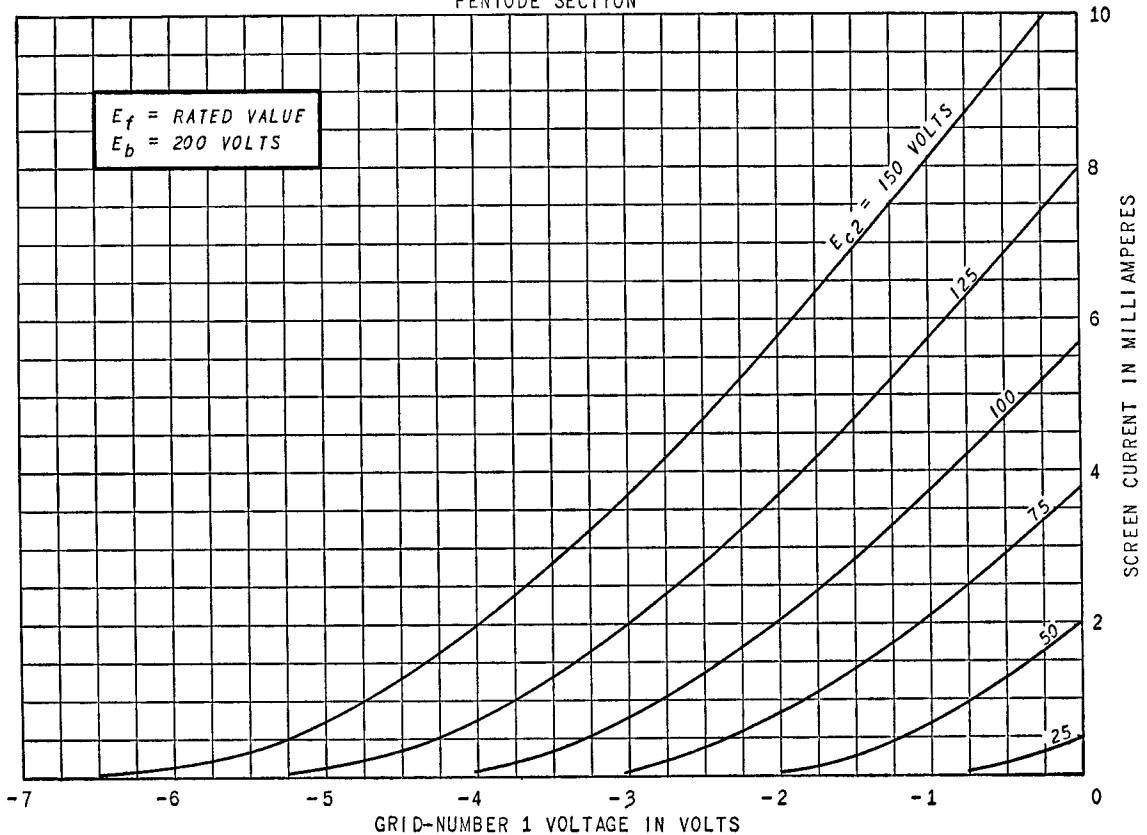

AVERAGE TRANSFER CHARACTERISTICS

PENTODE SECTION

