

**TUNG-SOL**

**PENTODE**

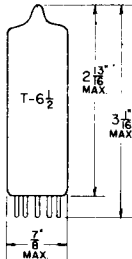

GLASS BULB  
E9-1 BASE

OUTLINE DRAWING  
JEDEC 6-4

COATED UNIPOTENTIAL CATHODE

HEATER

6.3 VOLTS 0.76 AMP.

AC OR DC

ANY MOUNTING POSITION

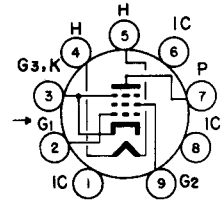

BOTTOM VIEW  
BASING DIAGRAM  
JEDEC 9CV

THE 6CW5 IS AN A.F. OUTPUT PENTODE IN THE 9 PIN MINIATURE CONSTRUCTION. IT IS INTENDED FOR USE IN SINGLE-ENDED PUSH-PULL OUTPUT STAGES.

**DIRECT INTERELECTRODE CAPACITANCES**

GRID #1 TO ALL OTHER ELEMENTS	12	$\mu\text{f}$
PLATE TO ALL OTHER ELEMENTS	6.0	$\mu\text{f}$
PLATE TO GRID #1 (MAX.)	0.6	$\mu\text{f}$
GRID #1 TO HEATER (MAX.)	0.25	$\mu\text{f}$

**RATINGS**

INTERPRETED ACCORDING TO DESIGN CENTER SYSTEM

HEATER VOLTAGE	6.3	VOLTS
MAXIMUM PLATE VOLTAGE	250	VOLTS
MAXIMUM PLATE VOLTAGE WITHOUT PLATE CURRENT	550	VOLTS
MAXIMUM PLATE DISSIPATION	12	WATTS
MAXIMUM GRID #2 VOLTAGE	200	VOLTS
MAXIMUM GRID #2 VOLTAGE WITHOUT CURRENT	550	VOLTS
MAXIMUM GRID #2 DISSIPATION	1.75	WATTS
MAXIMUM GRID #2 PEAK DISSIPATION	6	WATTS
MAXIMUM CATHODE CURRENT	100	MAMPS
MAXIMUM GRID #1 CIRCUIT RESISTANCE WITH AUTOMATIC BIAS	1	MEGOHM
MAXIMUM PEAK CATHODE TO HEATER VOLTAGE (CATHODE POSITIVE WITH RESPECT TO THE HEATER)	300	VOLTS
DC COMPONENT OF SAME	150	VOLTS
MAXIMUM CATHODE TO HEATER VOLTAGE (CATHODE NEGATIVE WITH RESPECT TO HEATER)	100	VOLTS
MAXIMUM CIRCUIT RESISTANCE BETWEEN HEATER AND CATHODE	20 000	OHMS

→ INDICATES A CHANGE.

CONTINUED ON FOLLOWING PAGE

## TUNG-SOL

CONTINUED FROM PRECEDING PAGE

## TYPICAL CHARACTERISTICS

HEATER VOLTAGE	6.3	VOLTS
HEATER CURRENT	0.76	AMP.
PLATE VOLTAGE	170	VOLTS
GRID #2 VOLTAGE	170	VOLTS
GRID #1 VOLTAGE	-12.5	VOLTS
PLATE CURRENT	70	MAMPS
GRID #2 CURRENT	5	MAMPS
TRANSCONDUCTANCE	10 000	$\mu$ MHOS
AMPLIFICATION FACTOR OF GRID #2 WITH RESPECT TO GRID #1	8	
PLATE RESISTANCE	23 000	OHMS

## OPERATING CHARACTERISTICS

CLASS A, ONE TUBE

HEATER VOLTAGE	6.3	VOLTS
HEATER CURRENT	0.76	AMP.
PLATE VOLTAGE	170	VOLTS
GRID #2 VOLTAGE	170	VOLTS
GRID #1 BIAS	-12.5	VOLTS
LOAD RESISTANCE	2400	OHMS
ZERO-SIGNAL PLATE CURRENT	70	MAMPS
ZERO-SIGNAL GRID #2 CURRENT	5	MAMPS
INPUT AF VOLTAGE (RMS)	7.0	VOLTS
MAX. SIGNAL PLATE CURRENT	70	MAMPS.
MAX. SIGNAL GRID #2 CURRENT	22	MAMPS
MAX. POWER OUTPUT	5.6	WATTS
TOTAL HARMONIC DISTORTION AT MAX. POWER OUTPUT	10	PERCENTS
INPUT AF VOLTAGE AT A POWER OUTPUT OF 50 MWATTS (RMS)	0.5	VOLTS

SINGLE-ENDED PUSH-PULL; TWO TUBES, SINGLE TONE<sup>A</sup>

HEATER VOLTAGE	6.3	VOLTS
HEATER CURRENT	0.76	AMP.
SUPPLY VOLTAGE	300	VOLTS
LOAD RESISTANCE	1000	OHMS
ZERO-SIGNAL CATHODE CURRENT	69	MAMPS
INPUT AF VOLTAGE (RMS)	5.7	VOLTS
MAX. SIGNAL CATHODE CURRENT	67	MAMPS
MAX. POWER OUTPUT	4.8	WATTS
TOTAL HARMONIC DISTORTION AT MAX. POWER OUTPUT	9.3	PERCENTS
INPUT AF VOLTAGE AT A POWER OUTPUT OF 50 MWATTS (RMS)	0.55	VOLTS

SINGLE-ENDED PUSH-PULL; TWO TUBES, DOUBLE TONE<sup>A</sup>

HEATER VOLTAGE	6.3	VOLTS
HEATER CURRENT	0.76	AMP.
SUPPLY VOLTAGE	300	VOLTS
LOAD RESISTANCE	1000	OHMS
ZERO-SIGNAL CATHODE CURRENT	69	MAMPS
INPUT AF VOLTAGE FOR EACH TONE SEPARATELY (RMS)	2.85	VOLTS
MAX. SIGNAL CATHODE CURRENT	67	MAMPS
MAX. POWER OUTPUT	5.9	WATTS
TOTAL HARMONIC DISTORTION AT MAX. POWER OUTPUT	8.5	PERCENTS

<sup>A</sup>SEE CIRCUIT DIAGRAM AND REMARK ON FOLLOWING PAGE

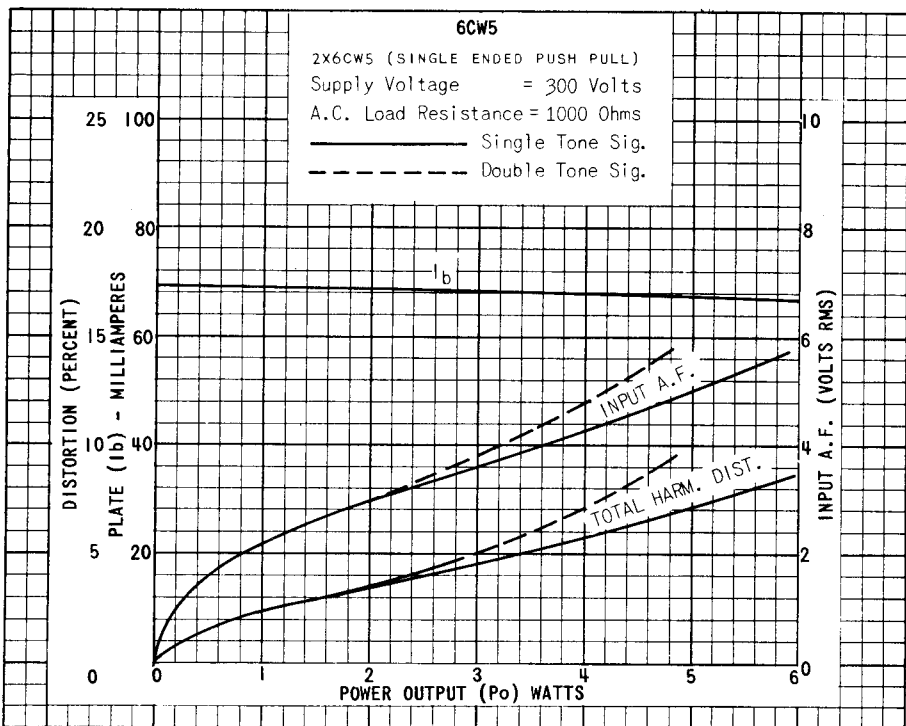
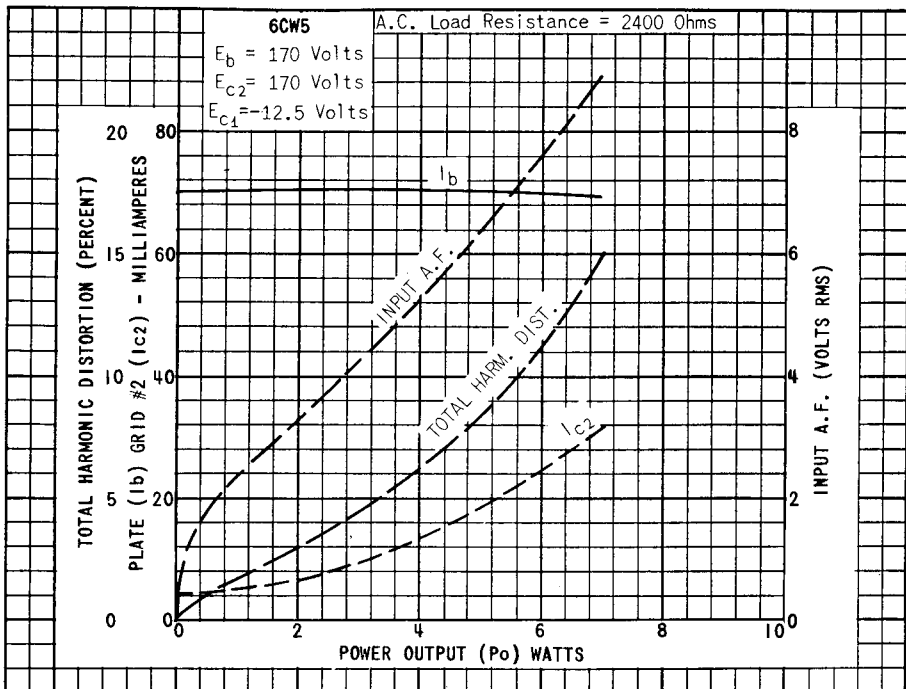

PRINTED IN U.S.A.

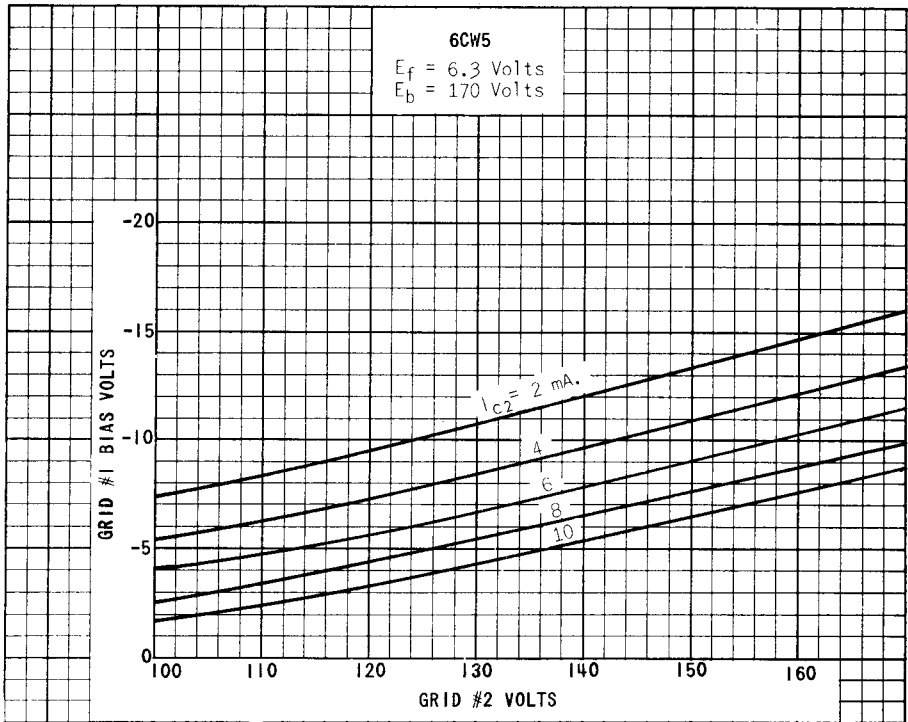
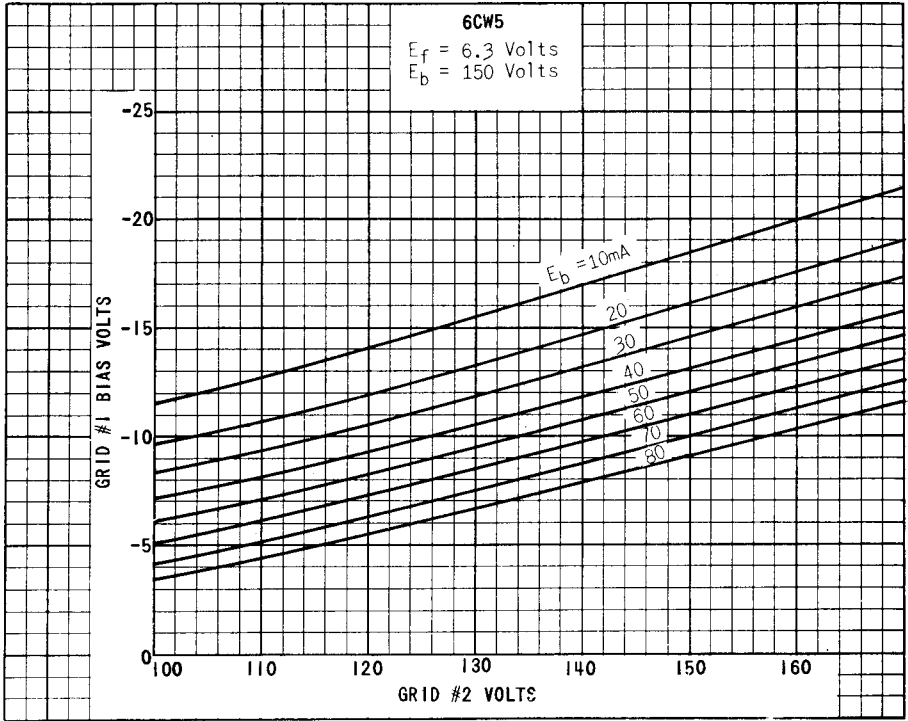

**TUNG-SOL**

CONTINUED FROM PRECEDING PAGE

**CIRCUIT DIAGRAM**  
OF  
**SINGLE-ENDED PUSH-PULL OUTPUT STAGE**

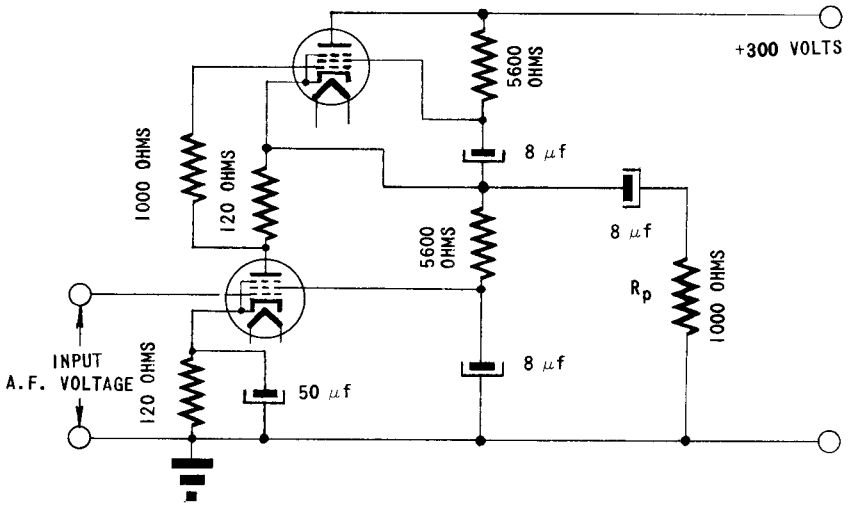

**REMARK**

SINGLE TONE DATA ARE OBTAINED WITH A PURE SINUSOIDAL INPUT VOLTAGE. HOWEVER, SUCH AN INPUT VOLTAGE IS IN GENERAL NOT REPRESENTATIVE FOR THE REPRODUCTION OF MUSIC AND SPEECH, SINCE A PURELY SINUSOIDAL TONE SELDOM OCCURS. THE DOUBLE TONE DATA ARE OBTAINED WITH TWO SINUSOIDAL SIGNALS OF DIFFERENT FREQUENCIES BUT OF THE SAME AMPLITUDE. THIS APPEARS TO BE FAR BETTER IN AGREEMENT WITH PRACTICE. IN THE CASE OF FULL DRIVE WITH TWO SINUSOIDAL SIGNALS DIFFERENT IN FREQUENCY BUT HAVING THE SAME AMPLITUDE THE OUTPUT POWER IS ABOUT HALF THE VALUE OBTAINED AT FULL DRIVE WITH A SINGLE SINUSOIDAL INPUT VOLTAGE OF TWICE THIS AMPLITUDE. TO MAKE COMPARISON POSSIBLE THE OBTAINED OUTPUT POWER WITH DOUBLE TONE IS THEREFORE MULTIPLIED BY 2.

PRINTED IN U.S.A.

