

$I_{F(AV)} = 7\text{Amp}$   
 $V_R = 30\text{V}$

**Major Ratings and Characteristics**

Characteristics	Values	Units
$I_{F(AV)}$ Rectangular waveform	7	A
$V_{RRM}$	30	V
$I_{FSM}$ @ tp = 5 $\mu$ s sine	535	A
$V_F$ @ 3Apk, $T_J = 125^\circ\text{C}$ (per leg)	0.35	V
$T_J$ range	-40 to 150	$^\circ\text{C}$

**Description/ Features**

The 6CWQ03FNPbF surface mount, center tap, Schottky rectifier series has been designed for applications requiring low forward drop and small foot prints on PC board. Typical applications are in disk drives, switching power supplies, converters, free-wheeling diodes, battery charging, and reverse battery protection.

- Popular D-PAK outline
- Center tap configuration
- Small foot print, surface mountable
- Low forward voltage drop
- High frequency operation
- Guard ring for enhanced ruggedness and long term reliability
- Lead-Free ("PbF" suffix)

**Case Styles**

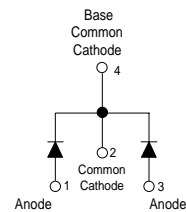

**D-PAK (TO-252AA)**

## 6CWQ03FNPbF

Bulletin PD-21056 rev. B 07/06

International  
IR Rectifier

### Voltage Ratings

Part number	6CWQ03FNPbF
$V_R$ Max. DC Reverse Voltage (V)	30
$V_{RWM}$ Max. Working Peak Reverse Voltage (V)	

### Absolute Maximum Ratings

Parameters	6CWQ...	Units	Conditions
$I_{F(AV)}$ Max. Average Forward (Per Leg) Current * See Fig. 5 (Per Device)	3.5	A	50% duty cycle @ $T_C = 134^\circ\text{C}$ , rectangular wave form
	7		
$I_{FSM}$ Max. Peak One Cycle Non-Repetitive Surge Current (Per Leg) * See Fig. 7	535	A	5 $\mu\text{s}$ Sine or 3 $\mu\text{s}$ Rect. pulse
	90		10ms Sine or 6ms Rect. pulse
$E_{AS}$ Non-Repet. Avalan. Energy (Per Leg)	8	mJ	$T_J = 25^\circ\text{C}$ , $I_{AS} = 2$ Amps, $L = 4$ mH
$I_{AR}$ Repetitive Avalanche Current (Per Leg)	1.0	A	Current decaying linearly to zero in 1 $\mu\text{sec}$ Frequency limited by $T_J$ max. $V_A = 1.5 \times V_R$ typical

### Electrical Specifications

Parameters	6CWQ...	Units	Conditions
$V_{FM}$ Max. Forward Voltage Drop (Per Leg) * See Fig. 1 (1)	0.45	V	@ 3A
	0.52	V	@ 6A
	0.35	V	@ 3A
	0.46	V	@ 6A
$I_{RM}$ Max. Reverse Leakage Current (Per Leg) * See Fig. 2 (1)	2	mA	$T_J = 25^\circ\text{C}$
	50	mA	$T_J = 125^\circ\text{C}$
$V_{F(TO)}$ Threshold Voltage	0.22	V	$T_J = T_J$ max.
$r_t$ Forward Slope Resistance	32.86	m $\Omega$	
$C_T$ Typ. Junction Capacitance (Per Leg)	290	pF	$V_R = 5V_{DC}$ (test signal range 100Khz to 1Mhz) $25^\circ\text{C}$
$L_S$ Typical Series Inductance (Per Leg)	5.0	nH	Measured lead to lead 5mm from package body
dv/dt Max. Voltage Rate of Change	10000	V/ $\mu\text{s}$	(Rated $V_R$ )

(1) Pulse Width < 300 $\mu\text{s}$ , Duty Cycle <2%

### Thermal-Mechanical Specifications

Parameters	6CWQ...	Units	Conditions
$T_J$ Max. Junction Temperature Range (*)	-40 to 150	$^\circ\text{C}$	
$T_{stg}$ Max. Storage Temperature Range	-40 to 150	$^\circ\text{C}$	
$R_{thJC}$ Max. Thermal Resistance (Per Leg) Junction to Case (Per Device)	4.70	$^\circ\text{C}/\text{W}$	DC operation * See Fig. 4
	2.35		
wt Approximate Weight	0.3(0.01)	g(oz.)	
Case Style	D-Pak		Similar to TO-252AA
Marking Device	6CWQ03FN		

(\*)  $\frac{dP_{tot}}{dT_J} < \frac{1}{R_{th(j-a)}}$  thermal runaway condition for a diode on its own heatsink

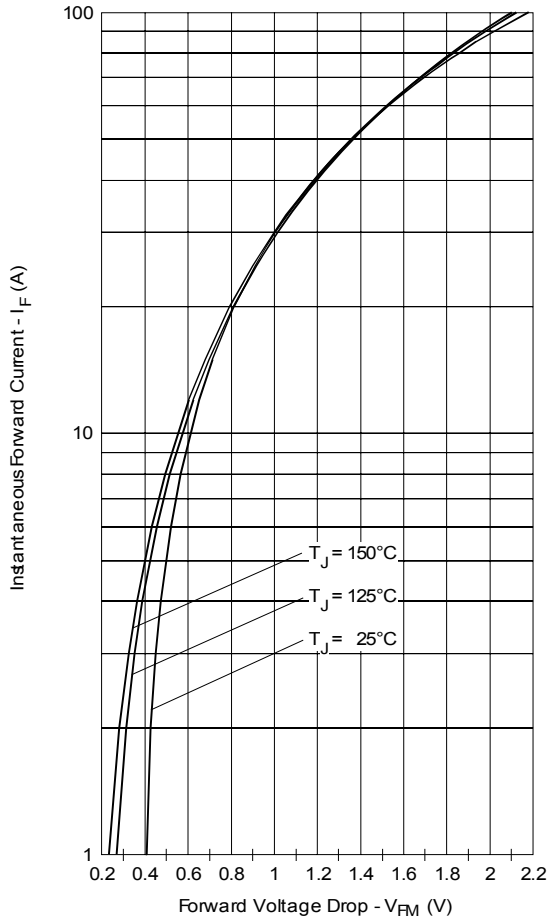

Fig. 1 - Max. Forward Voltage Drop Characteristics (Per Leg)

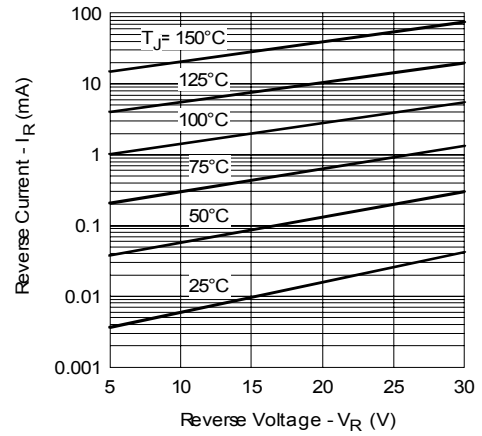

Fig. 2 - Typical Values Of Reverse Current Vs. Reverse Voltage (Per Leg)

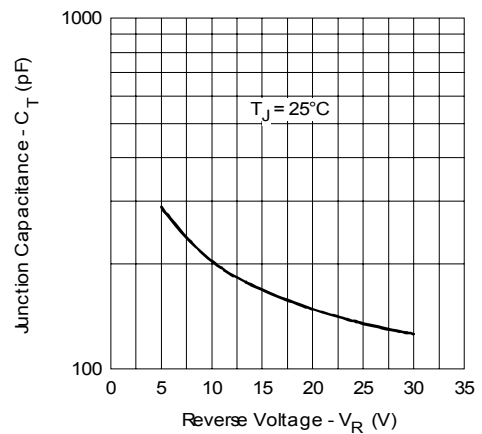

Fig. 3 - Typical Junction Capacitance Vs. Reverse Voltage (Per Leg)

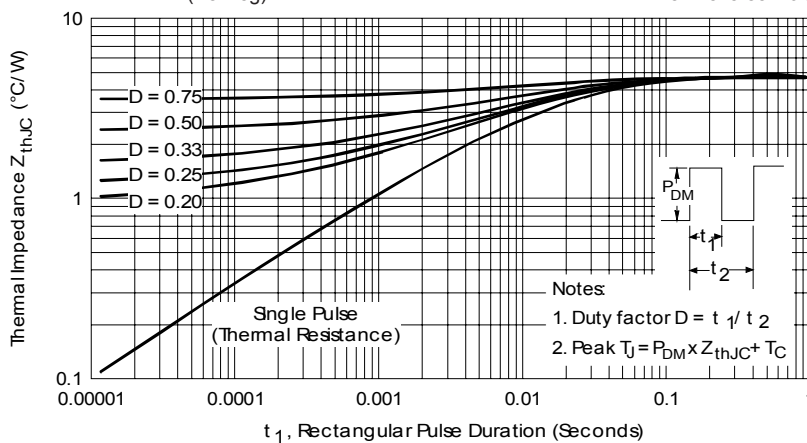

Fig. 4 - Max. Thermal Impedance  $Z_{thJC}$  Characteristics (Per Leg)

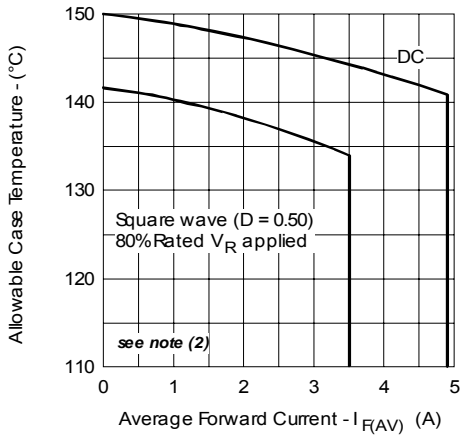

Fig. 5 - Max. Allowable Case Temperature Vs. Average Forward Current (Per Leg)

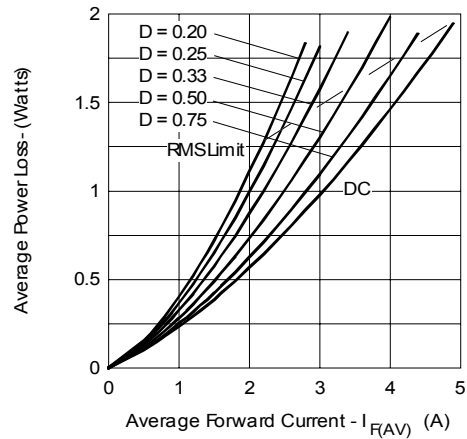

Fig. 6 - Forward Power Loss Characteristics (Per Leg)

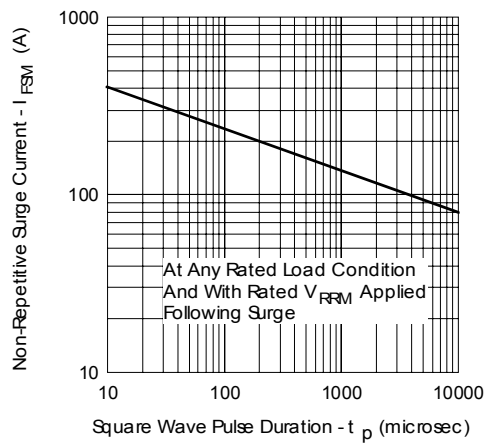

Fig. 7 - Max. Non-Repetitive Surge Current (Per Leg)

(2) Formula used:  $T_C = T_J - (Pd + Pd_{REV}) \times R_{thJC}$ ;  
 $Pd = \text{Forward Power Loss} = I_{F(AV)} \times V_{FM} @ (I_{F(AV)} / D)$  (see Fig. 6);  
 $Pd_{REV} = \text{Inverse Power Loss} = V_{R1} \times I_R (1 - D)$ ;  $I_R @ V_{R1} = 80\% \text{ rated } V_R$

Outline Table

NOTES

- 1.- DIMENSIONING AND TOLERANCING PER ASME Y14.5M-1994
- 2.- DIMENSIONS ARE SHOWN IN INCHES [MILLIMETERS]
- 3.- LEAD DIMENSION UNCONTROLLED IN L5
- 4.- DIMENSION D1, E1, L3 & S0 ESTABLISH A MINIMUM MOUNTING SURFACE FOR THERMAL PAD.
- 5.- SECTION C-C DIMENSIONS APPLY TO THE FLAT SECTION OF THE LEAD BETWEEN .025 AND 0.10 [0.15 AND 0.25] FROM THE LEAD TIP.
- 6.- DIMENSION D & E DO NOT INCLUDE MOLD FLASH. MOLD FLASH SHALL NOT EXCEED .005 [0.13] PER SIDE. THESE DIMENSIONS ARE MEASURED AT THE OUTMOST EXTREMES OF THE PLASTIC BODY.
- 7.- DIMENSION Δ1 & Δ1' APPLIED TO BASE METAL ONLY.
- 8.- DATUM A & B TO BE DETERMINED AT DATUM PLANE H.
- 9.- OUTLINE CONFORMS TO JEDEC OUTLINE TO-252AA.

SYMBOL	DIMENSIONS				NOMINAL VALUE
	MILLIMETERS		INCHES		
A	2.18	2.39	.086	.094	
A1	-	0.15	-	.005	
B	0.64	0.89	.025	.035	
B1	0.65	0.79	.025	.031	7
B2	0.76	1.14	.030	.045	
B3	4.90	0.46	.190	.215	4
C	0.46	0.61	.018	.024	
C1	0.41	0.56	.016	.022	7
C2	0.46	0.69	.018	.025	
D	5.97	6.22	.235	.245	6
D1	0.21	-	.008	-	4
E	6.35	6.73	.250	.265	6
E1	4.32	-	.170	-	4
H	2.29	BSC	.090	BSC	
H1	8.40	10.41	.370	.410	
L1	1.40	1.78	.055	.070	
L2	2.74	BSC	108	REF.	
L3	0.51	BSC	.020	BSC	
L4	0.80	1.27	.031	.050	4
L5	-	1.02	-	.040	
L6	1.14	1.52	.045	.060	3
φ	07	107	07	107	
φ1	07	157	07	157	
φ2	257	357	257	357	

LEAD ASSIGNMENTS

HEXFEET

- 1.- DATE
- 2.- DRAIN
- 3.- SOURCE
- 4.- DRAIN

ISBT & CoPAK

- 1.- DATE
- 2.- COLLECTOR
- 3.- EMITTER
- 4.- COLLECTOR

**Modified JEDEC outline TO-252AA**  
Dimensions in millimeters and (inches)

Part Marking Information

EXAMPLE: THIS IS A 6CWQ03FN  
LOT CODE 8024  
ASSEMBLED ON WW 02, 2000

INTERNATIONAL  
RECTIFIER  
LOGO

ASSEMBLY  
LOT CODE

PART NUMBER

DATE CODE  
P = LEAD-FREE  
YEAR 0 = 2000  
WEEK 02  
X = SITE ID

Tape & Reel Information

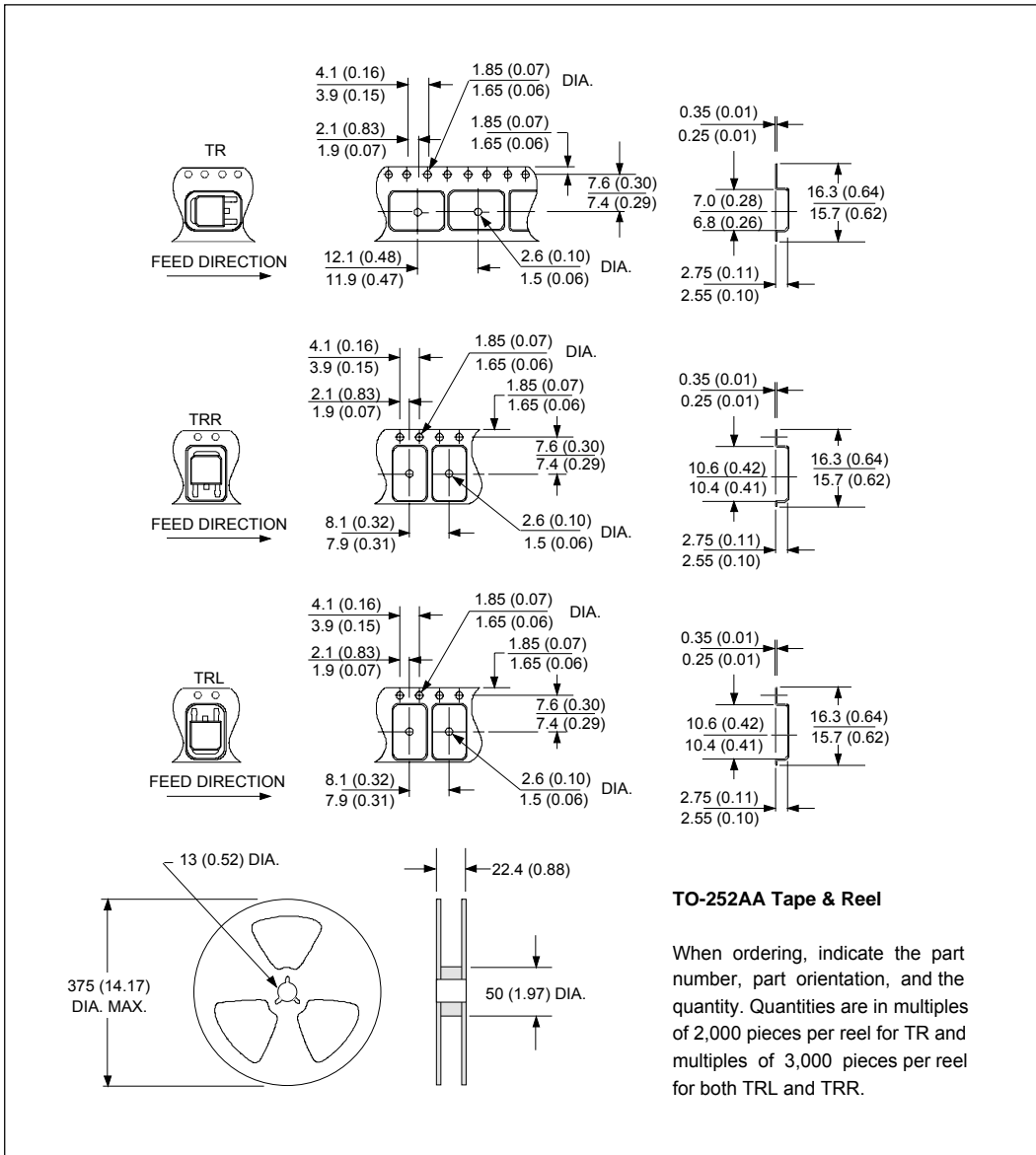

Ordering Information Table

Device Code	
<b>6</b>	<b>C</b>
<b>W</b>	<b>Q</b>
<b>03</b>	<b>FN</b>
<b>TRL</b>	<b>PbF</b>
①	②
③	④
⑤	⑥
⑦	⑧
<b>1</b>	- Current Rating (7A)
<b>2</b>	- Center Tap Configuration
<b>3</b>	- Package Identifier W = D-Pak
<b>4</b>	- Schottky "Q" Series
<b>5</b>	- Voltage Rating (03 = 30V)
<b>6</b>	- FN = TO-252AA (D-Pak)
<b>7</b>	- <ul style="list-style-type: none"> <li>• none = Tube (50 pieces)</li> <li>• TR = Tape &amp; Reel</li> <li>• TRL = Tape &amp; Reel (Left Oriented)</li> <li>• TRR = Tape &amp; Reel (Right Oriented)</li> </ul>
<b>8</b>	- <ul style="list-style-type: none"> <li>• none = Standard Production</li> <li>• PbF = Lead-Free</li> </ul>

Data and specifications subject to change without notice.  
 This product has been designed and qualified for AEC Q101 Level and Lead-Free.  
 Qualification Standards can be found on IR's Web site.