

## TRIODE-PENTODE FOR VHF CONVERTER APPLICATIONS

---

### DESCRIPTION AND RATING

---

The 6EA8 is a miniature tube which contains a sharp-cutoff pentode and a triode in one envelope. Each section has a separate cathode and is electrically independent. The tube is primarily intended for service as a combined triode oscillator and pentode mixer in television receivers. Incorporation of a controlled heater warm-up characteristic makes the tube especially suited for use in television receivers that employ series-connected heaters.

### GENERAL

#### ELECTRICAL

Cathode—Coated Unipotential

Heater Voltage, AC or DC . . . . .	6.3	Volts
Heater Current . . . . .	0.45 ± 6%	Amperes
Heater Warm-up Time* . . . . .	11	Seconds

Direct Interelectrode Capacitances

	With Shield†	Without Shield
<b>Pentode Section</b>		
Grid-Number 1 to Plate: (Pg1 to Pp) maximum . . . . .	0.01	0.02 μμf
Input: Pg1 to (h+Pk+Pg2+Pg3+i.s.) . . . . .	5.0	5.0 μμf
Output: Pp to (h+Pk+Pg2+Pg3+i.s.) . . . . .	3.4	2.6 μμf
Heater to Cathode: (Pk to h) . . . . .	3.0‡	3.0 μμf
<b>Triode Section</b>		
Grid to Plate (Tg to Tp) . . . . .	1.7	1.7 μμf
Input: Tg to (Tk+h+Pk+Pg3+i.s.) . . . . .	3.2	3.0 μμf
Output: Tp to (Tk+h+Pk+Pg3+i.s.) . . . . .	1.9	1.4 μμf
Heater to Cathode: (Tk to h) . . . . .	3.0‡	3.0 μμf

#### MECHANICAL

Mounting Position—Any  
Envelope—T-6½, Glass  
Base—E9-1, Small Button 9-Pin

#### BASING DIAGRAM

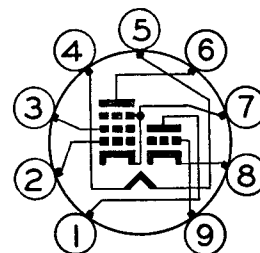

EIA 9AE

#### TERMINAL CONNECTIONS

- Pin 1—Triode Plate
- Pin 2—Pentode Grid Number 1
- Pin 3—Pentode Grid Number 2 (Screen)
- Pin 4—Heater
- Pin 5—Heater
- Pin 6—Pentode Plate
- Pin 7—Pentode Cathode, Grid Number 3 and Internal Shield
- Pin 8—Triode Cathode
- Pin 9—Triode Grid

#### PHYSICAL DIMENSIONS

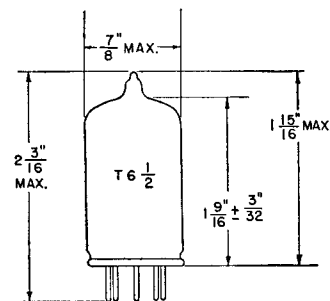

EIA 6-2

The tubes and arrangements disclosed herein may be covered by patents of General Electric Company or others. Neither the disclosure of any information herein nor the sale of tubes by General Electric Company conveys any license under patent claims covering combinations of tubes with other devices or elements. In the absence of an express written agreement to the contrary, General Electric Company assumes no liability for patent infringement arising out of any use of the tubes with other devices or elements by any purchaser of tubes or others.

## MAXIMUM RATINGS

### DESIGN-MAXIMUM VALUES

	Pentode Section	Triode Section
Plate Voltage . . . . .	.330	330 Volts
Screen Supply Voltage . . . . .	.330	. . . Volts
Screen Voltage—See Screen Rating Chart		
Positive DC Grid-Number 1 Voltage . . . . .	0	0 Volts
Plate Dissipation . . . . .	3.1	3.0 Watts
Screen Dissipation . . . . .	.055	. . . Watts
Heater-Cathode Voltage		
Heater Positive with Respect to Cathode		
DC Component . . . . .	100	100 Volts
Total DC and Peak . . . . .	200	200 Volts
Heater Negative with Respect to Cathode		
Total DC and Peak . . . . .	200	200 Volts

Design-Maximum ratings are limiting values of operating and environmental conditions applicable to a bogey tube of a specified type as defined by its published data, and should not be exceeded under the worst probable conditions.

The tube manufacturer chooses these values to provide acceptable serviceability of the tube, taking responsibility for the effects of changes in operating conditions due to variations in tube characteristics.

The equipment manufacturer should design so that initially and throughout life no design-maximum value for the intended service is exceeded with a bogey tube under the worst probable operating conditions with respect to supply-voltage variation, equipment component variation, equipment control adjustment, load variation, signal variation, and environmental conditions.

## CHARACTERISTICS AND TYPICAL OPERATION

### AVERAGE CHARACTERISTICS

	Pentode Section	Triode Section
Plate Voltage . . . . .	125	150 Volts
Screen Voltage . . . . .	125	. . . Volts
Grid-Number 1 Voltage . . . . .	-1.0	. . .
Cathode-Bias Resistor . . . . .	. . .	56 Ohms
Amplification Factor . . . . .	. . .	40
Plate Resistance, approximate . . . . .	80000	5000 Ohms
Transconductance . . . . .	6400	8500 Micromhos
Plate Current . . . . .	12	18 Milliamperes
Screen Current . . . . .	4.0	. . . Milliamperes
Grid-Number 1 Voltage, approximate		
<b>lb</b> = 10 Microamperes . . . . .	-9	-12 Volts

\* The time required for the voltage across the heater to reach 80 percent of its rated value after applying 4 times rated heater voltage to a circuit consisting of the tube heater in series with a resistance equal to 3 times the rated heater voltage divided by the rated heater current.

† With external shield (EIA 315) connected to cathode of section under test unless otherwise indicated.

‡ With external shield (EIA 315) connected to ground.

**SCREEN RATING CHART**

PENTODE SECTION

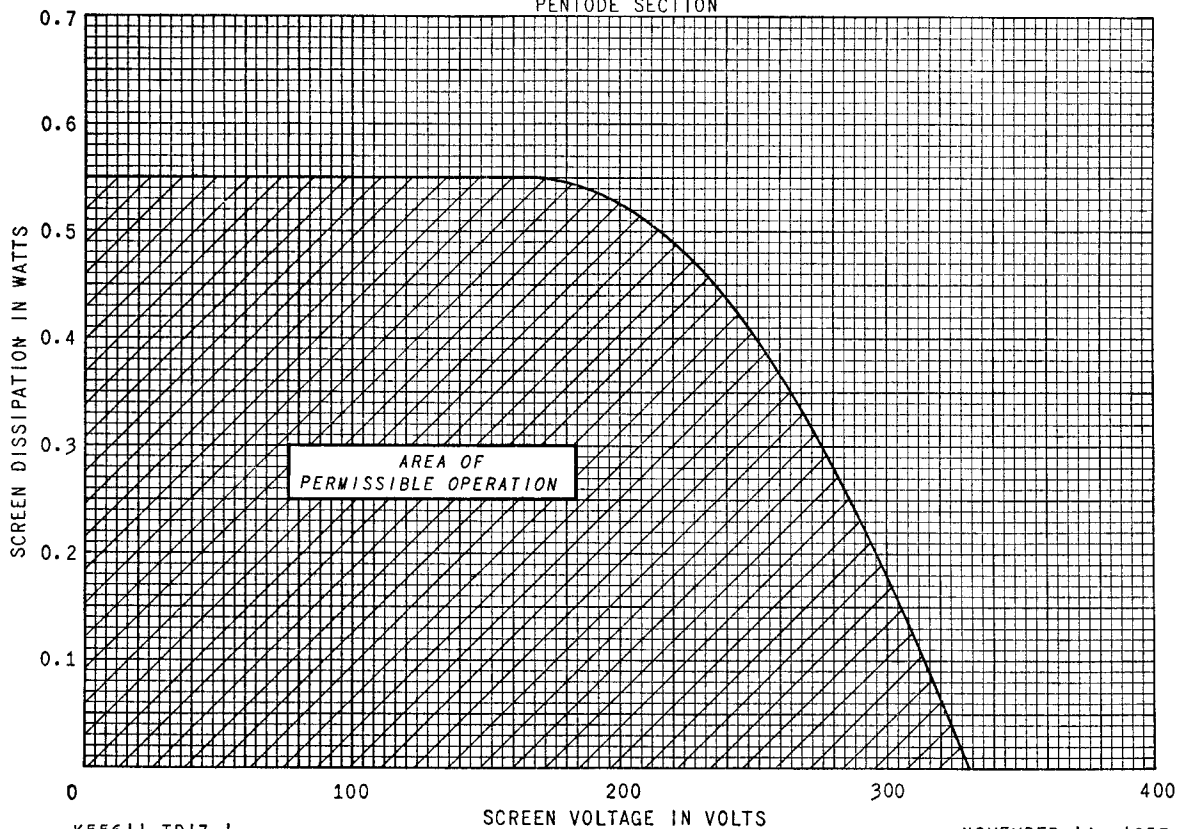

K55611-TD17-1

NOVEMBER 14, 1957

**AVERAGE PLATE CHARACTERISTICS**

PENTODE SECTION

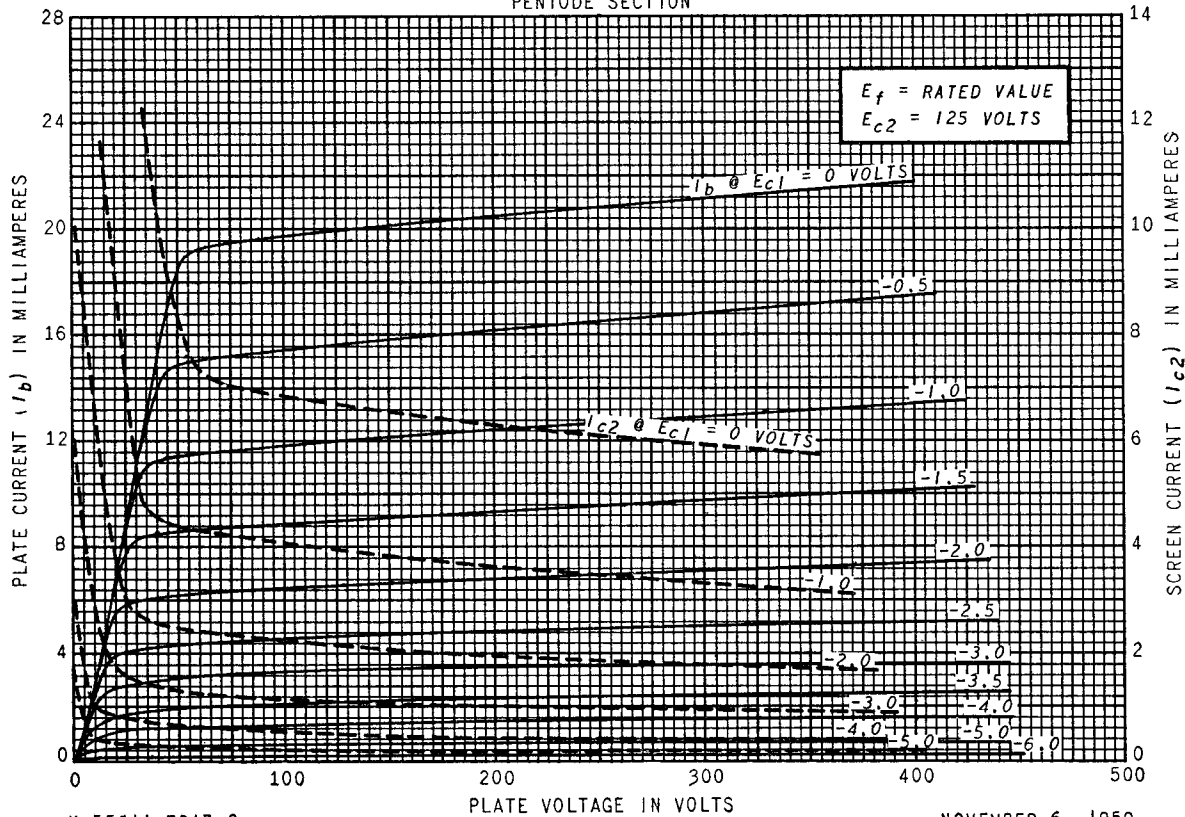

K-55611-TD17-2

NOVEMBER 6, 1959

### AVERAGE PLATE CHARACTERISTICS

PENTODE SECTION

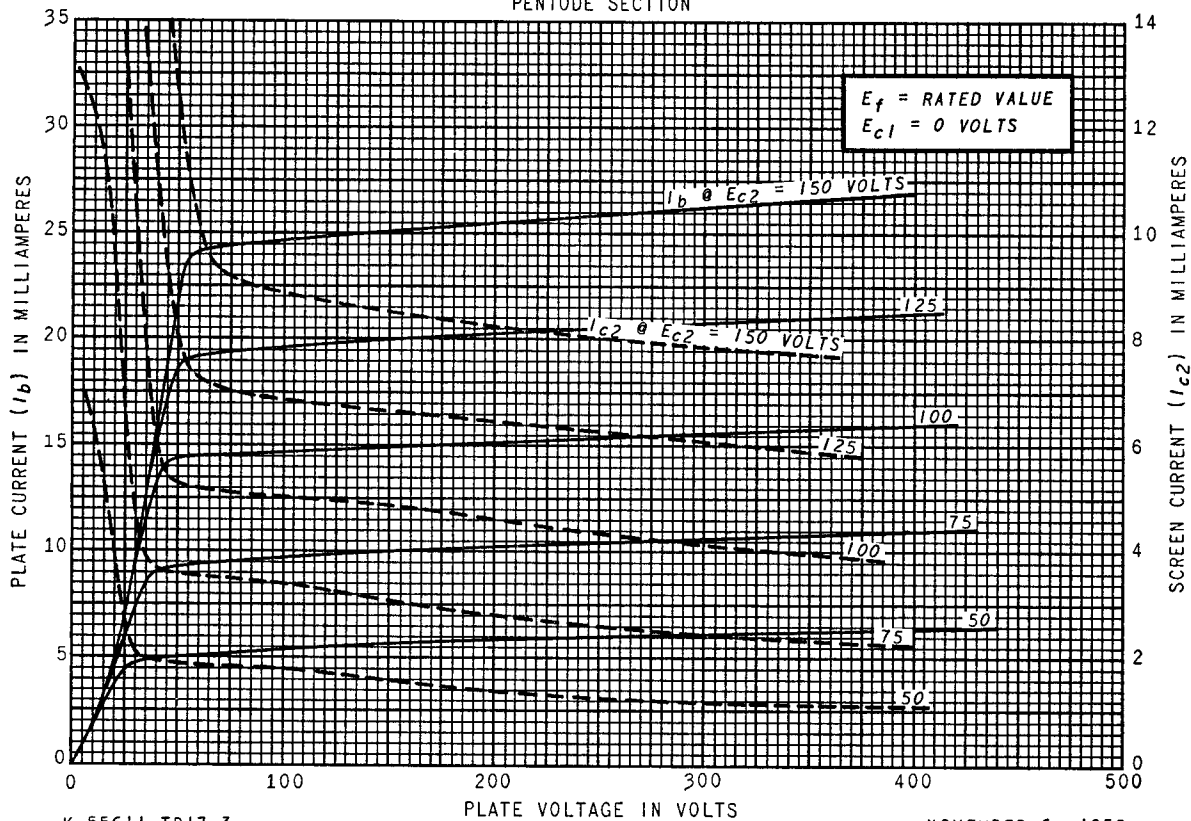

K-55611-TD17-3

NOVEMBER 6, 1959

### AVERAGE TRANSFER CHARACTERISTICS

PENTODE SECTION

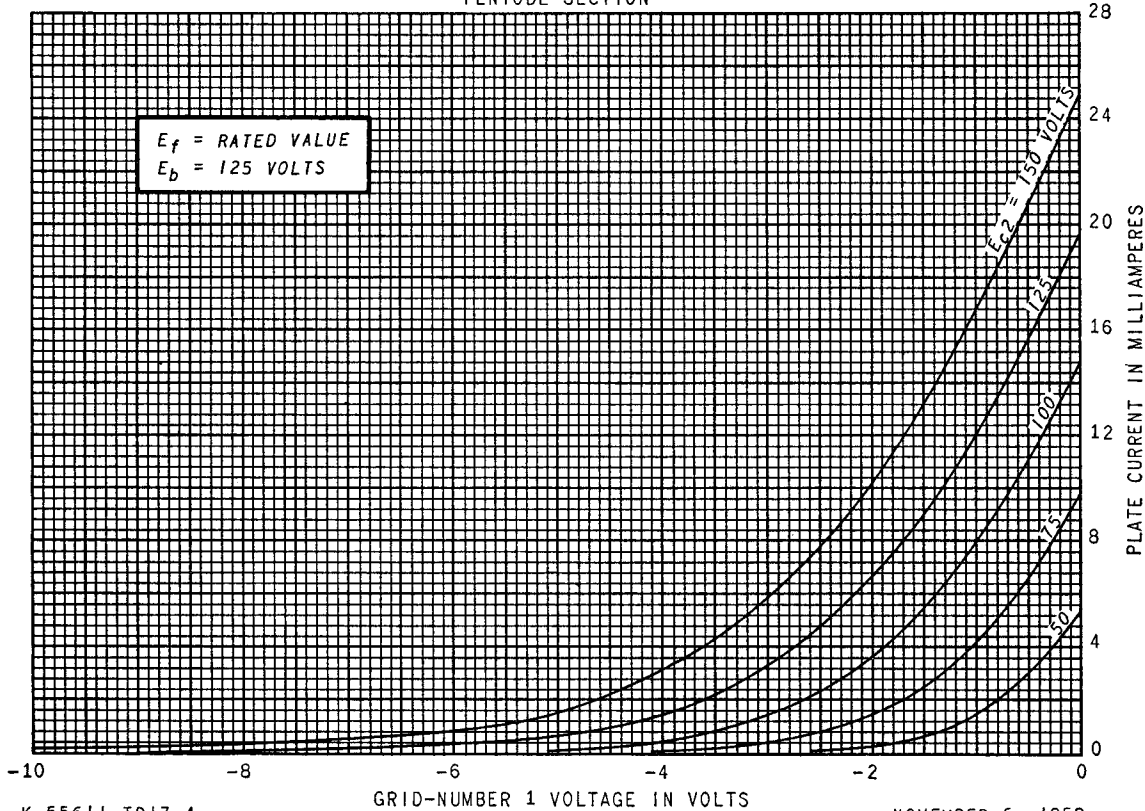

K-55611-TD17-4

NOVEMBER 6, 1959

**AVERAGE TRANSFER CHARACTERISTICS**  
 PENTODE SECTION

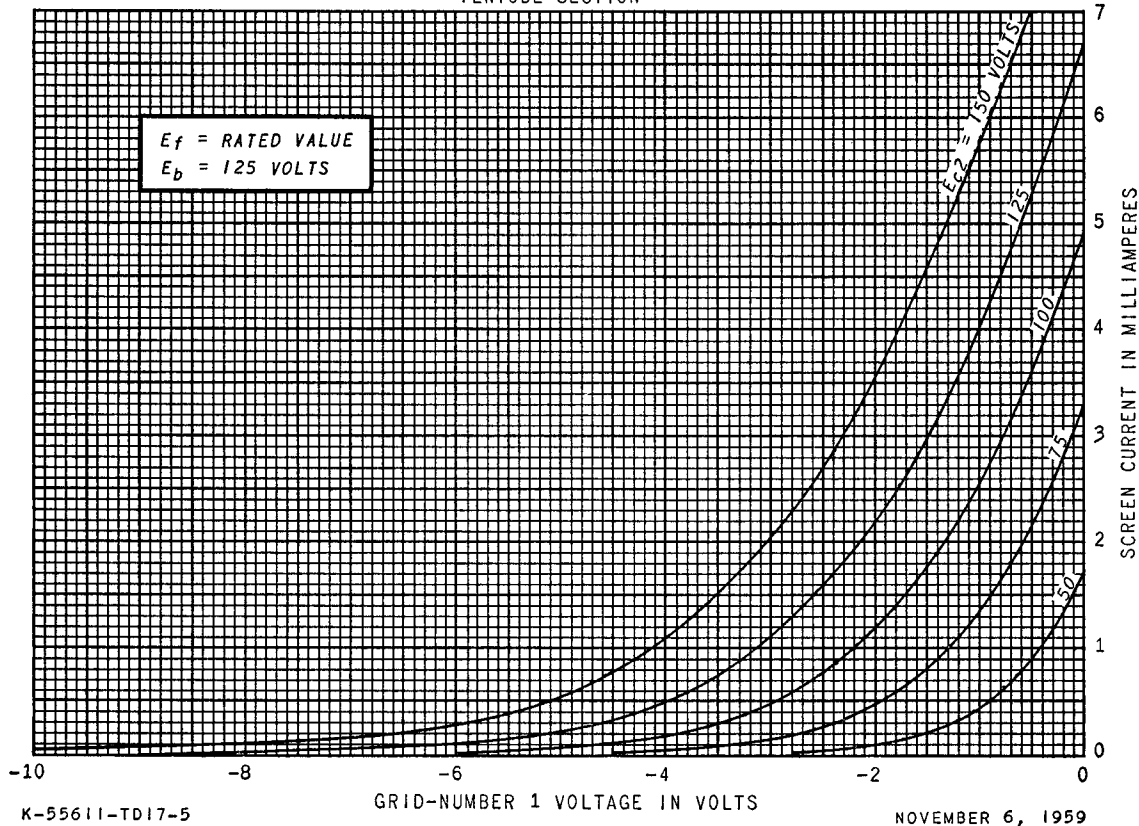

**AVERAGE TRANSFER CHARACTERISTICS**  
 PENTODE SECTION

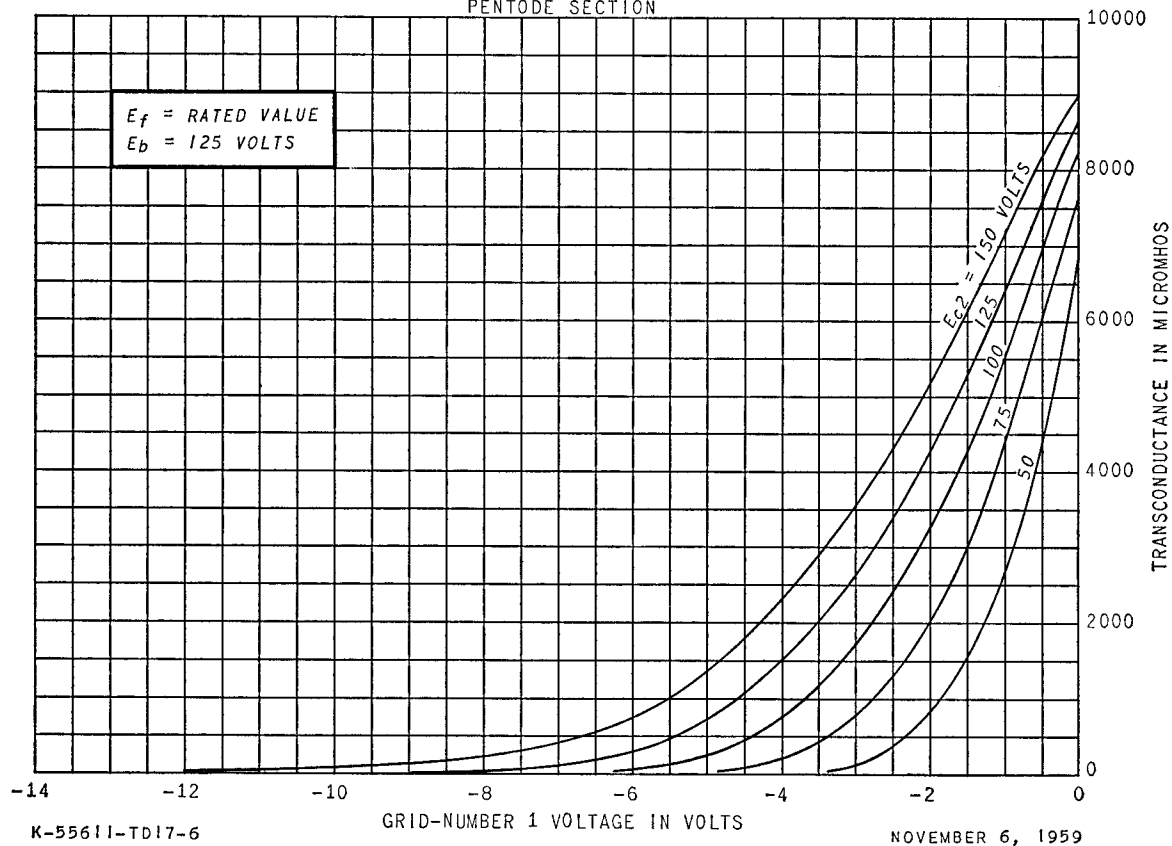

**AVERAGE PLATE CHARACTERISTICS**

TRIODE SECTION

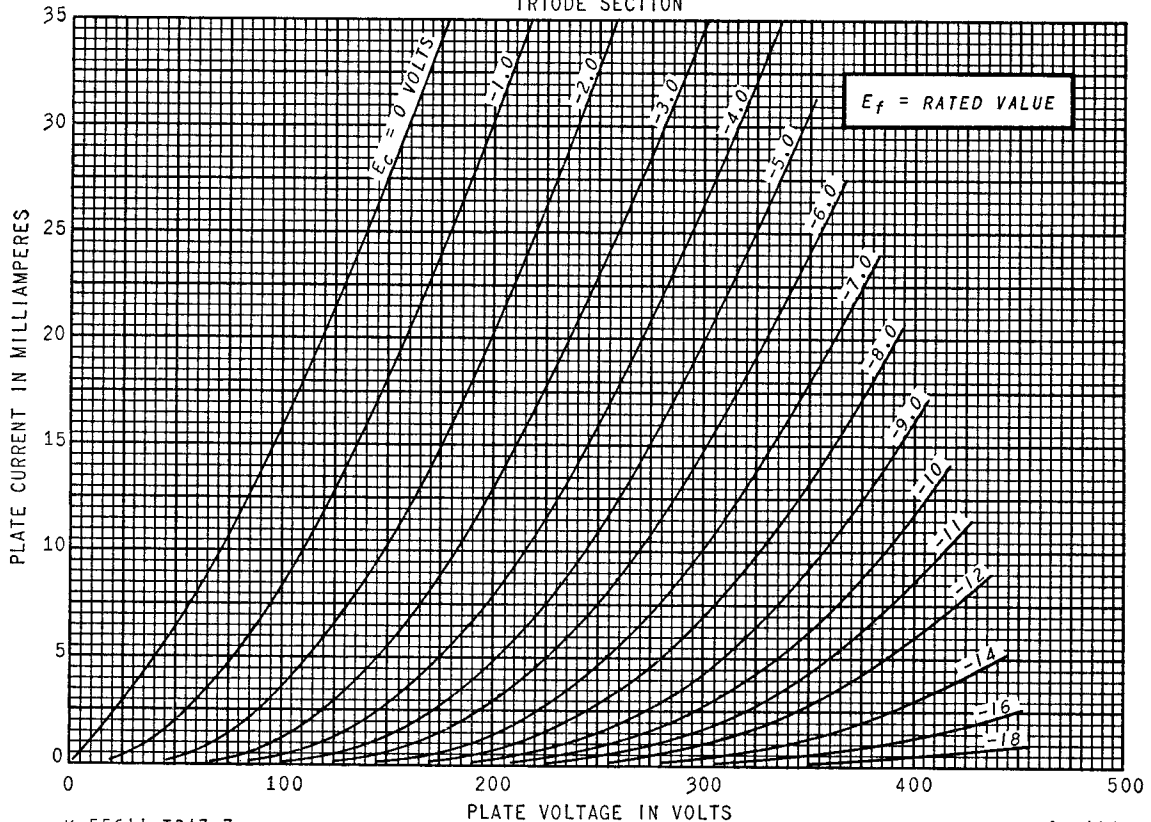

K-55611-TD17-7

NOVEMBER 6, 1959

**AVERAGE TRANSFER CHARACTERISTICS**

TRIODE SECTION

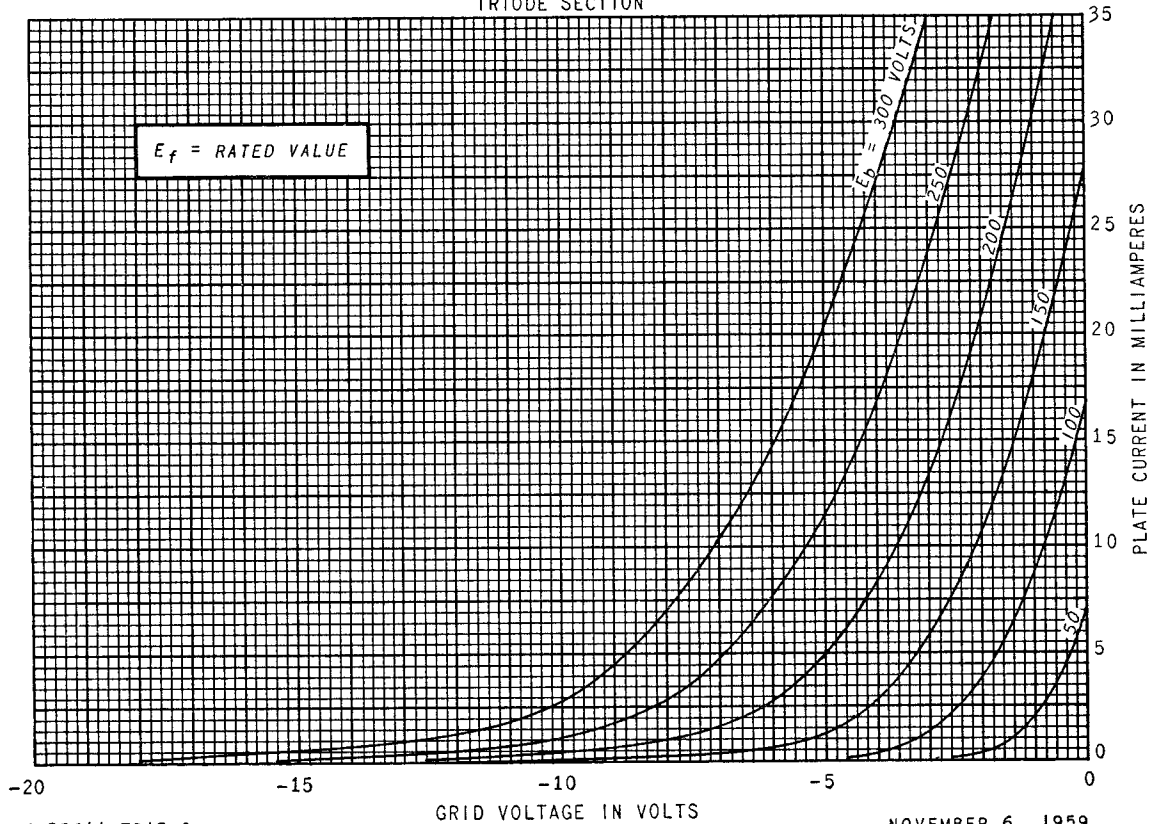

K-55611-TD17-8

NOVEMBER 6, 1959

### AVERAGE CHARACTERISTICS TRIODE SECTION

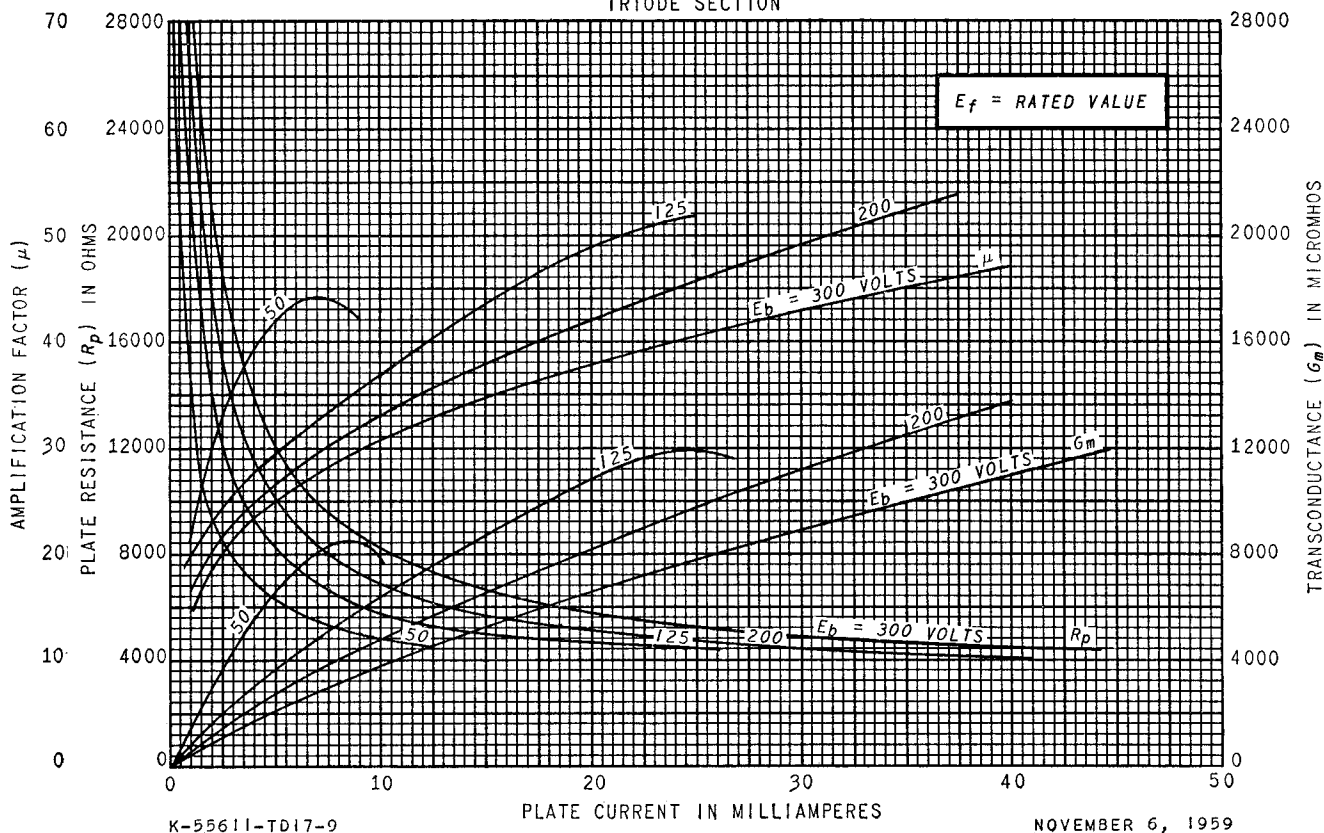

K-55611-TD17-9

NOVEMBER 6, 1959