

**Power Entry Module with RFI Power Line Filter for General or Medical Applications**

# L Series



**UL Recognized  
CSA Certified  
VDE Approved**



## L Series

The L series power entry modules are compact units that combine a multi-function power entry module and high performance RFI filtering capabilities. They are available with either a four-voltage selector or a DPST on/off switch. Both variations can be specified with North American or European fusing capabilities and are available in either flange or snap-in mounting.

These filters are UL recognized, CSA certified, and VDE approved. The L series modules offer a choice of filters for general or medical applications.

### EDL Models

The RFI filter is for general purpose applications where line-to-line and line-to-ground noise must be controlled. The filter is designed to meet the very low leakage requirements of VDE portable equipment. They are available in three current ratings.

### EHL Models

This medical filter provides susceptibility protection without the leakage current associated with line-to-ground capacitors. Designed to allow equipment to meet UL544 for patient care and non-patient care equipment, the EHL filter has a maximum leakage current of 2  $\mu$ A at 120 VAC 60 Hz. See Appendix C for more information on medical applications and UL standards.

*Note: When using the models with an IEC connector, remember that the leakage current of the companion line cord, GA400, is more significant than that of the filter - which may disqualify this line cord from use in patient care applications.*

## Voltage Selection

To change selected voltage: disconnect the power cord; open cover using a small blade screwdriver or similar tool; insert the tool into the voltage selection slot and remove wheel from unit; select desired voltage; replace wheel into unit and close cover, *making sure the selected voltage appears in connector window.*

**Note:** All models have North American or dual European fusing capability and are available in either flange or snap-in mounting.

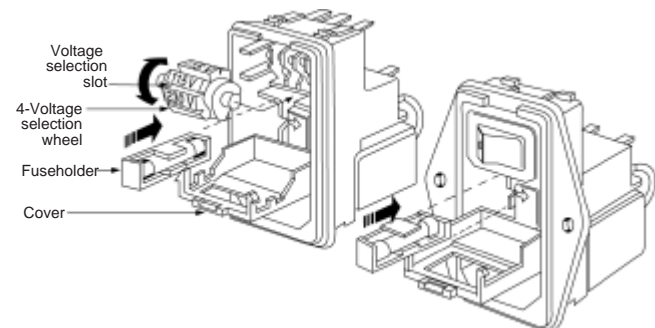

**Power Entry Module with RFI Power Line Filter for General or Medical Applications (Continued)**

# L Series

## Electrical Schematics

### DL Models (with switch)

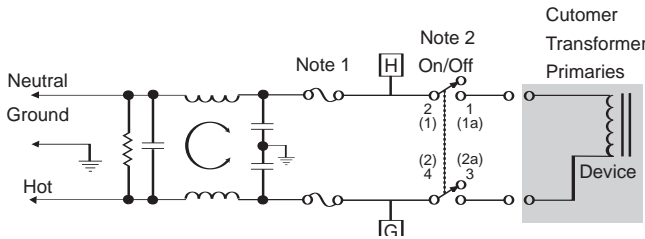

### DL Models (with 4-voltage selection)

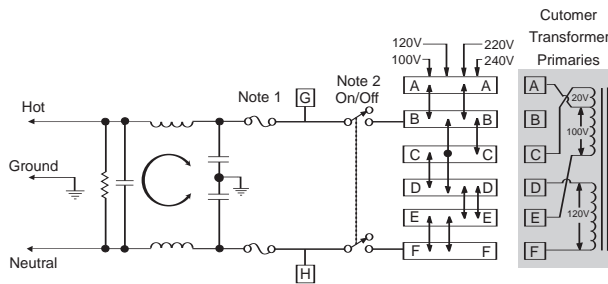

### HL Models (with switch)

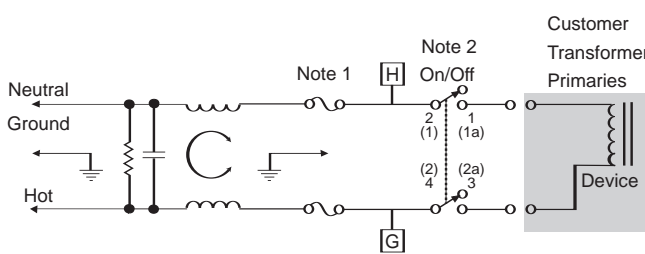

### HL Models (with 4-voltage selection)

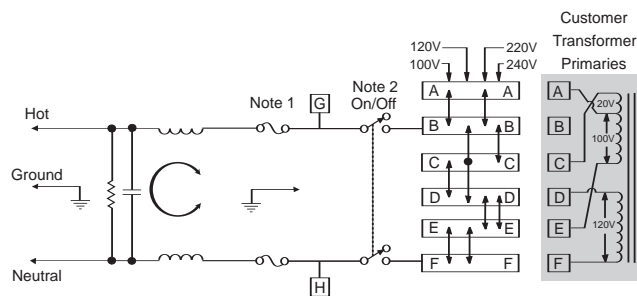

Note 1: Provision for dual European style fusing.  
Note 2: On/Off switch present only with "S" suffix.  
Resistor location for reference only.

## Specifications

Maximum leakage current, each line-to-ground:

	EDL Models	EHL Models
@120 VAC 60 Hz:	0.25 mA	2 µA
@250 VAC 50 Hz:	0.50 mA	5 µA

Hipot rating (one minute):

line-to-ground	1500	1500
line-to-line	1450	1450

Operating frequency:

50/60 Hz

Operating voltages:

1S & 1SC Suffix (fixed):	250 VAC Max.
4 & 4C Suffix (selectable):	100, 120, 220, 240 VAC

Rated current:

2EDL & 2EHL	2A
4EDL & 4EHL	4A
6EL, 6EDL & 6EHL	6A

Switch:

Double-insulated, rated for 10,000 operations at full load. 51 Amp inrush capability.

Fuse (not included):

Accepts one .25" x 1.25" fuse or two 5 x 20 mm fuses

Terminals:

110 [2.79] except for switch  
.187 [4.8] for switch

Minimum insertion loss in dB:

Line-to-ground in 50 ohm circuit

Current Rating	Frequency-MHz					
	.05	.15	1	5	10	30
<b>EDL Models</b>						
2A	6	14	24	40	45	50
4A	2	8	18	32	38	45
6A	1	6	17	31	37	45
<b>EHL Models</b>						
6A	3	8	15	18	18	18

Line-to-line in 50 ohm circuit

Current Rating	Frequency-MHz						
	.05	.5	1	3	5	10	30
<b>EDL Models</b>							
2A	7	16	21	23	37	47	50
4A	6	14	18	23	26	45	47
6A	6	15	20	25	24	45	50
<b>EHL Models</b>							
6A	4	14	20	28	32	38	42

**Power Entry Module with RFI Power Line Filter for General  
or Medical Applications (Continued)**

# L Series

## Case Styles — Unfiltered Models

### Flange Models

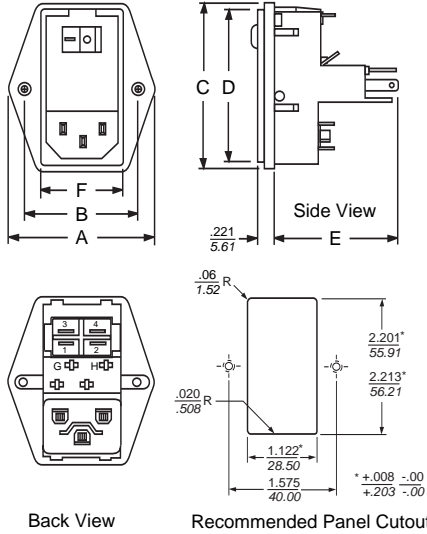

Typical dimensions:  
Mounting Holes: .126 [3.20] Dia. (2)  
All backplate terminals: .110 [2.79] terminals, except for switch.  
Switch terminals are .187 [4.765] Note: Snap-in models allow front mounting only.

### Snap-In Models

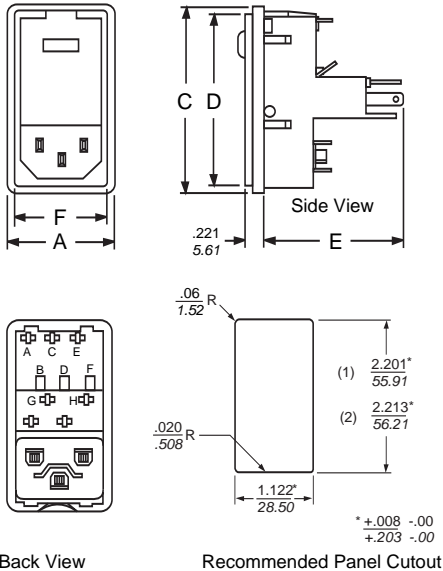

(1) For panel thickness of .031-.079 [0.8-2.0]  
(2) For panel thickness of .083-.126 [2.1-3.2]  
(3) For snap-in application, the 1.22 [28.5] sides of the cutout must have a .02 [.508] radius on the installation side.  
All backplate terminals: .110 [2.79] terminals, except for switch. Switch terminals are .187 [4.75]  
Note: Snap-in models allow front mounting only.

## Case Styles — Filtered Models

### Flange Models

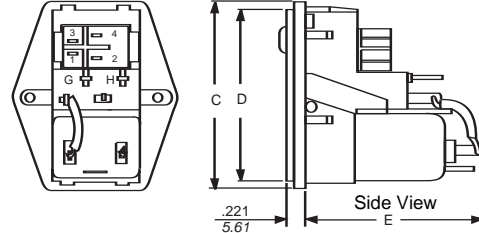

### Snap-In Models

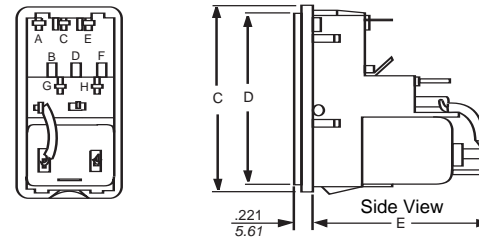

Note: Metric fuse models have additional jumper from filter-to-module.

## Case Dimensions

Part No.	A (max)	B <i>±.015</i> <i>±.381</i>	C (max)	D (max)	E (max)	F (max)
Flange	<b>1.98</b>	<b>1.575</b>	<b>2.3</b>	<b>2.14</b>	<b>1.66</b>	<b>1.11</b>
Unfiltered	<i>50.29</i>	<i>40.0</i>	<i>58.42</i>	<i>54.36</i>	<i>42.16</i>	<i>28.19</i>
Snap-in	<b>1.28</b>	—	<b>2.3</b>	<b>2.14</b>	<b>1.66</b>	<b>1.11</b>
Unfiltered	<i>32.51</i>	—	<i>58.42</i>	<i>54.36</i>	<i>42.16</i>	<i>28.19</i>
Flange	<b>1.98</b>	<b>1.575</b>	<b>2.3</b>	<b>2.14</b>	<b>2.01</b>	<b>1.11</b>
Filtered	<i>50.29</i>	<i>40.0</i>	<i>58.42</i>	<i>54.36</i>	<i>51.05</i>	<i>28.19</i>
Snap-in	<b>1.28</b>	—	<b>2.3</b>	<b>2.14</b>	<b>2.01</b>	<b>1.11</b>
Filtered	<i>32.51</i>	—	<i>58.42</i>	<i>54.36</i>	<i>51.05</i>	<i>28.19</i>

Power Entry Module with RFI Power Line Filter for General or Medical Applications (Continued)

# L Series

## UNFILTERED MODELS

Part Number	Current Rating	Available Voltage Selection Position	DPST On/Off Switch	Mounting Style	Fuseholder Type
6EL1S	6A	1	•	Flange	North American
6EL1SC	6A	1	•	Snap-In	North American
6EL1SM	6A	1	•	Flange	Metric
6EL1SCM	6A	1	•	Snap-In	Metric
6EL4	6A	4		Flange	North American
6EL4C	6A	4		Snap-In	North American
6EL4M	6A	4		Flange	Metric
6EL4CM	6A	4		Snap-in	Metric

## FILTERED MODELS

Part Number	Filter Type	Current Rating	Available Voltage Selection Position	DPST On/Off Switch	Mounting Style	Fuseholder Type
2EDL1S	Linear	2A	1	•	Flange	North American
2EDL1SC	Linear	2A	1	•	Snap-In	North American
2EDL1SM	Linear	2A	1	•	Flange	Metric
2EDL1SCM	Linear	2A	1	•	Snap-In	Metric
2EDL4	Linear	2A	4		Flange	North American
2EDL4C	Linear	2A	4		Snap-In	North American
2EDL4M	Linear	2A	4		Flange	Metric
2EDL4CM	Linear	2A	4		Snap-in	Metric
4EDL1S	Linear	4A	1	•	Flange	North American
4EDL1SC	Linear	4A	1	•	Snap-in	North American
4EDL1SM	Linear	4A	1	•	Flange	Metric
4EDL1SCM	Linear	4A	1	•	Snap-in	Metric
4EDL4	Linear	4A	4		Flange	North American
4EDL4C	Linear	4A	4		Snap-in	North American
4EDL4M	Linear	4A	4		Flange	Metric
4EDL4CM	Linear	4A	4		Snap-in	Metric
6EDL1S	Linear	6A	1	•	Flange	North American
6EDL1SC	Linear	6	1	•	Flange	North American
6EDL1SM	Linear	6	1	•	Flange	Metric
6EDL1SCM	Linear	6	1	•	Snap-in	Metric
6EDL4	Linear	6	4		Flange	North American
6EDL4C	Linear	6	4		Snap-in	North American
6EDL4M	Linear	6	4		Flange	Metric
6EDL4CM	Linear	6	4		Snap-in	Metric
6EHL1S	Medical	6	1	•	Flange	North American
6EHL1SC	Medical	6	1	•	Snap-in	North American
6EHL1SM	Medical	6	1	•	Flange	Metric
6EHL1SCM	Medical	6	1	•	Snap-in	Metric
6EHL4	Medical	6	4		Flange	North American
6EHL4C	Medical	6	4		Snap-in	North American
6EHL4M	Medical	6	4		Flange	Metric
6EHL4CM	Medical	6	4		Snap-in	Metric

• Includes DPST switch