

IGBT MODULE (U series) 600V / 150A



■ Features

- Low $V_{CE(sat)}$
- Compact Package
- P.C. Board Mount Module

■ Applications

- Inverter for Motoe Drive
- AC and DC Servo Drive Amplifier
- Uninterruptible Power Supply

■ Maximum ratings and characteristics

● Absolute maximum ratings ($T_c=25^{\circ}\text{C}$ unless otherwise specified)

Item	Symbol	Condition	Rating	Unit
Collector-Emitter voltage	V_{CES}		600	V
Gate-Emitter voltage	V_{GES}		± 20	V
Collector current	I_c	Continuous	150	A
	I_{cP}	1ms	300	
	$-I_c$		150	
	$-I_c$ pulse		300	
Collector power dissipation	P_c	1 device	500	W
Operating junction temperature	T_j		+150	$^{\circ}\text{C}$
Storage temperature	T_{stg}		-40 to +125	$^{\circ}\text{C}$
Isolation voltage	V_{iso}	AC : 1 minute	AC 2500	V
			AC 2500	V
Mounting screw torque			3.5 *1	N·m

*1 Recommendable value : 2.5 to 3.5 N·m (M5)

*2 All terminals should be connected together when isolation test will be done.

*3 Two thermistor terminals should be connected together, each other terminals should be connected together and shorted to base plate when isolation test will be done.

● Electrical characteristics (Tj=25°C unless otherwise specified)

Item	Symbol	Condition	Characteristics			Unit	
			Min.	Typ.	Max.		
Zero gate voltage collector current	ICES	VCE=600V, VGE=0V	-	-	1.0	mA	
Gate-Emitter leakage current	IGES	VCE=0V, VGE=±20V	-	-	200	nA	
Gate-Emitter threshold voltage	VGE(th)	VCE=20V, Ic=150mA	6.2	6.7	7.7	V	
Collector-Emitter saturation voltage	VCE(sat) (terminal)	VGE=15V Ic=150A	Tj=25°C	-	2.30	2.60	V
			Tj=125°C	-	2.55	-	
	VCE(sat) (chip)		Tj=25°C	-	1.80	-	
			Tj=125°C	-	2.05	-	
Input capacitance	Cies	VGE=0V, VCE=10V, f=1MHz	-	12	-	nF	
Turn-on time	ton	VCC=300V Ic=150A VGE=±15V	-	0.40	1.20	µs	
	tr		-	0.22	0.60		
	tr(i)		-	0.16	-		
	toff		-	0.48	1.20		
Turn-off time	tr	RG= 24 Ω	-	0.07	0.45		
Forward on voltage	VF (terminal)	VGE= 0 V IF=150A	Tj=25°C	-	2.10	2.45	V
			Tj=125°C	-	2.15	-	
	VF (chip)		Tj=25°C	-	1.60	-	
			Tj=125°C	-	1.65	-	
Reverse recovery time of FRD	trr	IF=150A	-	-	0.35	µs	
Lead resistance, terminal-chip *	R lead		-	3.4	-	mΩ	
Thermistor	Resistance	T=25°C	-	5000	-	Ω	
		T=100°C	465	495	520		
B value	B	T=25/50°C	3305	3375	3450	K	

* Biggest internal terminal resistance among arm.

● Thermal resistance Characteristics

Item	Symbol	Condition	Characteristics			Unit
			Min.	Typ.	Max.	
Thermal resistance (1 device)	Rth(j-c)	IGBT	-	-	0.25	°C/W
		FWD	-	-	0.48	
Contact thermal resistance *	Rth(c-f)	With thermal compound	-	0.05	-	

* This is the value which is defined mounting on the additional cooling fin with thermal compound

■ Equivalent Circuit Schematic

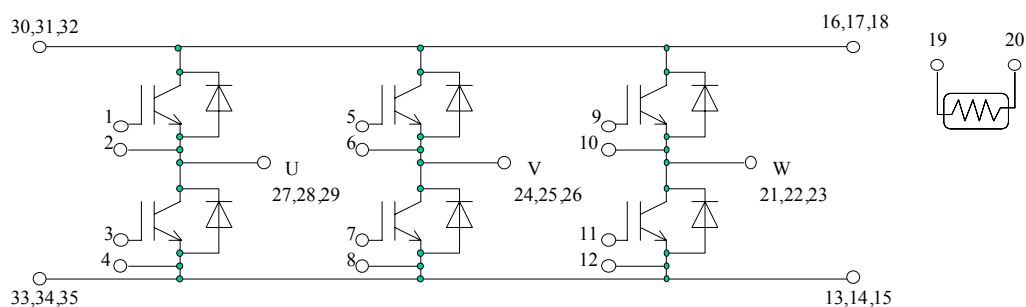

■ Characteristics (Representative)

Collector current vs. Collector-Emittor voltage (typ.)
Tj= 25°C / chip

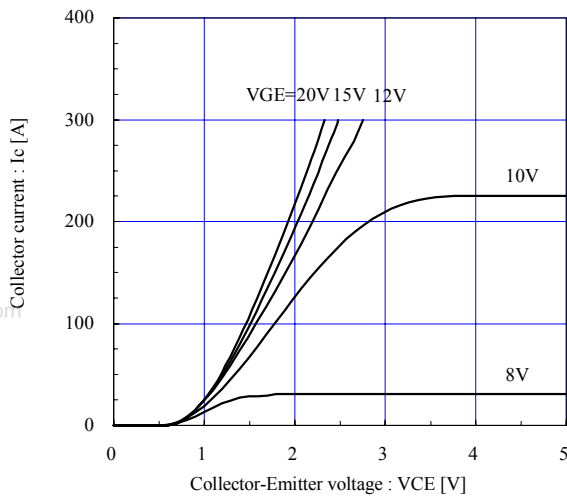

Collector current vs. Collector-Emittor voltage (typ.)
Tj= 125°C / chip

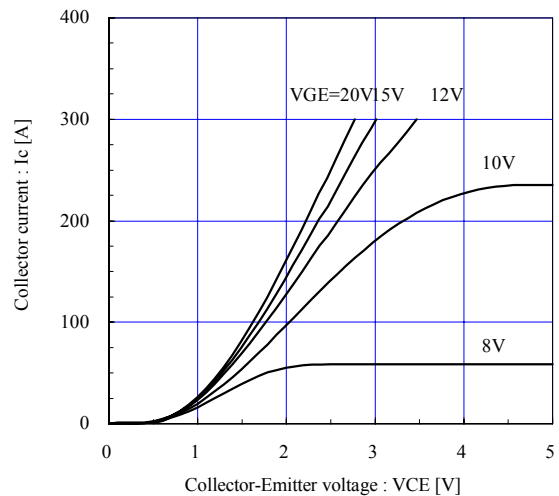

Collector current vs. Collector-Emittor voltage (typ.)
VGE=15V / chip

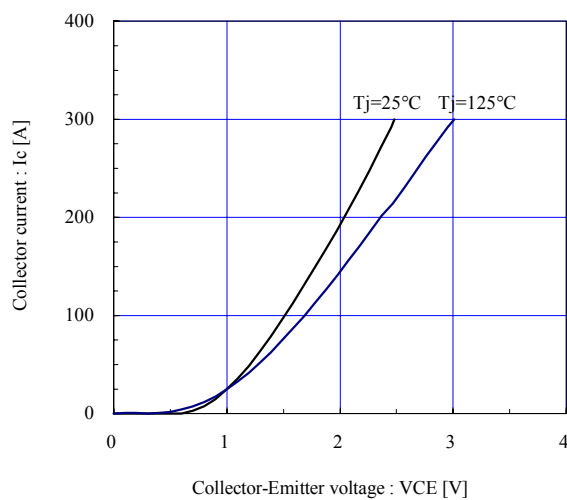

Collector-Emittor voltage vs. Gate-Emittor voltage (typ.)
Tj=25°C / chip

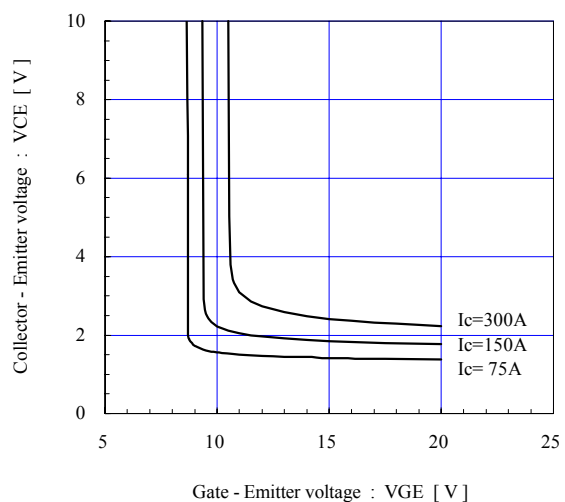

Capacitance vs. Collector-Emittor voltage (typ.)
VGE=0V, f= 1MHz, Tj= 25°C

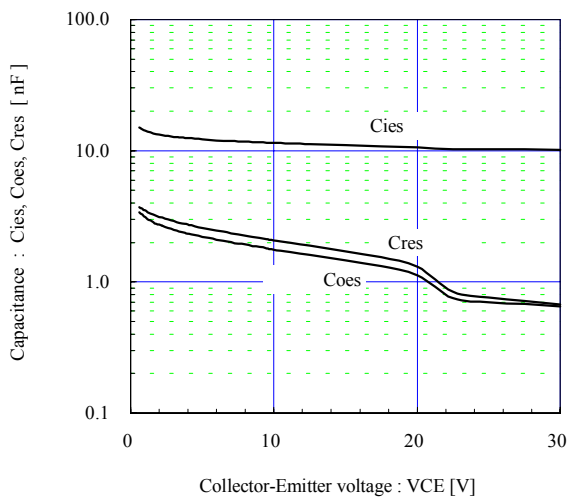

Dynamic Gate charge (typ.)
Vcc=300V, Ic=150A, Tj= 25°C

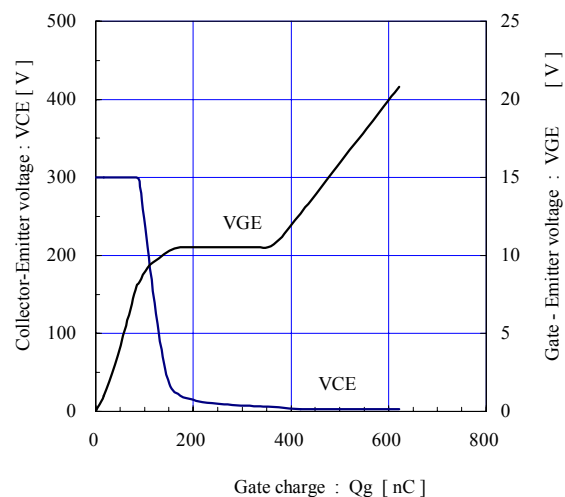

Switching time vs. Collector current (typ.)
 $V_{cc}=300V, V_{GE}=\pm 15V, R_g=24\Omega, T_j=25^\circ C$

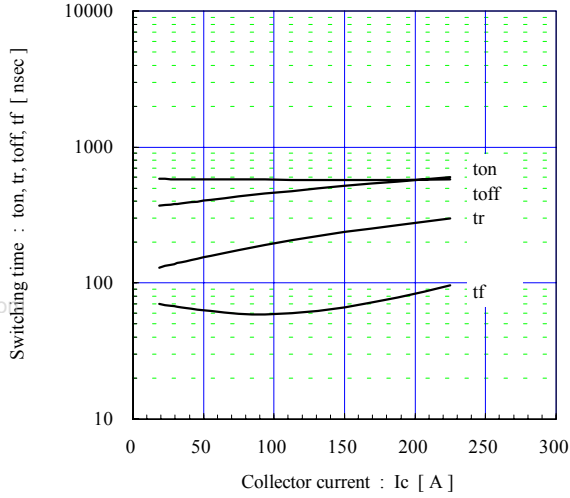

Switching time vs. Collector current (typ.)
 $V_{cc}=300V, V_{GE}=\pm 15V, R_g=24\Omega, T_j=125^\circ C$

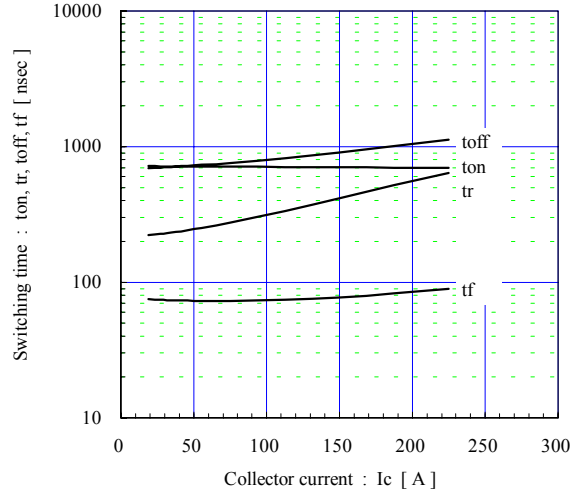

Switching time vs. Gate resistance (typ.)
 $V_{cc}=300V, I_c=150A, V_{GE}=\pm 15V, T_j=25^\circ C$

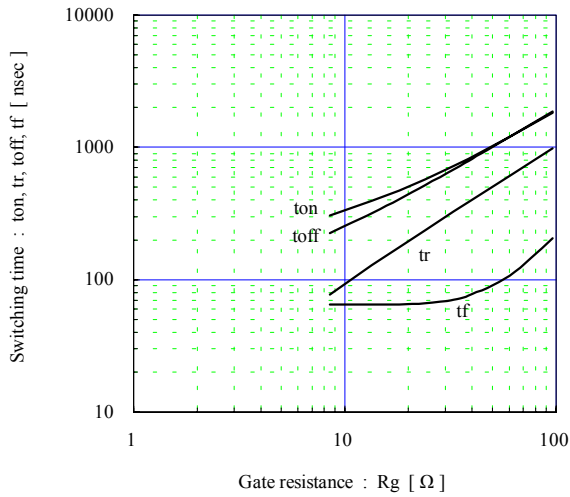

Switching loss vs. Collector current (typ.)
 $V_{cc}=300V, V_{GE}=\pm 15V, R_g=24\Omega$

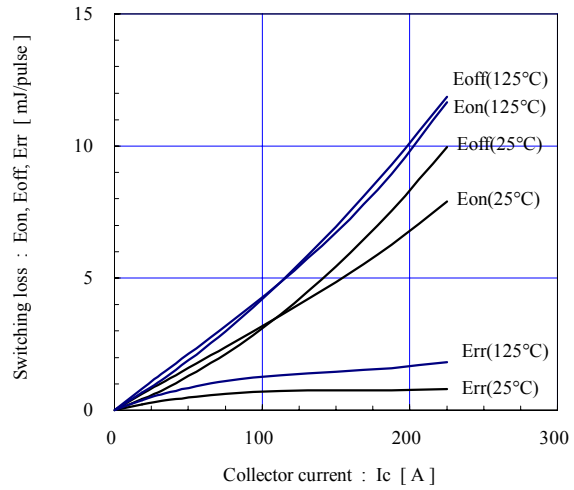

Switching loss vs. Gate resistance (typ.)
 $V_{cc}=300V, I_c=150A, V_{GE}=\pm 15V, T_j=125^\circ C$

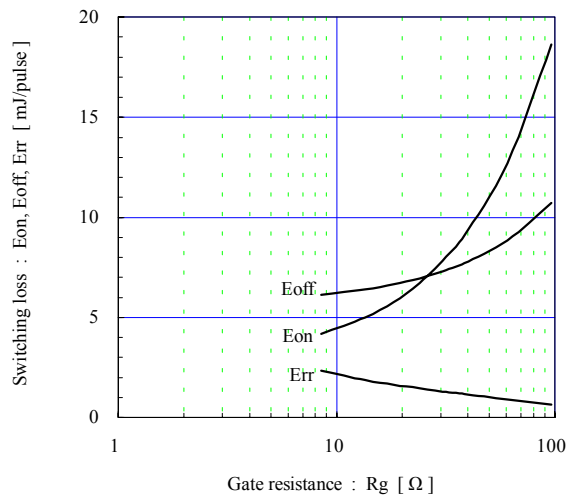

Reverse bias safe operating area (max.)
 $+V_{GE}=15V, -V_{GE} \le 15V, R_g \ge 24\Omega, T_j \le 125^\circ C$

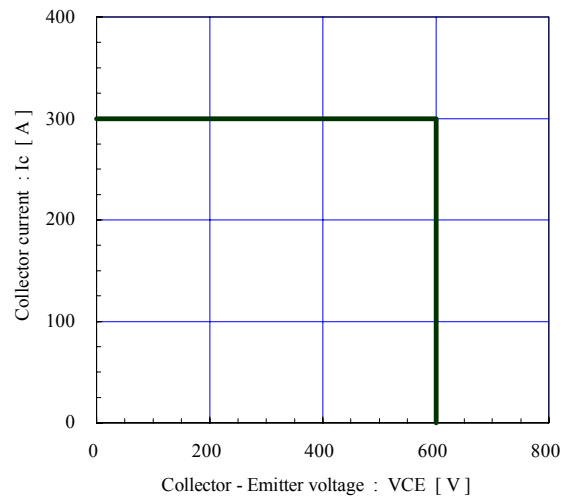

Forward current vs. Forward on voltage (typ.)
chip

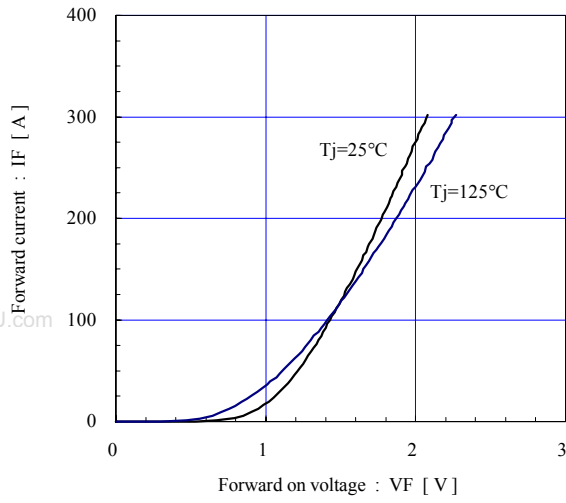

Reverse recovery characteristics (typ.)
 $V_{cc}=300\text{V}$, $V_{GE}=\pm 15\text{V}$, $R_g=24\Omega$

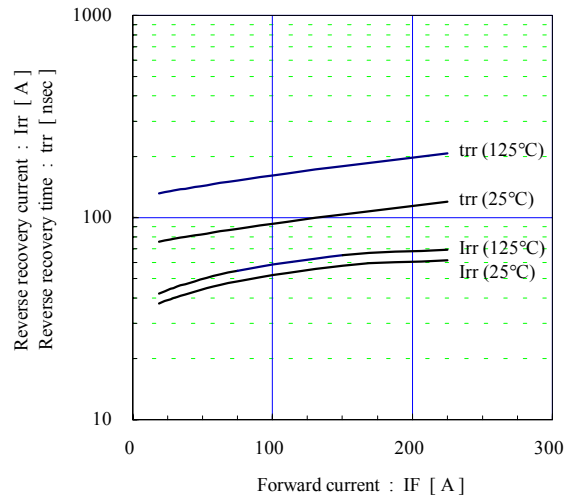

Transient thermal resistance (max.)

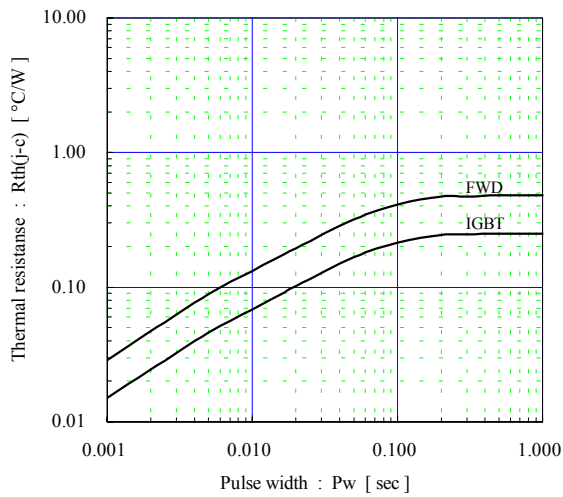

Temperature characteristic (typ.)

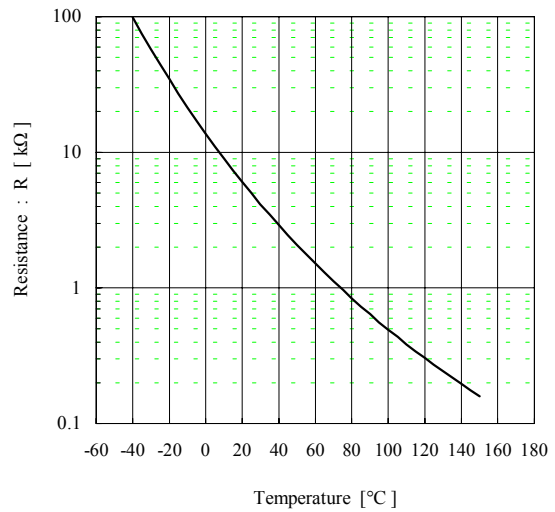

■ Outline Drawings, mm

