

# 6MBP50TEA120

## Econo IPM series

1200V / 50A 6 in one-package

### ■ Features

- Temperature protection provided by directly detecting the junction temperature of the IGBTs
- Low power loss and soft switching
- High performance and high reliability IGBT with overheating protection
- Higher reliability because of a big decrease in number of parts in built-in control circuit



### ■ Maximum ratings and characteristics

- Absolute maximum ratings(at Tc=25°C unless otherwise specified)

Item	Symbol	Rating		Unit		
		Min.	Max.			
Bus voltage	DC	V <sub>DC</sub>	0	900	V	
	Surge	V <sub>DC(surge)</sub>	0	1000	V	
	Short operating	V <sub>SC</sub>	400	800	V	
Collector-Emitter voltage *1	V <sub>CES</sub>	0	1200	V		
Inverter	Collector current	DC	I <sub>C</sub>	-	50	A
		1ms	I <sub>CP</sub>	-	100	A
		DC	-I <sub>C</sub>	-	50	A
	Collector power dissipation	One transistor *3	P <sub>C</sub>	-	287	W
Supply voltage of Pre-Driver *4	V <sub>CC</sub>	-0.5	20	V		
Input signal voltage *5	V <sub>in</sub>	-0.5	V <sub>CC</sub> +0.5	V		
Input signal current	I <sub>in</sub>	-	3	mA		
Alarm signal voltage *6	V <sub>ALM</sub>	-0.5	V <sub>CC</sub>	V		
Alarm signal current *7	I <sub>ALM</sub>	-	20	mA		
Junction temperature	T <sub>j</sub>	-	150	°C		
Operating case temperature	T <sub>opr</sub>	-20	100	°C		
Storage temperature	T <sub>stg</sub>	-40	125	°C		
Solder temperature *8	T <sub>sol</sub>	-	260	°C		
Isolating voltage (Terminal to base, 50/60Hz sine wave 1min.)	V <sub>iso</sub>	-	AC2500	V		
Screw torque	Mounting (M5)	-	3.5	N·m		

#### Note

\*1 : V<sub>CES</sub> shall be applied to the input voltage between terminal P and U or ,V or W, N and U or V or W

\*2 :  $125^{\circ}\text{C}/\text{FWD } R_{\text{th(j-c)}}/(I_{\text{c}} \times V_{\text{F MAX}})=125/0.86/(50 \times 2.0) \times 100 > 100\%$

\*3 :  $P_{\text{C}}=125^{\circ}\text{C}/\text{IGBT } R_{\text{th(j-c)}}=125/0.44=287\text{W}$  [Inverter]

\*4 : V<sub>CC</sub> shall be applied to the input voltage between terminal No.4 and 1, 8 and 5, 12 and 9, 14 and 13

\*5 : V<sub>in</sub> shall be applied to the input voltage between terminal No.3 and 1, 7 and 5, 11 and 9, 16,17,18 and 13.

\*6 : V<sub>ALM</sub> shall be applied to the voltage between terminal No.2 and 1, No6 and 5, No10 and 9, No.19 and 13.

\*7 : I<sub>ALM</sub> shall be applied to the input current to terminal No.2,6,10 and 19.

\*8 : Immersion time 10±1sec.

● **Electrical characteristics** (at  $T_c=T_j=25^\circ\text{C}$ ,  $V_{cc}=15\text{V}$  unless otherwise specified.)

**Main circuit**

Item		Symbol	Condition	Min.	Typ.	Max.	Unit	
Inverter	Collector current at off signal input	$I_{CES}$	$V_{CE}=1200\text{V}$ $V_{in}$ terminal open.	-	-	1.0	mA	
	Collector-Emitter saturation voltage	$V_{CE(sat)}$	$I_c=50\text{A}$	Terminal	-	-	3.1	V
				Chip	-	2.2	-	
	Forward voltage of FWD	$V_F$	$-I_c=50\text{A}$	Terminal	-	-	2.0	V
Chip				-	1.6	-		
Turn-on time	$t_{on}$	$V_{DC}=600\text{V}, T_j=125^\circ\text{C}$		1.2	-	-	$\mu\text{s}$	
Turn-off time	$t_{off}$	$I_c=50\text{A}$ Fig.1, Fig.6		-	-	3.6		
Reverse recovery time	$t_{rr}$	$V_{DC}=600\text{V}, I_F=50\text{A}$ Fig.1, Fig.6		-	-	0.3		

● **Control circuit**

Item	Symbol	Condition	Min.	Typ.	Max.	Unit
Supply current of P-line side pre-driver(one unit)	$I_{ccp}$	Switching Frequency : 0 to 15kHz $T_c=-20$ to $125^\circ\text{C}$ Fig.7	-	-	15	mA
Supply current of N-line side pre-driver	$I_{ccn}$		-	-	45	mA
Input signal threshold voltage (on/off)	$V_{in(th)}$	ON	1.00	1.35	1.70	V
		OFF	1.25	1.60	1.95	V
Input zener voltage	$V_Z$	$R_{in}=20\text{k}\Omega$	-	8.0	-	V
Alarm signal hold time	$t_{ALM}$	$T_c=-20^\circ\text{C}$ Fig.2	1.1	-	-	ms
		$T_c=25^\circ\text{C}$ Fig.2	-	2.0	-	ms
		$T_c=125^\circ\text{C}$ Fig.2	-	-	4.0	ms
Current limit resistor	$R_{ALM}$	Alarm terminal	1425	1500	1575	$\Omega$

● **Protection Section** ( $V_{cc}=15\text{V}$ )

Item	Symbol	Condition	Min.	Typ.	Max.	Unit
Over Current Protection Level of Inverter circuit	$I_{OC}$	$T_j=125^\circ\text{C}$	75	-	-	A
Over Current Protection Delay time	$t_{DOC}$	$T_j=125^\circ\text{C}$	-	5	-	$\mu\text{s}$
SC Protection Delay time	$t_{SC}$	$T_j=125^\circ\text{C}$ Fig.4	-	-	8	$\mu\text{s}$
IGBT Chip Over Heating Protection Temperature Level	$T_{jOH}$	Surface of IGBT chips	150	-	-	$^\circ\text{C}$
Over Heating Protection Hysteresis	$T_{jH}$		-	20	-	$^\circ\text{C}$
Under Voltage Protection Level	$V_{UV}$		11.0	-	12.5	V
Under Voltage Protection Hysteresis	$V_H$		0.2	0.5	-	V

● **Thermal characteristics**( $T_c=25^\circ\text{C}$ )

Item			Symbol	Min.	Typ.	Max.	Unit
Junction to Case thermal resistance *9	Inverter	IGBT	$R_{th(j-c)}$	-	-	0.44	$^\circ\text{C}/\text{W}$
		FWD	$R_{th(j-c)}$	-	-	0.86	$^\circ\text{C}/\text{W}$
Case to fin thermal resistance with compound			$R_{th(c-f)}$	-	0.05	-	$^\circ\text{C}/\text{W}$

\*9 : (For 1 device, Case is under the device)

● **Noise Immunity** ( $V_{DC}=300\text{V}$ ,  $V_{cc}=15\text{V}$ , Test Circuit Fig.5)

Item	Condition	Min.	Typ.	Max.	Unit
Common mode rectangular noise	Pulse width $1\mu\text{s}$ , polarity $\pm$ , 10minuets Judge : no over-current, no miss operating	$\pm 2.0$	-	-	kV
Common mode lightning surge	Rise time $1.2\mu\text{s}$ , Fall time $50\mu\text{s}$ Interval 20s, 10 times Judge : no over-current, no miss operating	$\pm 5.0$	-	-	kV

● **Recommendable value**

Item	Symbol	Min.	Typ.	Max.	Unit
DC Bus Voltage	$V_{DC}$	-	-	800	V
Operating Supply Voltage of Pre-Driver	$V_{cc}$	13.5	15.0	16.5	V
Screw torque (M5)	-	2.5	-	3.0	Nm

● **Weight**

Item	Symbol	Min.	Typ.	Max.	Unit
Weight	$W_t$	-	270	-	g



Figure 1. Switching Time Waveform Definitions



Fault : Over-current, Over-heat or Under-voltage

Figure 2. Input/Output Timing Diagram

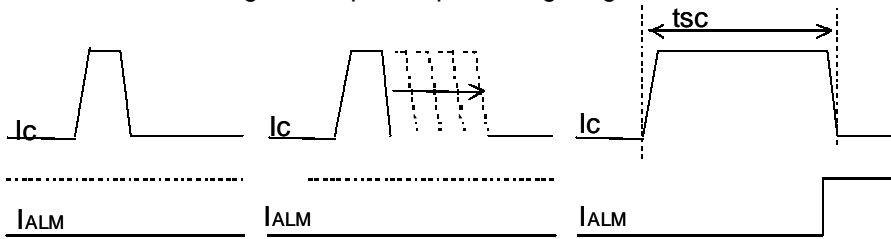

Figure.4 Definition of tsc

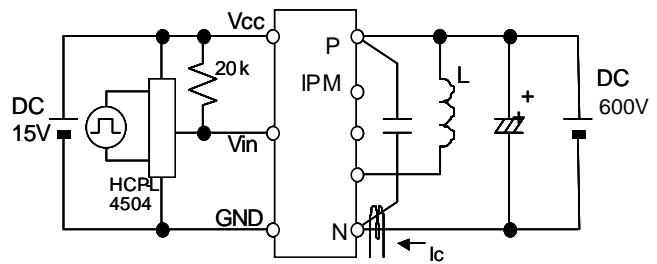

Figure 6. Switching Characteristics Test Circuit

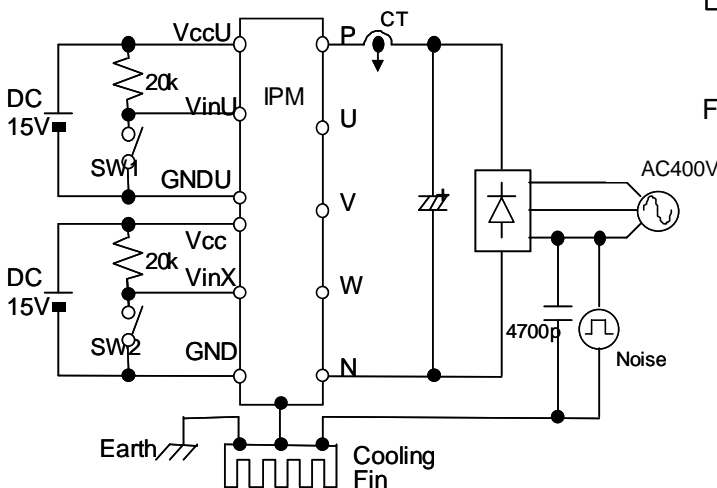

Figure 5. Noise Test Circuit

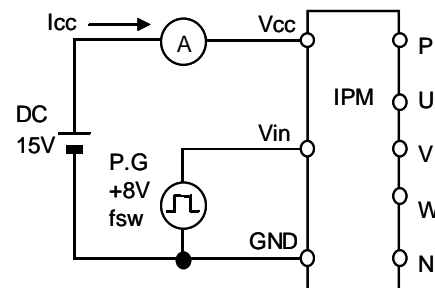
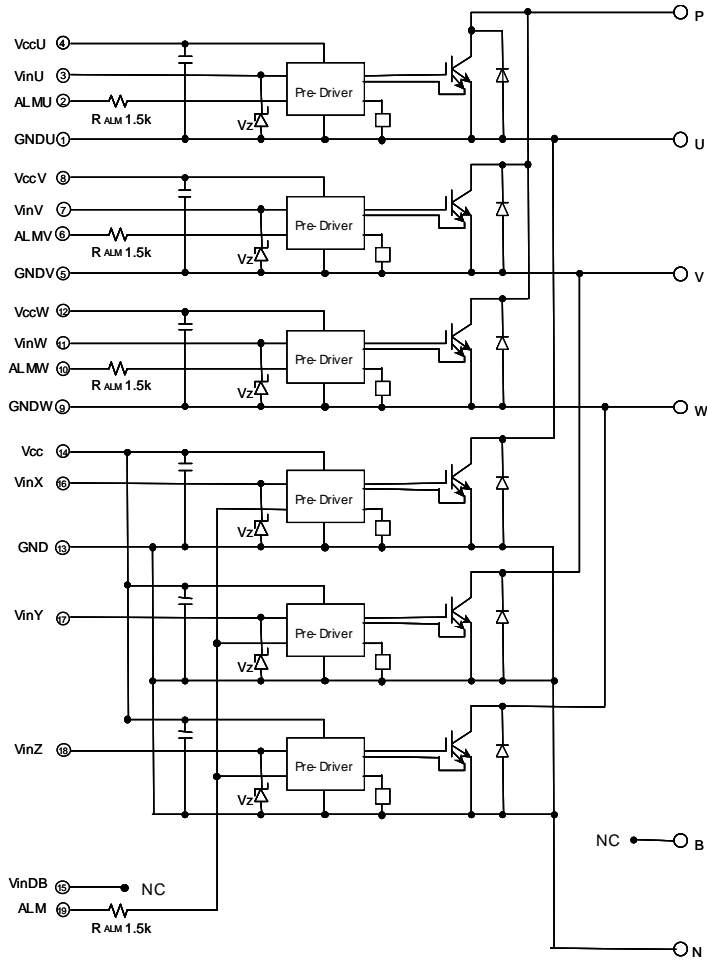

Figure 7. Icc Test Circuit

Block diagram



- Pre-drivers include following functions
1. Amplifier for driver
  2. Short circuit protection
  3. Under voltage lockout circuit
  4. Over current protection
  5. IGBT chip over heating protection

Outline drawings, mm

Package type : P622  
Dimensions in mm

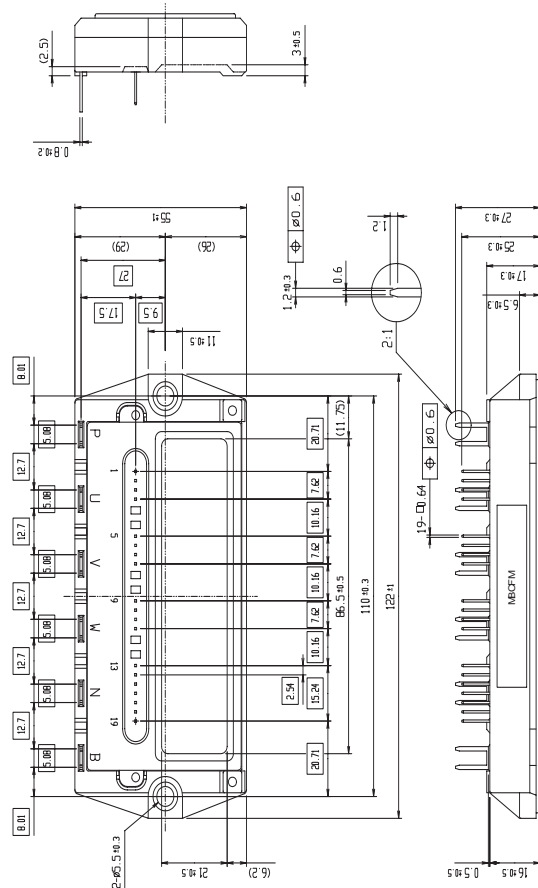

Mass : 270g

■ Characteristics

● Control circuit characteristics (Representative)

Power supply current vs. Switching frequency  
Tc=125°C (typ.)

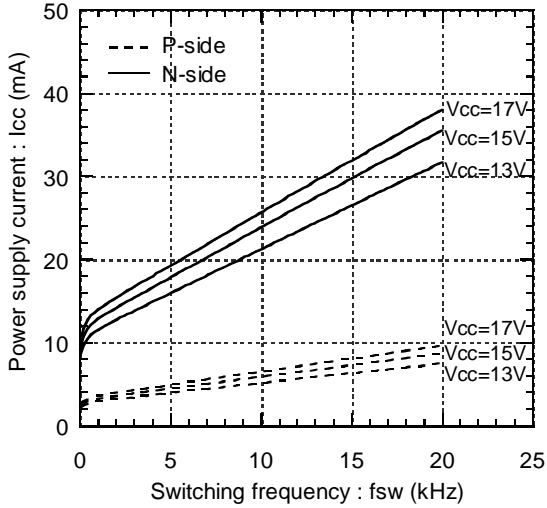

Input signal threshold voltage vs. Power supply voltage (typ.)

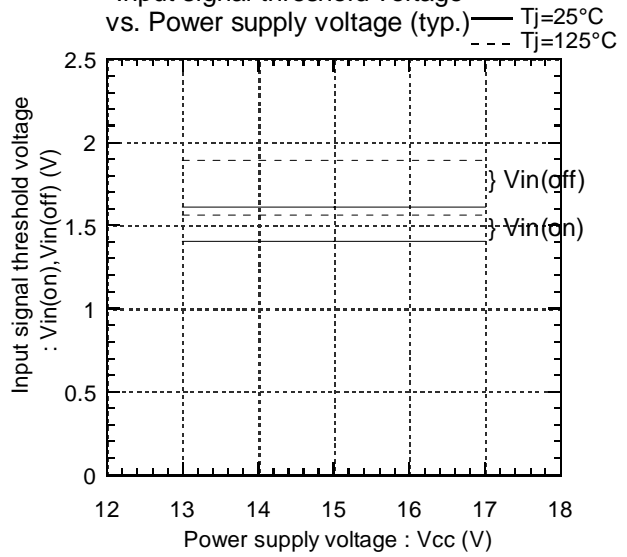

Under voltage vs. Junction temperature (typ.)

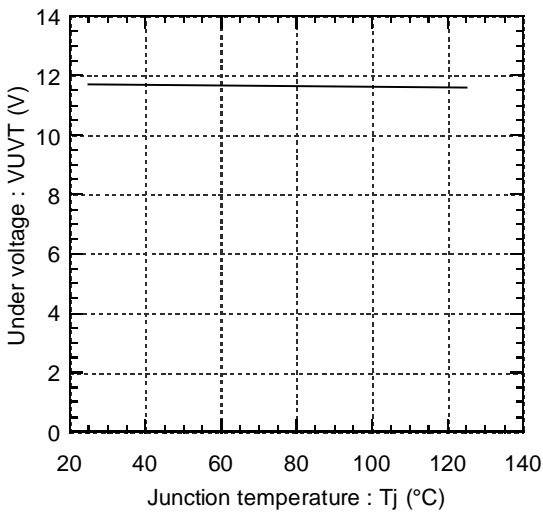

Under voltage hysteresis vs. Junction temperature (typ.)

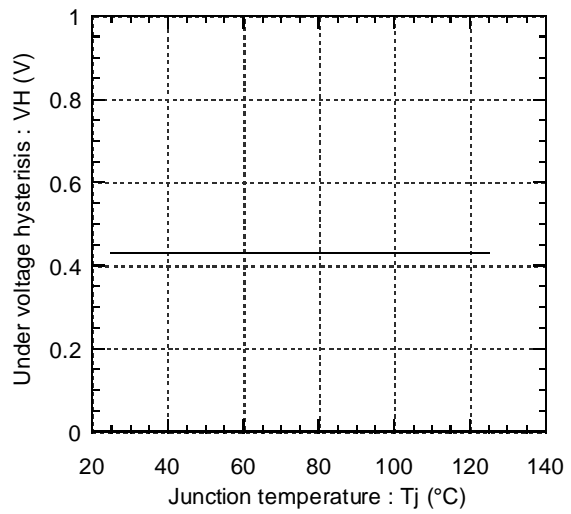

Alarm hold time vs. Power supply voltage (typ.)

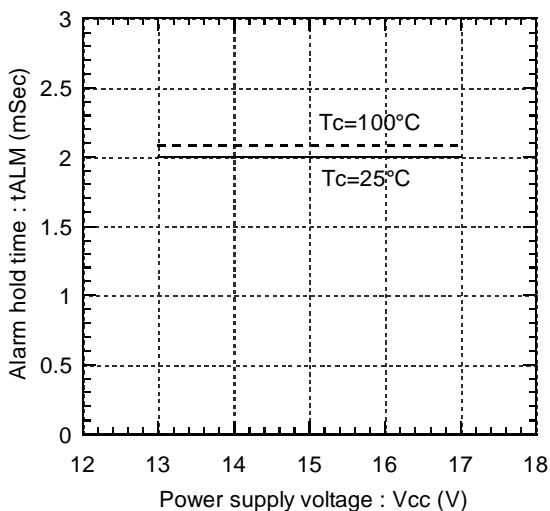

Over heating characteristics  
TjOH, TjH vs. Vcc (typ.)

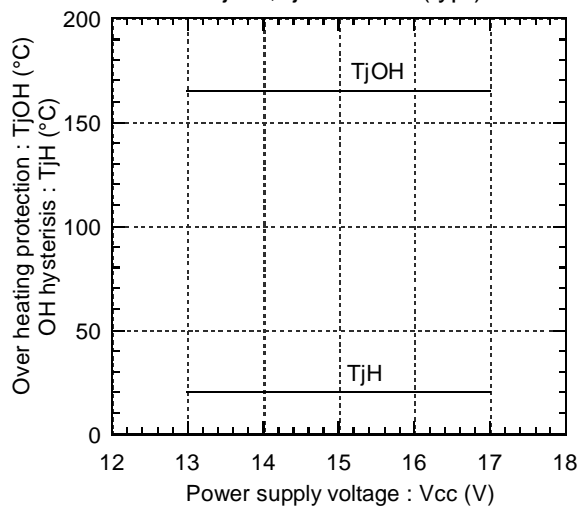

● Main circuit characteristics (Representative)

Collector current vs. Collector-Emitter voltage (typ.)  
T<sub>j</sub>=25°C / Chip

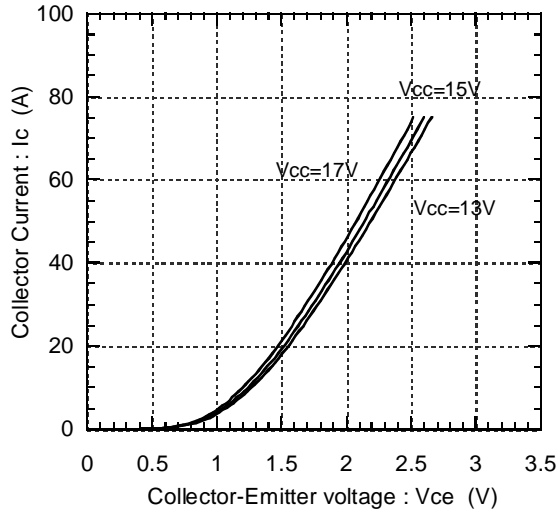

Collector current vs. Collector-Emitter voltage (typ.)  
T<sub>j</sub>=25°C / Terminal

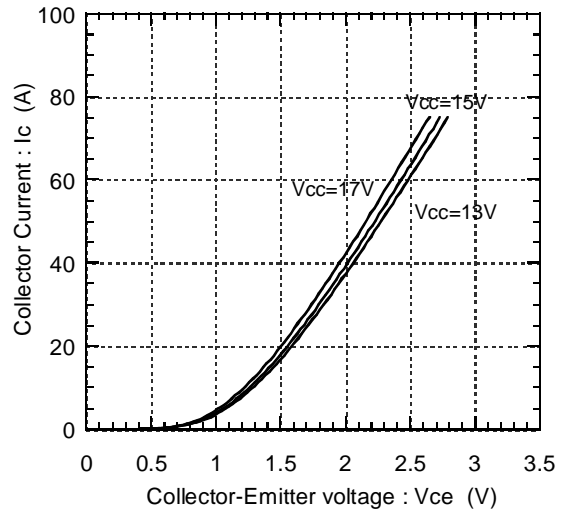

Collector current vs. Collector-Emitter voltage (typ.)  
T<sub>j</sub>=125°C / Chip

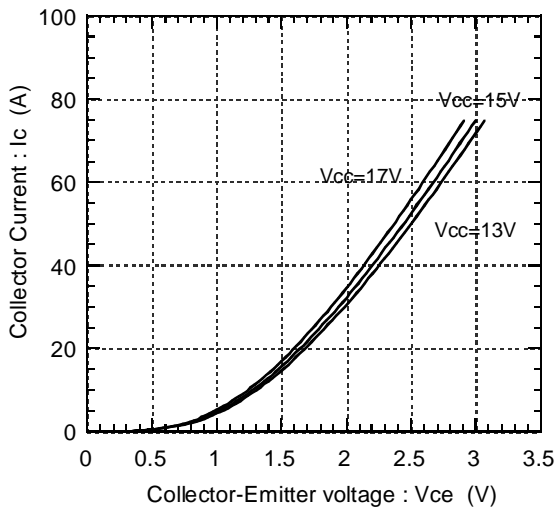

Collector current vs. Collector-Emitter voltage (typ.)  
T<sub>j</sub>=125°C / Terminal

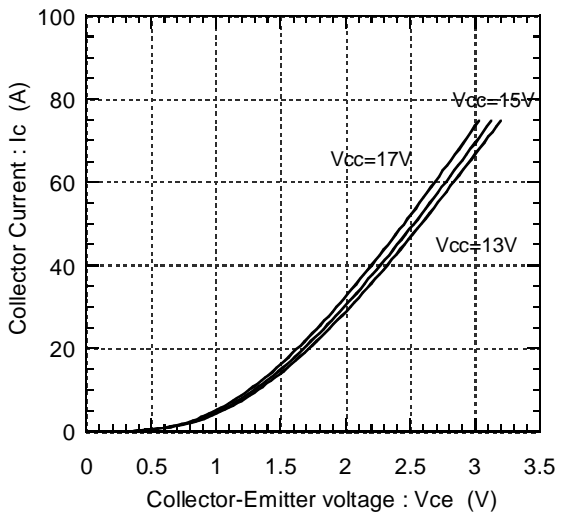

Forward current vs. Forward voltage (typ.)  
Chip

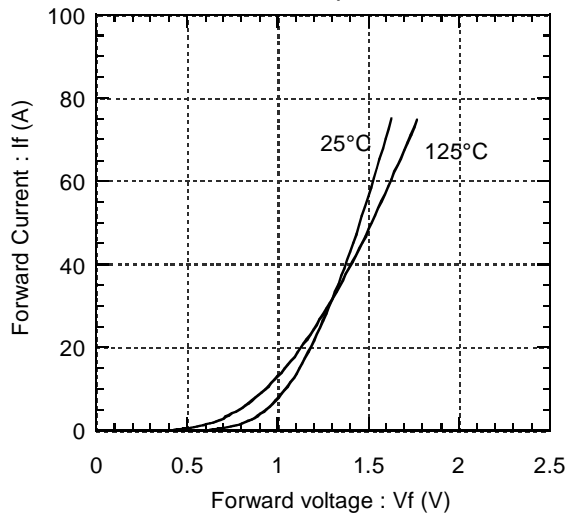

Forward current vs. Forward voltage (typ.)  
Terminal

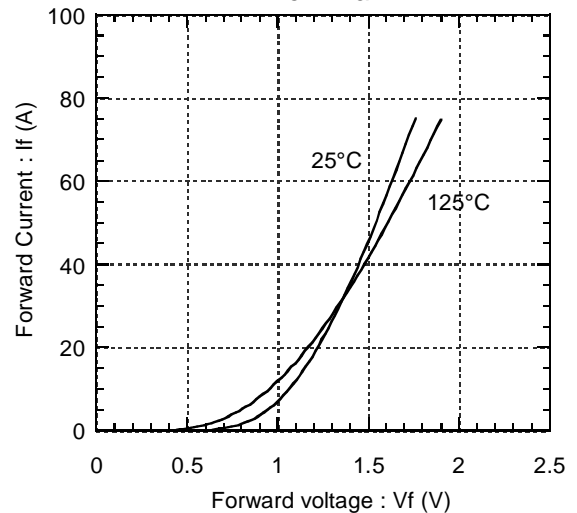

Switching Loss vs. Collector Current (typ.)  
 $E_{dc}=600V, V_{cc}=15V, T_j=25^\circ C$

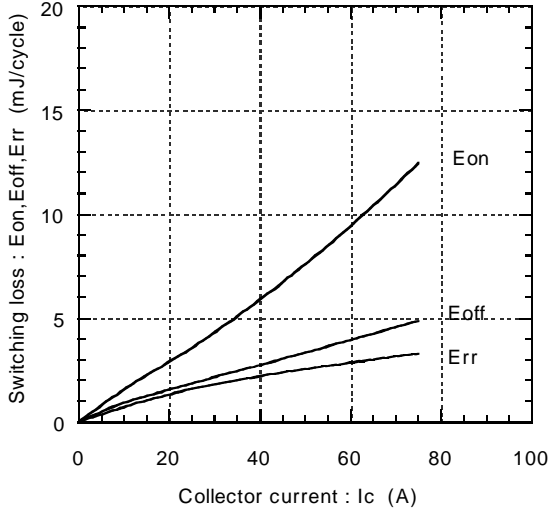

Switching Loss vs. Collector Current (typ.)  
 $E_{dc}=600V, V_{cc}=15V, T_j=125^\circ C$

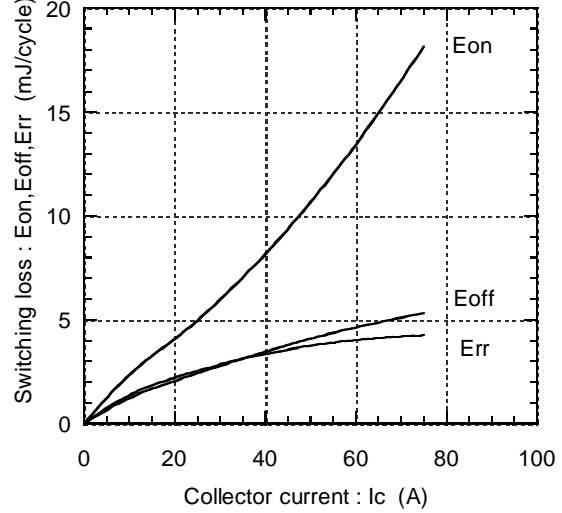

Reversed biased safe operating area  
 $V_{cc}=15V, T_j \le 125^\circ C$  (min.)

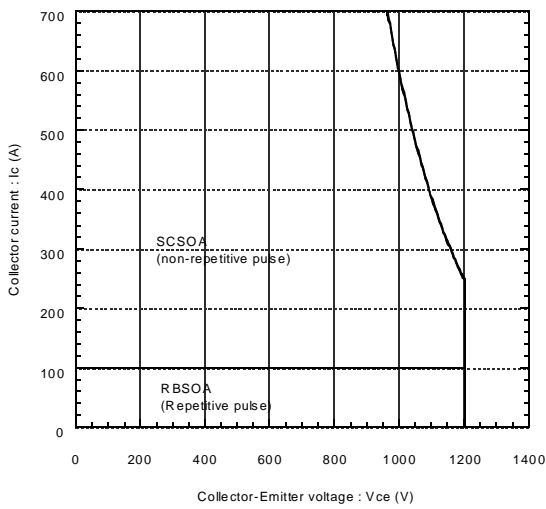

Transient thermal resistance (max.)

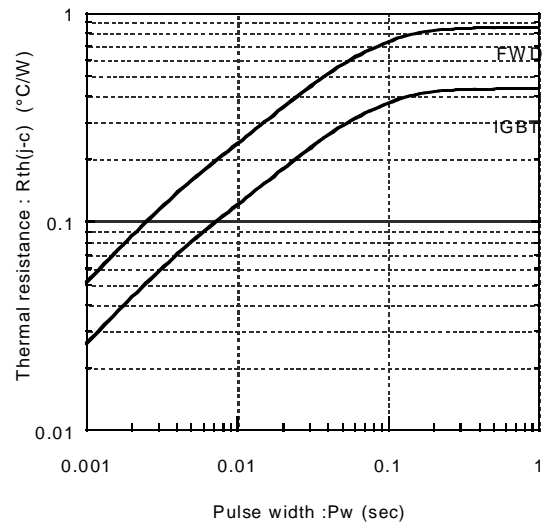

Power derating for IGBT (max.)  
 (per device)

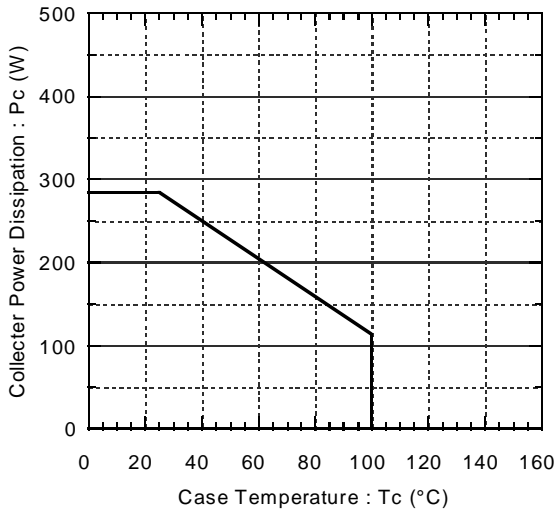

Power derating for FWD (max.)  
 (per device)

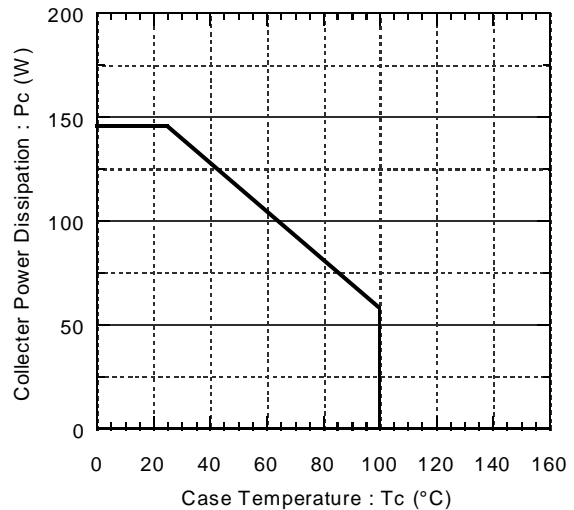

Switching time vs. Collector current (typ.)  
 $E_{dc}=600V, V_{cc}=15V, T_j=25^\circ C$

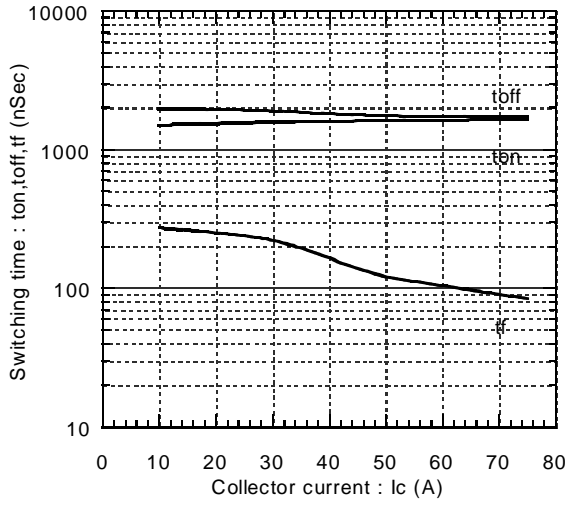

Switching time vs. Collector current (typ.)  
 $E_{dc}=600V, V_{cc}=15V, T_j=125^\circ C$

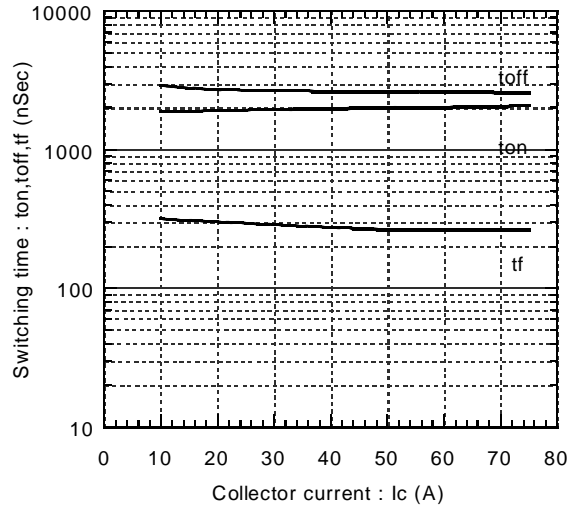

Reverse recovery characteristics  
 $t_{rr}, I_{rr}$  vs.  $I_F$  (typ.)

