

# 6N138

## High Sensitivity, High Speed OPIC Photocoupler

### ■ Features

1. High current transfer ratio  
(CTR : MIN. 300% at  $I_F = 1.6\text{mA}$ )
2. High speed response  
( $t_{PHL}$  : TYP.  $2\mu\text{s}$  at  $R_L = 2.2\text{k}\Omega$ )
3. Instantaneous common mode rejection  
voltage ( $CM_H$  : TYP.  $500\text{V}/\mu\text{s}$ )
4. TTL compatible output
5. Overseas standard model
6. Recognized by UL, file No. E64380.

### ■ Applications

1. Interfaces for computer peripherals
2. Electronic calculators, measuring instruments,  
control equipment
3. Telephone sets
4. Signal transmission between circuits of  
different potentials and impedances

### ■ Absolute Maximum Ratings

Parameter		Symbol	Rating	Unit
Input	Forward current	$I_F$	20	mA
	*1 Peak forward current	$I_F$	40	mA
	*2 Peak transient forward current	$I_{FM}$	1	A
	Reverse voltage	$V_R$	5	V
	Power dissipation	$P$	35	mW
Output	Supply voltage	$V_{CC}$	- 0.5 to + 7	V
	Output voltage	$V_O$	- 0.5 to + 7	V
	Emitter-base reverse withstand voltage (pin 5 to 7)	$V_{EBO}$	0.5	V
	*3 Average output current	$I_O$	60	mA
	Power dissipation	$P_O$	100	mW
	*4 Isolation voltage	$V_{iso}$	2 500	$V_{rms}$
	Operating temperature	$T_{opr}$	0 to + 70	$^{\circ}\text{C}$
	Storage temperature	$T_{stg}$	- 55 to + 125	$^{\circ}\text{C}$
*5 Soldering temperature	$T_{sol}$	260	$^{\circ}\text{C}$	

\*1 50% duty cycle, Pulse width: 1ms

\*2 pulse width  $\leq 1\mu\text{s}$ , 300pps

\*3 Decreases at the rate of  $0.7\text{mA}/^{\circ}\text{C}$  if the external temperature is  $25^{\circ}\text{C}$  or more.

\*4 40 to 60% RH, AC for 1 minute

\*5 For 10 seconds

### ■ Outline Dimensions

(Unit : mm)

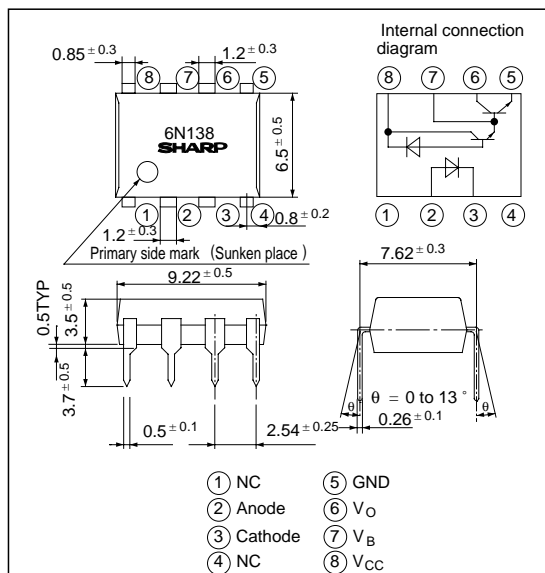

\* "OPIC" (Optical IC) is a trademark of the SHARP Corporation.  
An OPIC consists of a light-detecting element and signal-processing circuit integrated onto a single chip.

( $T_a = 25^{\circ}\text{C}$ )

## ■ Electro-optical Characteristics

( Ta = 0 to 70°C unless otherwise specified )

Parameter	Symbol	Conditions	MIN.	TYP.	MAX.	Unit
*1 Current transfer ratio	CTR	$I_F = 1.6\text{mA}$ , $V_O = 0.4\text{V}$ , $V_{CC} = 4.5\text{V}$	300	1 600	-	%
Logic (0) output voltage	$V_{OL}$	$I_O = 4.8\text{mA}$ , $V_{CC} = 4.5\text{V}$ , $I_F = 1.6\text{mA}$	-	0.1	0.4	V
Logic (1) output current	$I_{OH}$	$I_F = 0$ , $V_{CC} = V_O = 7\text{V}$	-	0.1	250	$\mu\text{A}$
Logic (0) supply current	$I_{CCL}$	$I_F = 1.6\text{mA}$ , $V_{CC} = 5\text{V}$ , $V_O = \text{open}$	-	0.5	-	mA
Logic (1) supply current	$I_{CCH}$	$I_F = 0$ , $V_{CC} = 5\text{V}$ , $V_O = \text{open}$	-	10	-	nA
Input forward voltage	$V_F$	$I_F = 1.6\text{mA}$ , $T_a = 25^\circ\text{C}$	-	1.5	1.7	V
Input forward voltage temperature coefficient	*2	$I_F = 1.6\text{mA}$	-	- 1.9	-	$\text{mV}/^\circ\text{C}$
Input reverse voltage	$BV_R$	$I_R = 10\mu\text{A}$ , $T_a = 25^\circ\text{C}$	5.0	-	-	V
Input capacitance	$C_{IN}$	$V_F = 0$ , $f = 1\text{MHz}$	-	60	-	pF
*3 Leak current (input-output )	$I_{LO}$	$T_a = 25^\circ\text{C}$ , 45% RH, $t = 5\text{s}$ $V_{LO} = 3\text{kV DC}$	-	-	1.0	$\mu\text{A}$
*3 Isolation resistance (input-output )	$R_{LO}$	$V_{LO} = 500\text{V DC}$	-	$10^{12}$	-	$\Omega$
*3 Capacitance (input-output )	$C_{LO}$	$f = 1\text{MHz}$	-	0.6	-	pF

\*1 Current transfer ratio is a ratio of input current and output current expressed in % .

\*2  $\Delta V_F / \Delta T_a$

\*3 Measured as 2-pin element (Short 1, 2, 3, 4 and 5, 6, 7, 8. )

Note ) Typical value : at  $T_a = 25^\circ\text{C}$ ,  $V_{CC} = 5\text{V}$

## ■ Switching Characteristics

(  $T_a = 25^\circ\text{C}$ ,  $V_{CC} = 5\text{V}$  )

Parameter	Symbol	Conditions	MIN.	TYP.	MAX.	Unit
*4 Propagation delay time Output (1) $\rightarrow$ (0)	$t_{PHL}$	$I_F = 1.6\text{mA}$ $R_L = 2.2\text{k}\Omega$	-	2	10	$\mu\text{s}$
*4 Propagation delay time Output (0) $\rightarrow$ (1)	$t_{PLH}$	$I_F = 1.6\text{mA}$ $R_L = 2.2\text{k}\Omega$	-	7	35	$\mu\text{s}$
*5 Instantaneous common mode rejection voltage " Output (1) "	$CM_H$	$I_F = 0$ , $V_{CM} = 10\text{V}_{P-P}$ $R_L = 2.2\text{k}\Omega$	-	500	-	$\text{V}/\mu\text{s}$
*5 Instantaneous common mode rejection voltage " Output (0) "	$CM_L$	$I_F = 1.6\text{mA}$ , $V_{CM} = 10\text{V}_{P-P}$ $R_L = 2.2\text{k}\Omega$	-	- 500	-	$\text{V}/\mu\text{s}$

\*5 Instantaneous common mode rejection voltage " output (1) " represents a common mode voltage variation that can hold the output above (1) level ( $V_O > 2.0\text{V}$ ).

Instantaneous common mode rejection voltage " output (0) " represents a common mode voltage variation that can hold the output above (0) level ( $V_O < 0.8\text{V}$ ).

### \*4 Test circuit for Propagation Delay Time

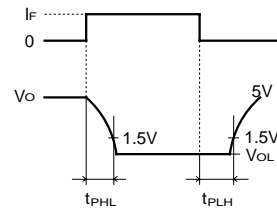
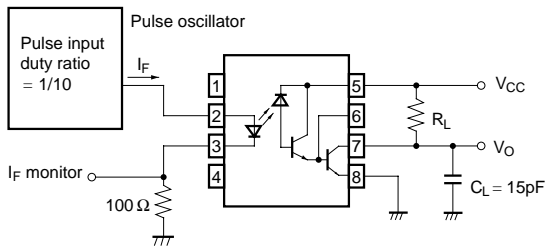

\*6 Test Circuit for Instantaneous Common Mode Rejection Voltage

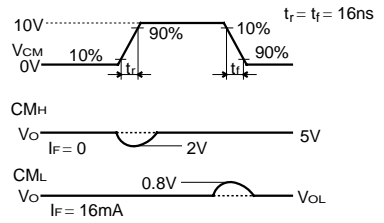
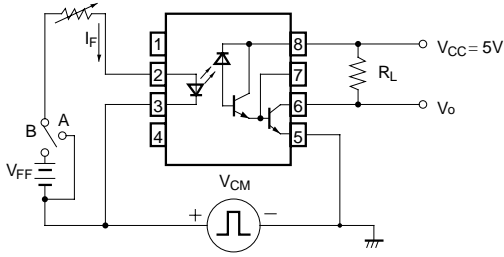

Fig. 1 Forward Current vs. Ambient Temperature

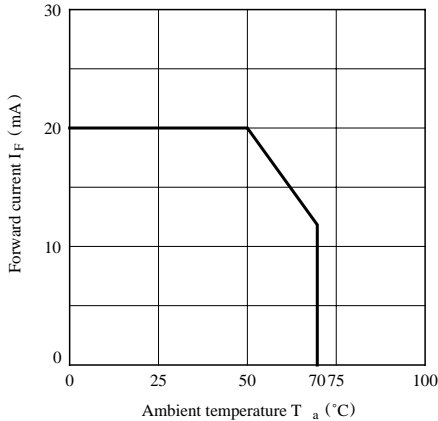

Fig. 2 Power Dissipation vs. Ambient Temperature

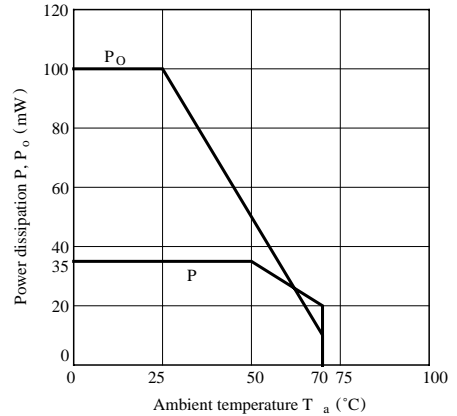

Fig. 3 Forward Current vs. Forward Voltage

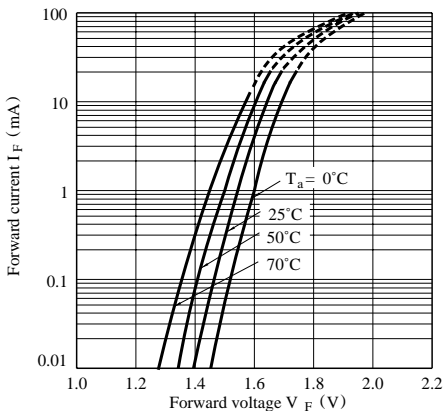
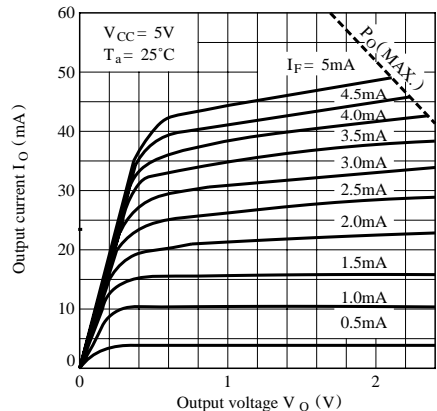
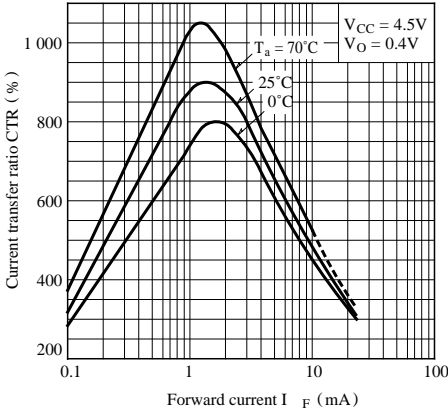

Fig. 4 Output Current vs. Output Voltage



**Fig. 5 Current Transfer Ratio vs. Forward Current**



**Fig. 6 Output Current vs. Forward Current**

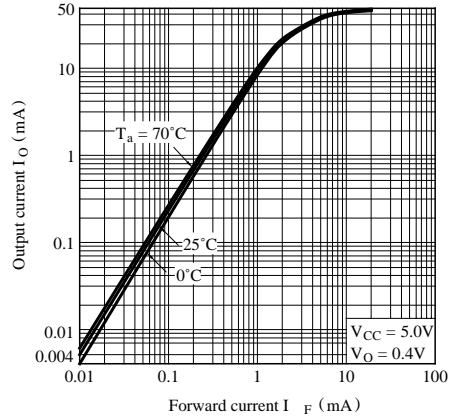

**Fig. 7-a Propagation Delay Time vs. Ambient Temperature**

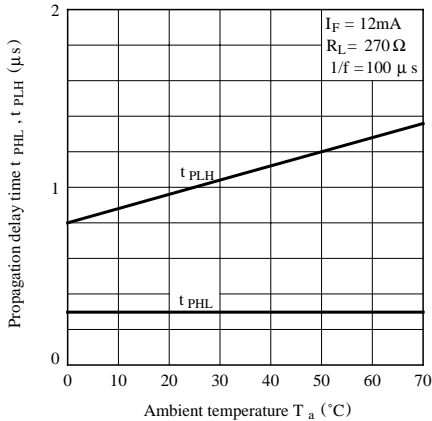

**Fig. 7-b Propagation Delay Time vs. Ambient Temperature**

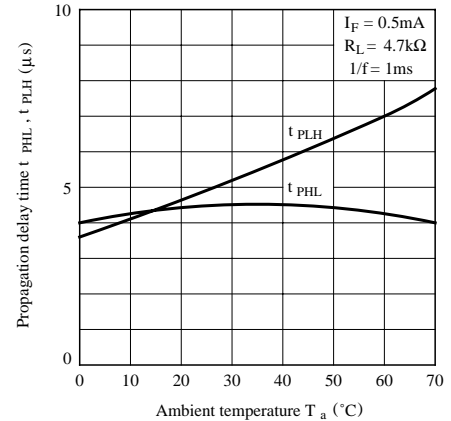

**Fig. 8 Rise Time, Fall Time vs. Load Resistance**

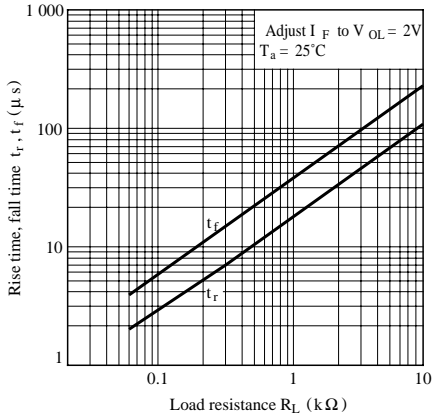

**Fig. 9 Logic (1) Supply Current vs. Ambient Temperature**

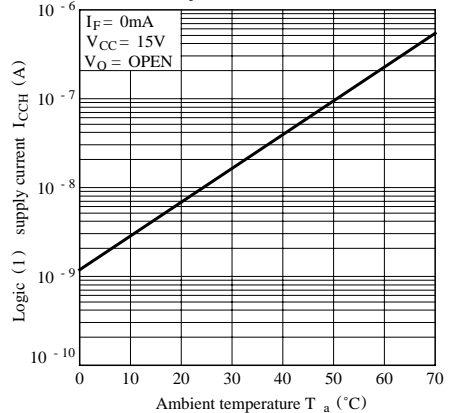

## \*7 Test Circuit for Rise Time, Fall Time vs. Load Resistance

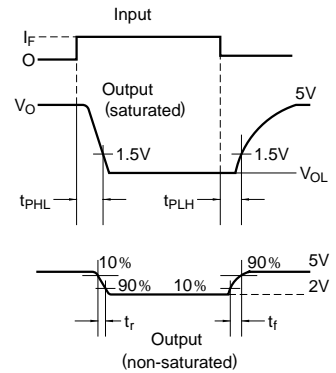
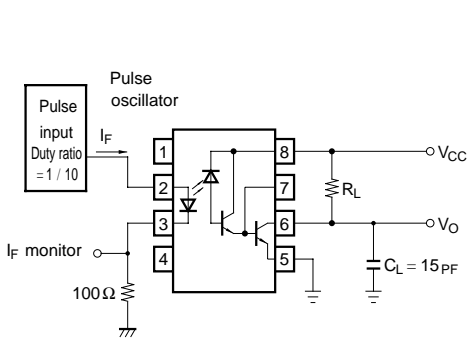

### ■ Precautions for Use

- (1) It is recommended that a by-pass capacitor of more than  $0.01\ \mu\text{ F}$  be added between  $V_{CC}$  and GND near the device in order to stabilize power supply line.
- (2) Transistor of detector side in bipolar configuration is apt to be affected by static electricity for its minute design. When handling them, general counterplan against static electricity should be taken to avoid breakdown of devices or degradation of characteristics.
- (3) As for other general cautions, refer to the chapter "Precautions for Use".