

## N-Channel Power MOSFET (6A, 800Volts)

### DESCRIPTION

The Nell **6N80** is a three-terminal silicon device with current conduction capability of 6A, fast switching speed, low on-state resistance, breakdown voltage rating of 800V, and max. threshold voltage of 5 volts.

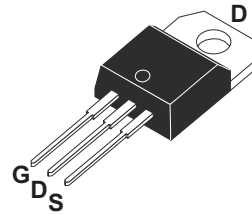
They are designed for use in applications, such as switched mode power supplies, DC to DC converters, **PWM** motor controls, bridge circuits, and general purpose switching applications.

### FEATURES

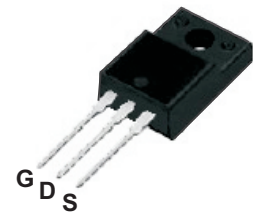
- $R_{DS(ON)} = 2.00\Omega @ V_{GS} = 10V$
- Ultra low gate charge(88nC max.)
- Low reverse transfer capacitance ( $C_{RSS} = 57pF$  typical)
- Fast switching capability
- 100% avalanche energy specified
- Improved dv/dt capability
- 150°C operation temperature

### PRODUCT SUMMARY

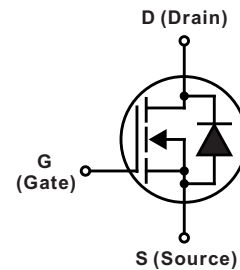
$I_D$ (A)	6
$V_{DSS}$ (V)	800
$R_{DS(ON)}$ ( $\Omega$ )	2.00 @ $V_{GS} = 10V$
$Q_G$ (nC) max.	88



TO-220AB  
(6N80A)



TO-220F  
(6N80AF)



### ABSOLUTE MAXIMUM RATINGS ( $T_C = 25^\circ C$ unless otherwise specified)

SYMBOL	PARAMETER	TEST CONDITIONS	VALUE	UNIT	
$V_{DSS}$	Drain to Source voltage	$T_J = 25^\circ C$ to $150^\circ C$	800	V	
$V_{DGR}$	Drain to Gate voltage	$R_{GS} = 20K\Omega$	800		
$V_{GS}$	Gate to Source voltage		$\pm 30$		
$I_D$	Continuous Drain Current	$T_C = 25^\circ C$	6	A	
		$T_C = 100^\circ C$	3.8		
$I_{DM}$	Pulsed Drain current(Note 1)		24		
$I_{AR}$	Avalanche current(Note 1)		6		
$E_{AR}$	Repetitive avalanche energy(Note 1)	$I_{AR} = 6A, R_{GS} = 50\Omega, V_{GS} = 10V$	16	mJ	
$E_{AS}$	Single pulse avalanche energy(Note 2)	$I_{AS} = 6A, L = 25mH$	480		
dv/dt	Peak diode recovery dv/dt(Note 3)		2.0	V/ns	
$P_D$	Total power dissipation (Derate above $25^\circ C$ )	$T_C = 25^\circ C$	TO-220AB	160 (1.28)	W(W/ $^\circ C$ )
			TO-220F	51 (0.41)	
$T_J$	Operation junction temperature		-55 to 150	$^\circ C$	
$T_{STG}$	Storage temperature		-55 to 150		
$T_L$	Maximum soldering temperature, for 10 seconds	1.6mm from case	300		
	Mounting torque, #6-32 or M3 screw		10 (1.1)	lbf-in (N-m)	

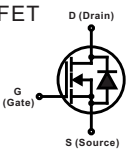
Note: 1. Repetitive rating: pulse width limited by junction temperature..

2.  $I_{AS} = 6A, V_{DD} = 50V, L = 25mH, R_{GS} = 27\Omega$ , starting  $T_J = 25^\circ C$ .

3.  $I_{SD} \leq 7A, di/dt \leq 150A/\mu s, V_{DD} \leq V_{(BR)DSS}$ , starting  $T_J = 25^\circ C$ .

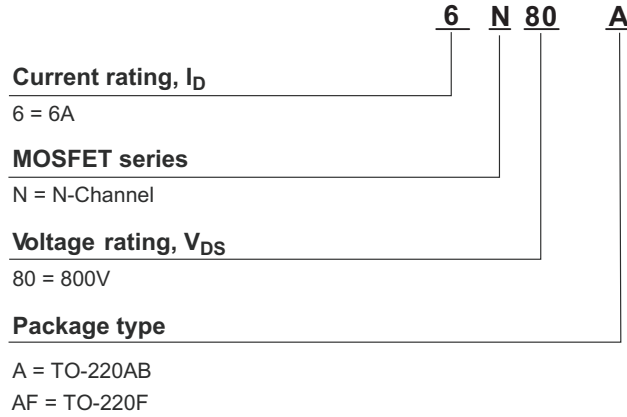
THERMAL RESISTANCE						
SYMBOL	PARAMETER		Min.	Typ.	Max.	UNIT
$R_{th(j-c)}$	Thermal resistance, junction to case	TO-220AB			0.78	°C/W
		TO-220F			2.45	
$R_{th(j-a)}$	Thermal resistance, junction to ambient	TO-220AB/TO-220F			62.5	

ELECTRICAL CHARACTERISTICS ( $T_C = 25^\circ\text{C}$ unless otherwise specified)						
SYMBOL	PARAMETER	TEST CONDITIONS	Min.	Typ.	Max.	UNIT
<b>OFF CHARACTERISTICS</b>						
$V_{(BR)DSS}$	Drain to source breakdown voltage	$I_D = 250\mu\text{A}, V_{GS} = 0\text{V}$	800			V
$\Delta V_{(BR)DSS}/\Delta T_J$	Breakdown voltage temperature coefficient	$I_D = 250\mu\text{A}, V_{DS} = V_{GS}$		0.93		V/°C
$I_{DSS}$	Drain to source leakage current	$V_{DS} = 800\text{V}, V_{GS} = 0\text{V}$ $T_C = 25^\circ\text{C}$			10	$\mu\text{A}$
		$V_{DS} = 640\text{V}, V_{GS} = 0\text{V}$ $T_C = 125^\circ\text{C}$			100	
$I_{GSS}$	Gate to source forward leakage current	$V_{GS} = 30\text{V}, V_{DS} = 0\text{V}$			100	nA
	Gate to source reverse leakage current	$V_{GS} = -30\text{V}, V_{DS} = 0\text{V}$			-100	
<b>ON CHARACTERISTICS</b>						
$R_{DS(ON)}$	Static drain to source on-state resistance	$I_D = 3\text{A}, V_{GS} = 10\text{V}$		1.6	2.0	$\Omega$
$V_{GS(TH)}$	Gate threshold voltage	$V_{GS} = V_{DS}, I_D = 250\mu\text{A}$	3		5	V
$g_{fs}$	Forward transconductance (Note 1)	$V_{DS} = 50\text{V}, I_D = 3\text{A}$		5.4		S
<b>DYNAMIC CHARACTERISTICS</b>						
$C_{ISS}$	Input capacitance	$V_{DS} = 25\text{V}, V_{GS} = 0\text{V}, f = 1\text{MHz}$		1500	1950	pF
$C_{OSS}$	Output capacitance		140	165		
$C_{RSS}$	Reverse transfer capacitance		57	66		
<b>SWITCHING CHARACTERISTICS</b>						
$t_{d(ON)}$	Turn-on delay time	$V_{DD} = 400\text{V}, V_{GS} = 10\text{V}, I_D = 6\text{A}, R_{GS} = 25\Omega$ (Note 1, 2)		26	60	ns
$t_r$	Rise time		65	140		
$t_{d(OFF)}$	Turn-off delay time		47	105		
$t_f$	Fall time		44	90		
$Q_G$	Total gate charge	$V_{DD} = 640\text{V}, V_{GS} = 10\text{V}, I_D = 7\text{A}$ (Note 1, 2)		67	88	nC
$Q_{GS}$	Gate to source charge		11			
$Q_{GD}$	Gate to drain charge (Miller charge)		30			

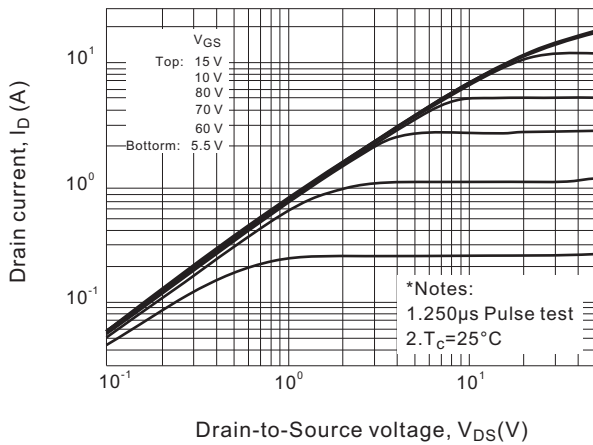
SOURCE TO DRAIN DIODE RATINGS AND CHARACTERISTICS ( $T_C = 25^\circ\text{C}$ unless otherwise specified)						
SYMBOL	PARAMETER	TEST CONDITIONS	Min.	Typ.	Max.	UNIT
$V_{SD}$	Diode forward voltage	$I_{SD} = 6\text{A}, V_{GS} = 0\text{V}$			1.4	V
$I_S$ ( $I_{SD}$ )	Continuous source to drain current	Integral reverse P-N junction diode in the MOSFET 			6	A
$I_{SM}$	Pulsed source current		24			
$t_{rr}$	Reverse recovery time	$I_{SD} = 7\text{A}, V_{GS} = 0\text{V}, dI_F/dt = 100\text{A}/\mu\text{s}$		520		ns
$Q_{rr}$	Reverse recovery charge			6.7		$\mu\text{C}$

Note: 1. Pulse test: Pulse width  $\leq 250\mu\text{s}$ , duty cycle  $\leq 2\%$ .  
 2. Essentially independent of operating temperature.

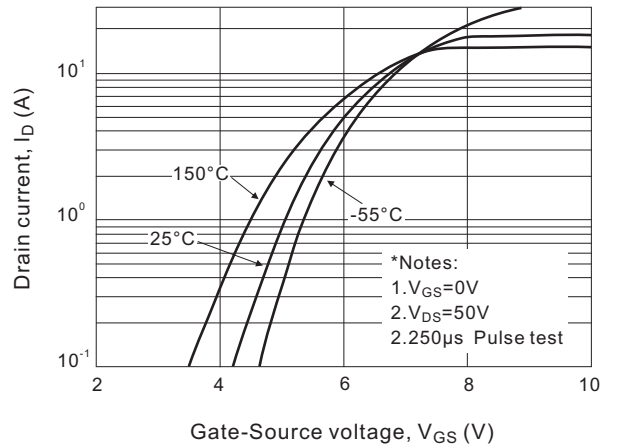
**ORDERING INFORMATION SCHEME**



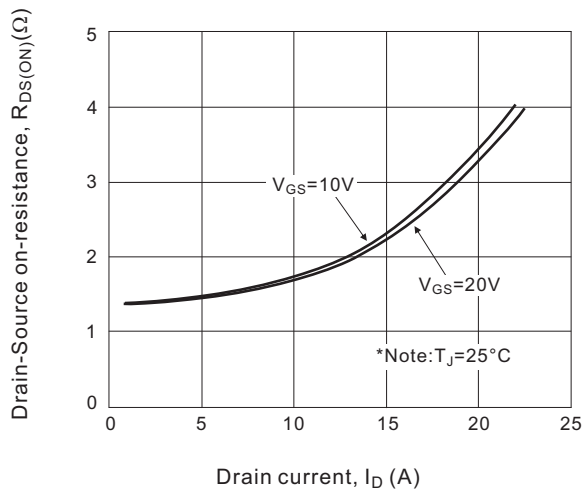
**Fig.1 Output characteristics**



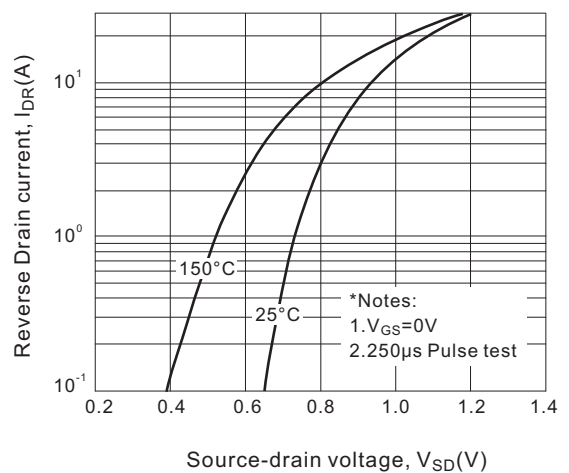
**Fig.2 Transfer characteristics**



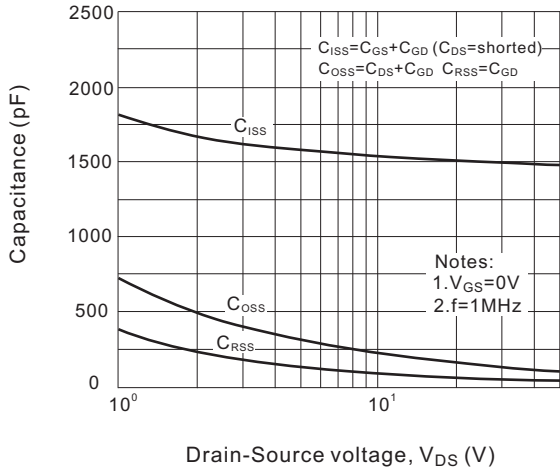
**Fig.3 On-resistance variation vs. drain current**



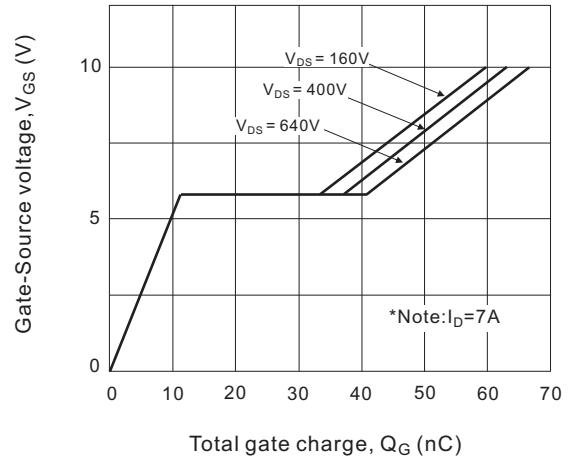
**Fig.4 Source-drain diode forward voltage**



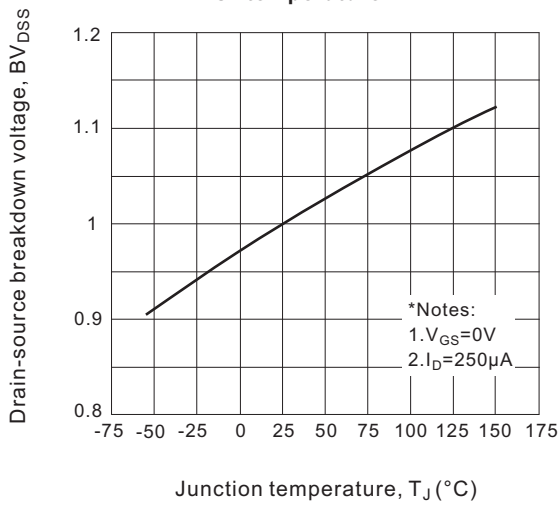
**Fig.5 Capacitance vs. drain-source voltage**



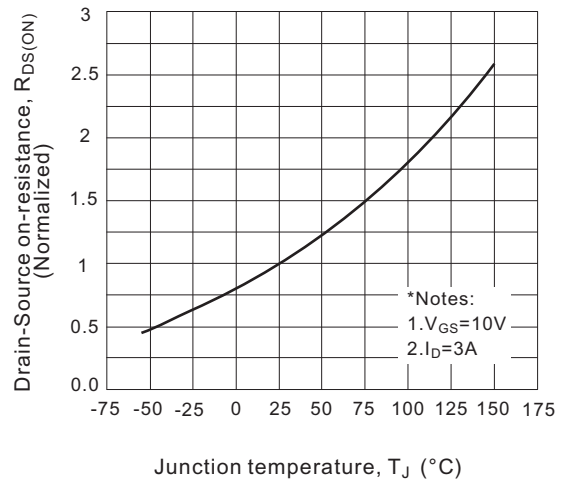
**Fig.6 Gate charge vs. gate-source voltage**



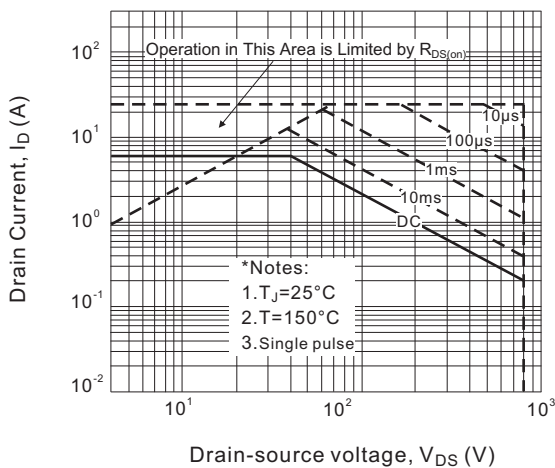
**Fig.7 Breakdown voltage variation vs. temperature**



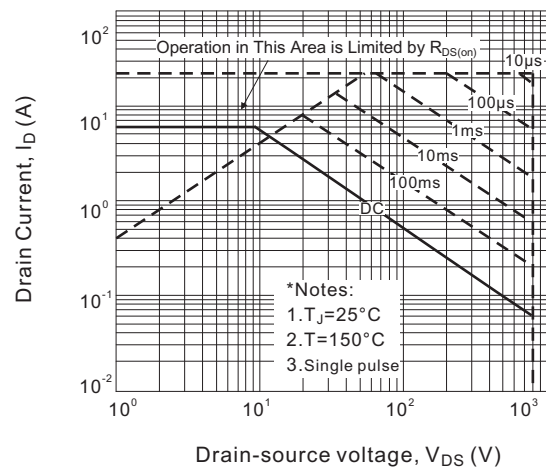
**Fig.8 On-resistance vs. temperature**



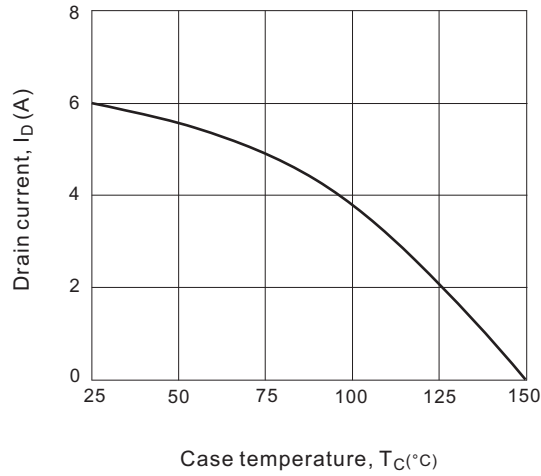
**Fig.9-1 Maximum safe operating area for 6N80A**



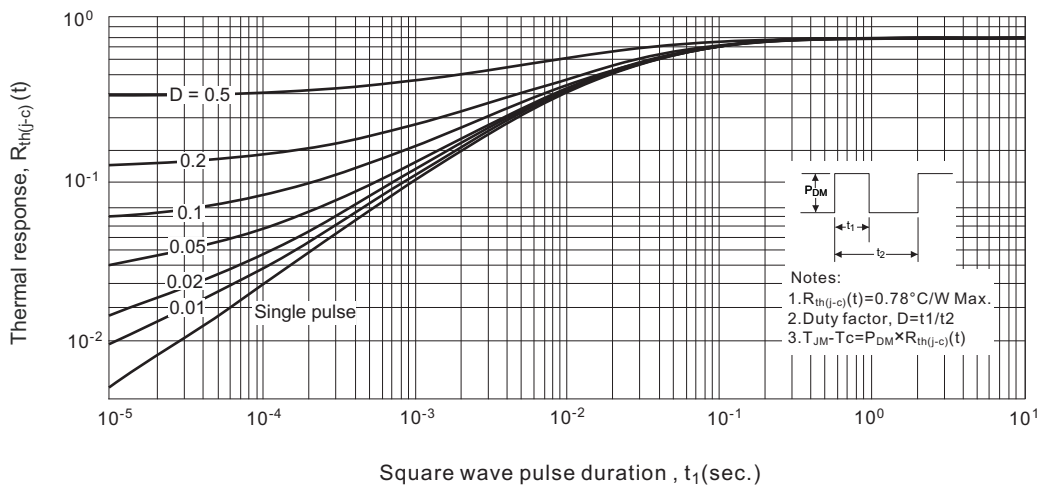
**Fig.9-2 Transient thermal response curve for 6N80AF**



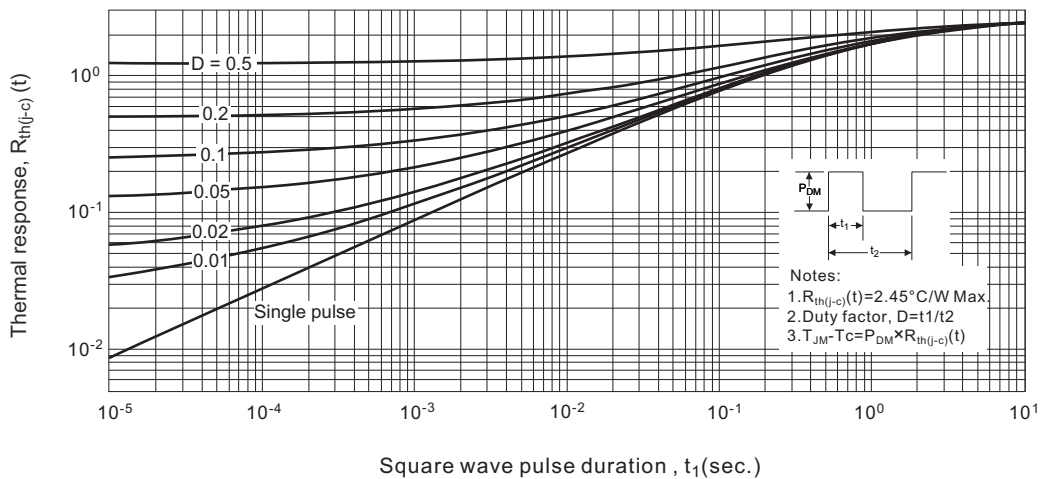
**Fig.10 Maximum drain current vs. case temperature**



**Fig.11-1 Transient Thermal Response Curve for 6N80A**

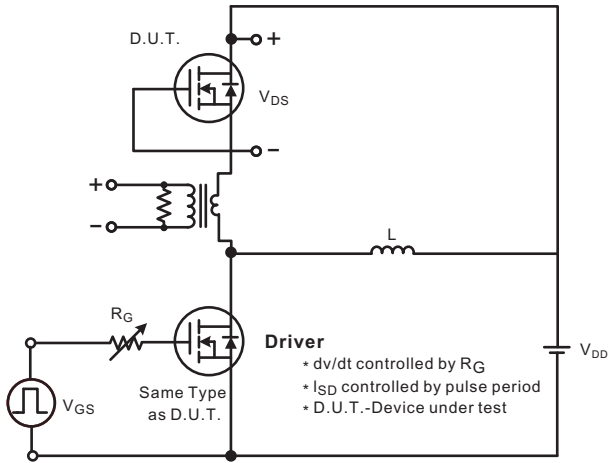


**Fig.11-2 Transient Thermal Response Curve for 6N80AF**

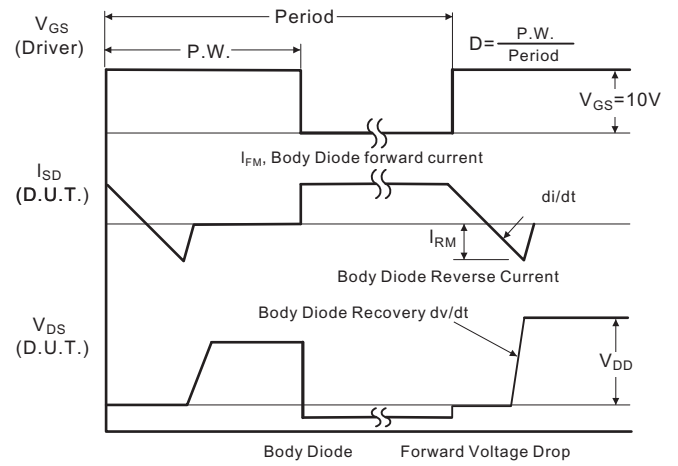


### ■ TEST CIRCUITS AND WAVEFORMS

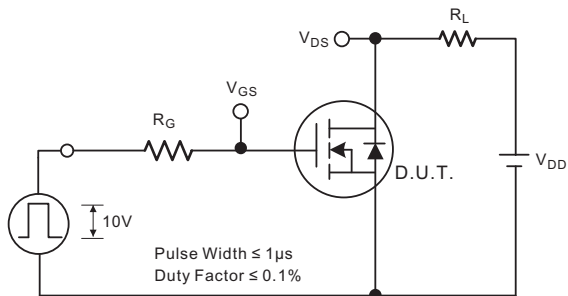
**Fig.1A Peak diode recovery dv/dt test circuit**



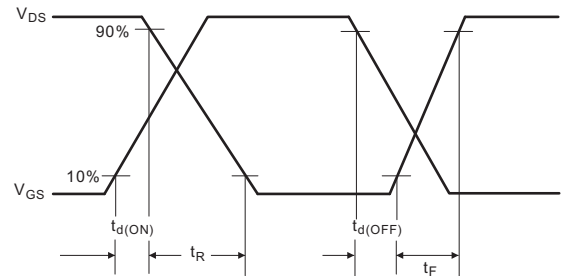
**Fig.1B Peak diode recovery dv/dt waveforms**



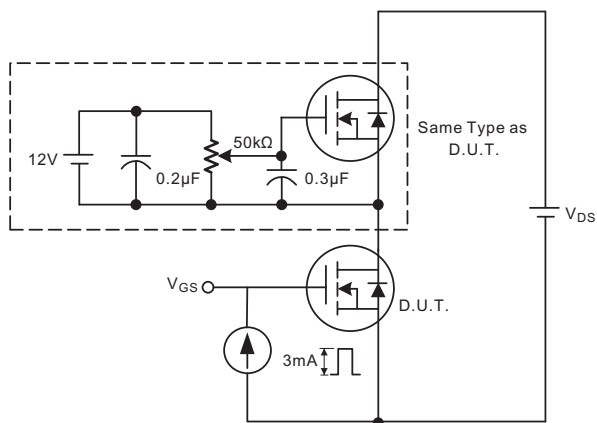
**Fig.2A Switching test circuit**



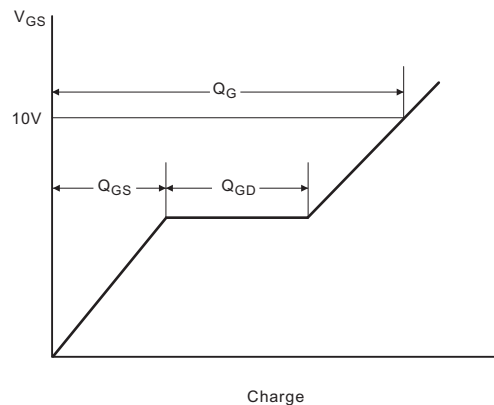
**Fig.2B Switching Waveforms**



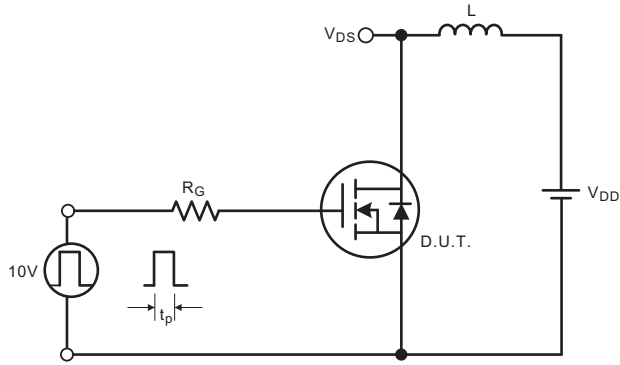
**Fig.3A Gate charge test circuit**



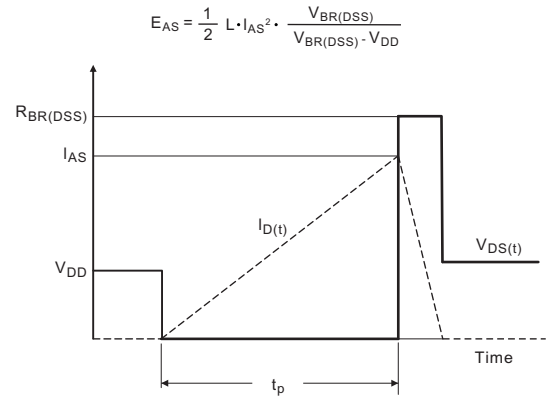
**Fig.3B Gate charge waveform**



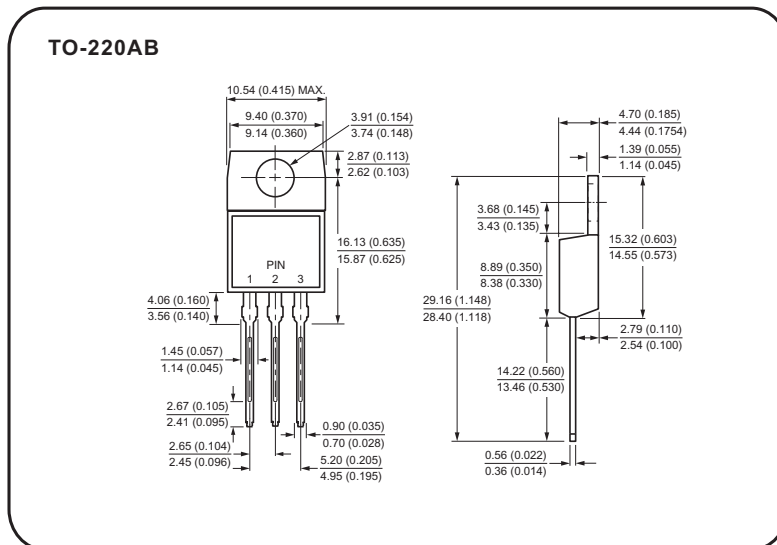
**Fig.4A Unclamped Inductive switching test circuit**



**Fig.4B Unclamped Inductive switching waveforms**



### Case Style



**Case Style**

