

Fast Recovery Diodes (Stud Version), 70A



FEATURES

- Short reverse recovery time
- Low stored charge
- Wide current range
- Excellent surge capabilities
- Stud cathode and stud anode versions
- Voltage up to 1200 V_{RRM}
- Compliant to RoHS

TYPICAL APPLICATIONS

- DC power supplies
- Inverters
- Converters
- Choppers
- Ultrasonic systems
- Freewheeling diodes



DO-203AB(DO-5)

PRODUCT SUMMARY

I _{F(AV)}	70A
--------------------	-----

MAJOR RATINGS AND CHARACTERISTICS

SYMBOL	CHARACTERISTICS	70FD(R)	UNIT
I _{F(AV)}		70	A
	Maximum T _C	85	°C
I _{FSM}	50 HZ	830	A
	60 HZ	870	
I ² t	50 HZ	3445	A ² s
	60 HZ	3141	
I ² √t		34445	I ² √s
V _{RRM}	Range	200 to 1200	V
t _{rr}		See Recovery Characteristics table	ns
T _J	Range	-40 to 125	°C

ELECTRICAL SPECIFICATIONS

VOLTAGE RATINGS

TYPE NUMBER	VOLTAGE CODE	V _{RRM} , MAXIMUM PEAK REPETITIVE REVERSE VOLTAGE T _J = -40°C TO 125°C V	V _{RSM} , MAXIMUM PEAK NON-REPETITIVE REVERSE VOLTAGE T _J = 25°C TO 125°C V	I _{FM} , MAXIMUM PEAK REVERSE CURRENT AT RATED V _{RRM} mA	
				T _J = 25°C	T _J = 125°C
70FD(R)	02	200	300	0.1	15
	04	400	500		
	06	600	700		
	08	800	900		
	10	1000	1100		
	12	1200	1300		

FORWARD CONDUCTION					
PARAMETER	SYMBOL	TEST CONDITIONS		70FD(R)	UNIT
Maximum average forward current at maximum case temperature	$I_{F(AV)}$	180° conduction, half sine wave		70	A
				85	°C
Maximum RMS forward current	$I_{F(RMS)}$			110	A
Maximum peak repetitive forward current	I_{FRM}	Sinusoidal half wave, 30° conduction		380	A
Maximum peak, one-cycle non-repetitive surge current	I_{FSM}	t = 10ms	Sinusoidal half wave, 100% V_{RRM} reapplied, initial $T_J = T_J$ maximum	700	A
		t = 8.3ms		730	
		t = 10ms	Sinusoidal half wave, no voltage reapplied, initial $T_J = T_J$ maximum	830	
		t = 8.3ms		870	
Maximum I^2t for fusing	I^2t	t = 10ms	100% V_{RRM} reapplied, initial $T_J = T_J$ maximum	2450	A ² s
		t = 8.3ms		2212	
		t = 10ms	no voltage reapplied, initial $T_J = T_J$ maximum	3445	
		t = 8.3ms		3141	
Maximum $I^2\sqrt{t}$ for fusing ⁽¹⁾	$I^2\sqrt{t}$	t = 0.1 ms to 10 ms, no voltage reapplied		34445	A ² √s
Maximum value of threshold voltage	$V_{F(TO)}$	$T_J = 125^\circ\text{C}$		1.085	V
Maximum value of forward slope resistance	r_F			3.40	mΩ
Maximum forward voltage drop	V_{FM}	$T_J = 25^\circ\text{C}; I_{FM} = 220\text{A}$		1.85	V

Note : ⁽¹⁾ I^2t for time $t_x = I^2\sqrt{t} \sqrt{t_x}$

SWITCHING					
PARAMETER	SYMBOL	TEST CONDITIONS	70FD(R)		UNIT
			02 to 06	08 to 12	
Typical reverse recovery time	t_{rr}	$T_J = 25^\circ\text{C}, I_F = 0.5\text{A}, I_R = 1.0\text{A}, I_{RR} = 250\text{mA (RG\#1 CKT)}$	200	500	ns
		$T_J = 25^\circ\text{C}, I_F = 1\text{A to } V_R = 30\text{V}, -di_F/dt = 100\text{ A}/\mu\text{s}$	60	150	
		$T_J = 25^\circ\text{C}, -di_F/dt = 25\text{ A}/\mu\text{s}, I_{FM} = \pi \times \text{rated } I_{F(AV)}$	200	500	
Typical reverse recovered charge	Q_{rr}	$T_J = 25^\circ\text{C}, I_F = 1\text{A to } V_R = 30\text{V}, -di_F/dt = 100\text{ A}/\mu\text{s}$	90	500	nC
		$T_J = 25^\circ\text{C}, -di_F/dt = 25\text{ A}/\mu\text{s}, I_{FM} = \pi \times \text{rated } I_{F(AV)}$	240	1300	

THERMAL AND MECHANICAL SPECIFICATIONS				
PARAMETER	SYMBOL	TEST CONDITIONS	70FD(R)	UNITS
Maximum junction operating temperature range	T_J		-40 to 125	°C
Maximum storage temperature range	T_{stg}		-40 to 150	
Maximum thermal resistance, junction to case	R_{thJC}	DC operation	0.36	K/W
Maximum thermal resistance, case to heatsink	R_{thCS}	Mounting surface, smooth, flat and greased	0.25	
Maximum allowable mounting torque (+0%, -10%)		Not lubricated threads, tightening on nut ⁽¹⁾	3.4(30)	N · m (lbf · in)
		Lubricated thread, tightening on nut ⁽¹⁾	2.3(20)	
		Not lubricated threads, tightening on hexagon ⁽²⁾	4.2(37)	
		Lubricated thread, tightening on hexagon ⁽²⁾	3.2(28)	
Approximate weight			25	g
			0.88	oz.
Case style		JEDEC	DO-203AB (DO-5)	

Note : (1) Recommended for pass-through holes
 (2) Recommended for holed threaded heatsinks

△ R_{thJC} CONDUCTION				
CONDUCTION ANGLE	70FD(R)		TEST CONDUCTIONS	UNITS
	SINUSOIDAL CONDUCTION	RECTANGULAR CONDUCTION		
180°	0.29	0.15	$T_J = 150^\circ\text{C}$	K/W
120°	0.31	0.29		
60°	0.65	0.65		
30°	1.11	1.10		

Note
 • The table above shows the increment of thermal resistance R_{thJC} when devices operate at different conduction angles than DC

ORDERING INFORMATION SCHEME	
<p>70 FD R 06 A</p>	<p>Current 70 = 70A</p> <p>Diode type FD = Fast Recovery Diode</p> <p>Polarity R = Reverse, Anode on Stud None = standard, Cathode on Stud</p> <p>Voltage 06 = 600V 08 = 800V 10 = 1000V 12 = 1200V</p> <p>Trr value A = 200 ns Max. B = 500 ns Max.</p>

Fig.1 Current rating nomogram (Sinusoidal Waveforms)

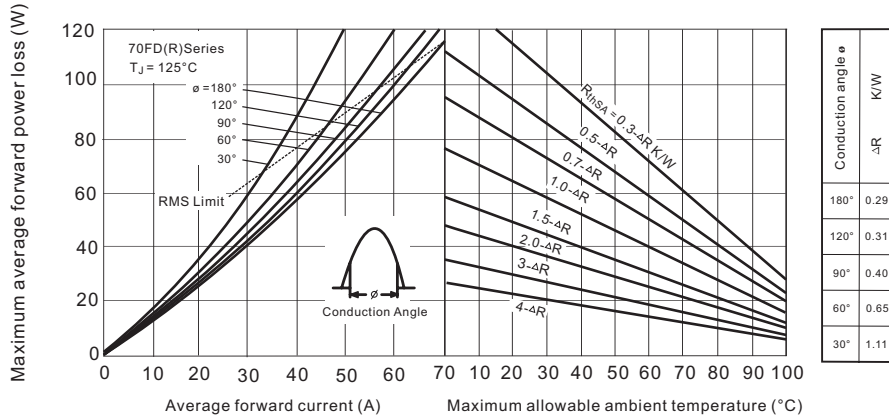

Fig.2 Current rating nomogram (Rectangular waveforms)

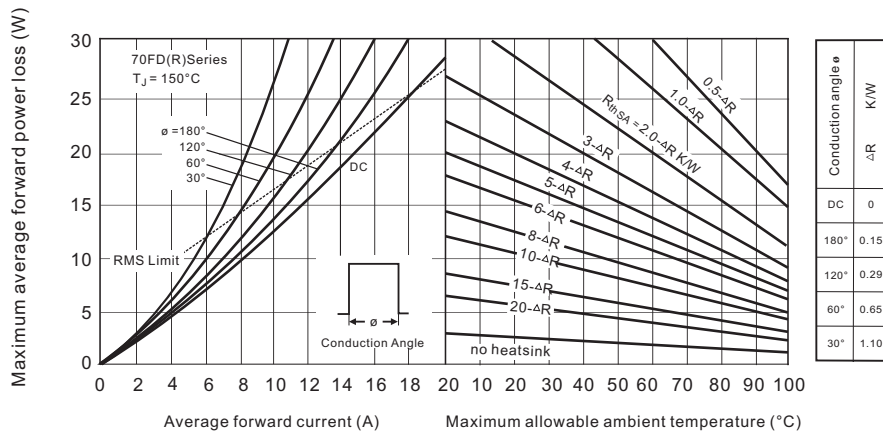

Fig.3 Maximum high level forward power loss vs. average forward current

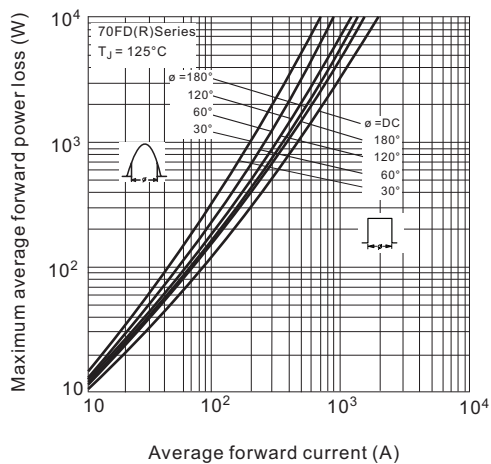

Fig.4 Maximum forward voltage vs. forward current.

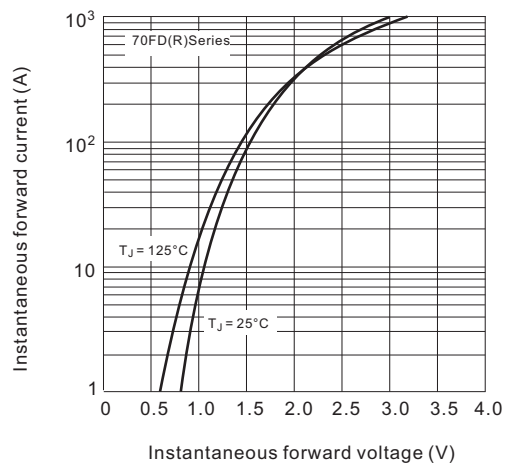

Fig.5 Average forward current vs. maximum allowable case temperature.

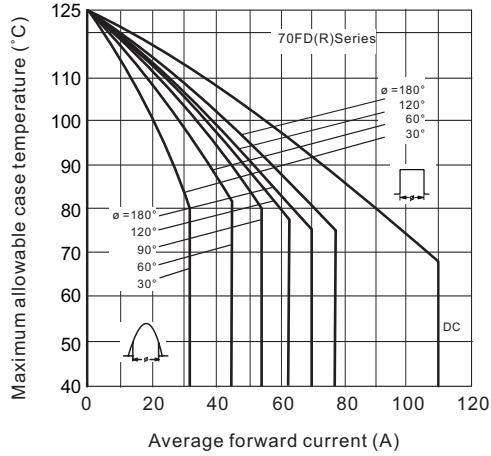

Fig.6 Typical reverse recovery time vs. rate of fall of forward current.

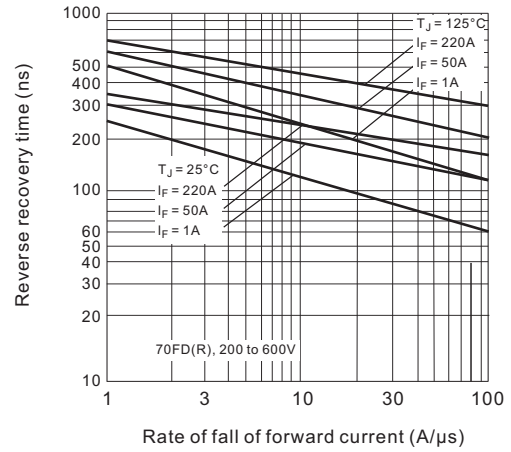

Fig.7 Typical recovered charge vs. rate of fall of forward current.

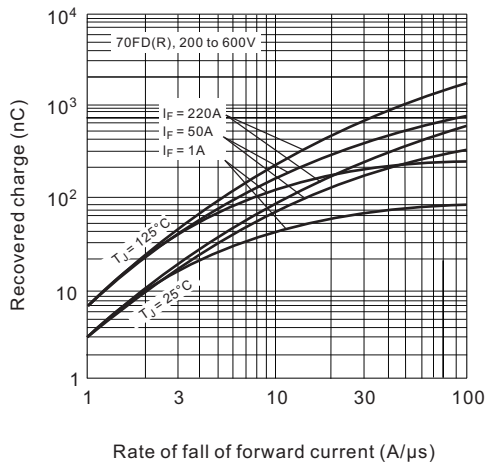

Fig.8 Typical reverse recovery time vs. rate of fall of forward current.

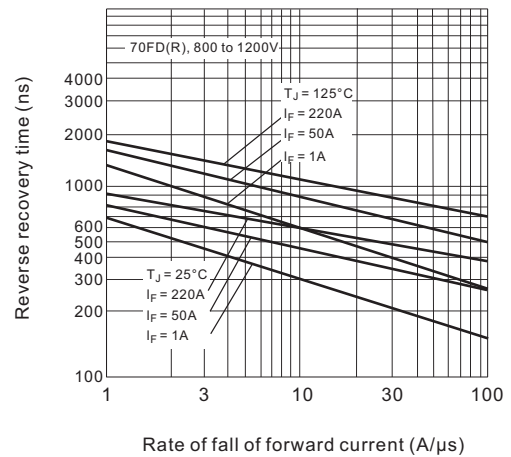
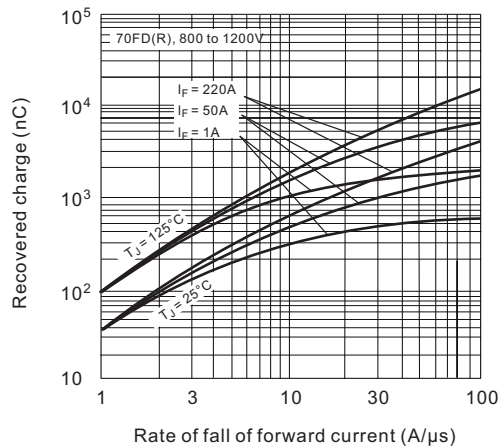
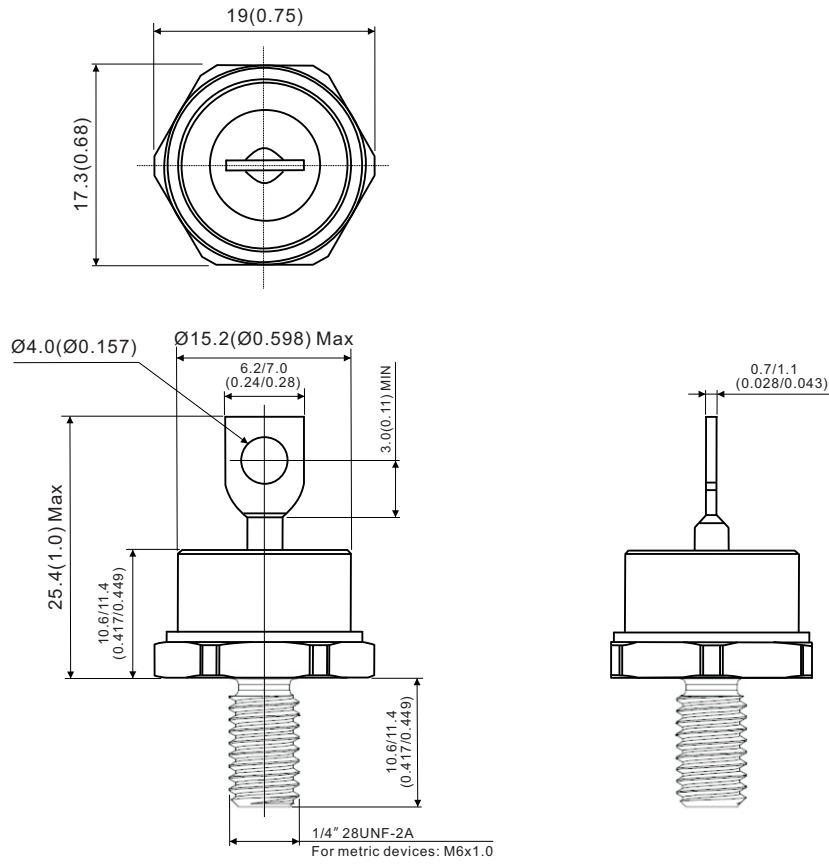

Fig.9 Typical recovered charge vs. rate of fall of forward current.



DO-203AB(DO-5)



All dimensions in millimeters (inches)

