

Document No.	853-1010
ECN No.	96898
Date of Issue	May 11, 1990
Status	Product Specification
ACL Products	

# AC11239: Product Specification

## ACT11239: Preliminary Specification

### Dual 2-to-4 line decoder/demultiplexer, active-High

#### FEATURES

- Demultiplexing capability
- Two independent 1-of-4 decoders
- Non-inverting outputs
- Output capability:  $\pm 24$  mA
- CMOS (AC) and TTL (ACT) voltage level inputs
- 50 $\Omega$  incident wave switching
- Center-pin  $V_{CC}$  and ground configuration to minimize high-speed switching noise
- $I_{CC}$  category: MSI

#### DESCRIPTION

The 74AC/ACT11239 high-performance CMOS devices combine very high speed and high output drive comparable to the most advanced TTL families.

The 74AC/ACT11239 has two independent decoders, each accepting two binary weighted inputs ( $nA_0, nA_1$ ) and providing four mutually exclusive active-High outputs ( $nY_0 - nY_3$ ). Each decoder has an active-Low Enable ( $n\bar{E}$ ). When  $\bar{E}$  is High, every output is forced Low. The Enable can be used as the Data input for a 1-of-4 demultiplexer application.

#### QUICK REFERENCE DATA

SYMBOL	PARAMETER	CONDITIONS $T_{amb} = 25^\circ\text{C}; \text{GND} = 0\text{V};$ $V_{CC} = 5.0\text{V}$	TYPICAL		UNIT
			AC	ACT	
$t_{PLH}/t_{PHL}$	Propagation delay $nA_n$ to $nY_n$	$C_L = 50\text{pF}$	3.9	5.2	ns
$C_{PD}$	Power dissipation capacitance per decoder <sup>1</sup>	$f = 1\text{MHz}; C_L = 50\text{pF}$	48	50	pF
$C_{IN}$	Input capacitance	$V_I = 0\text{V}$ or $V_{CC}$	3.5	3.5	pF
$I_{LATCH}$	Latch-up current	Per Jeduc JC40.2 Standard 17	500	500	mA

#### Note:

1.  $C_{PD}$  is used to determine the dynamic power dissipation ( $P_D$  in  $\mu\text{W}$ ):

$$P_D = C_{PD} \times V_{CC}^2 \times f_I + \sum (C_L \times V_{CC}^2 \times f_O) \text{ where:}$$

$f_I$  = input frequency in MHz,  $C_L$  = output load capacitance in pF,

$f_O$  = output frequency in MHz,  $V_{CC}$  = supply voltage in V,

$\sum (C_L \times V_{CC}^2 \times f_O)$  = sum of outputs

#### ORDERING INFORMATION

PACKAGES	TEMPERATURE RANGE	ORDER CODE
16-pin plastic DIP (300mil-wide)	-40°C to +85°C	74AC11239N 74ACT11239N
16-pin plastic SO (150mil-wide)	-40°C to +85°C	74AC11239D 74ACT11239D

#### PIN CONFIGURATION

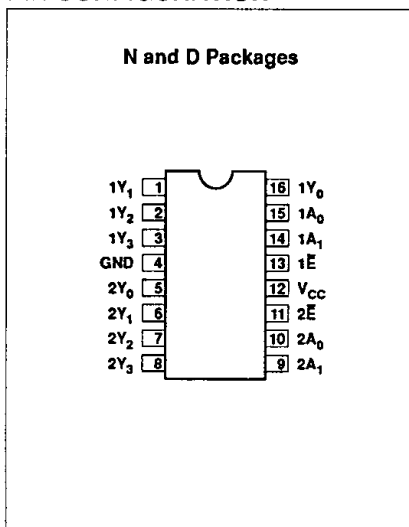

#### LOGIC SYMBOL

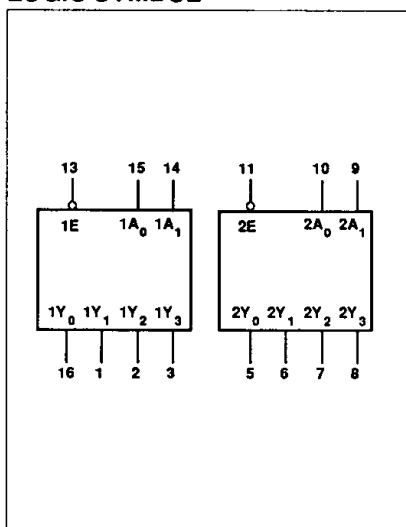

#### LOGIC SYMBOL (IEEE/IEC)

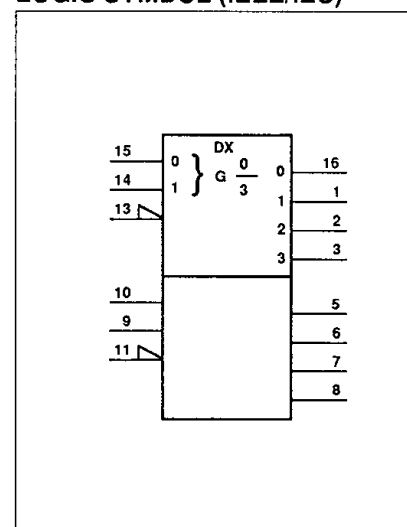

# Dual 2-to-4 line decoder/demultiplexer, active-High

74AC/ACT11239

## PIN DESCRIPTION

PIN NUMBER	SYMBOL	NAME AND FUNCTION
15, 14	1A <sub>0</sub> , 1A <sub>1</sub>	Address inputs, decoder 1
13	1 $\bar{E}$	Enable input (active Low), decoder 1
16, 1, 2, 3	1Y <sub>0</sub> to 1Y <sub>3</sub>	Outputs, decoder 1
10, 9	2A <sub>0</sub> , 2A <sub>1</sub>	Address inputs, decoder 2
11	2 $\bar{E}$	Enable input (active Low), decoder 2
5, 6, 7, 8	2Y <sub>0</sub> to 2Y <sub>3</sub>	Outputs, decoder 2
4	GND	Ground (0V)
12	V <sub>CC</sub>	Positive supply voltage

## FUNCTION TABLE

INPUTS			OUTPUTS			
$\bar{E}$	A <sub>0</sub>	A <sub>1</sub>	Y <sub>0</sub>	Y <sub>1</sub>	Y <sub>2</sub>	Y <sub>3</sub>
H	X	X	L	L	L	L
L	L	L	H	L	L	L
L	H	L	L	H	L	L
L	L	H	L	L	H	L
L	H	H	L	L	L	H

## LOGIC DIAGRAM

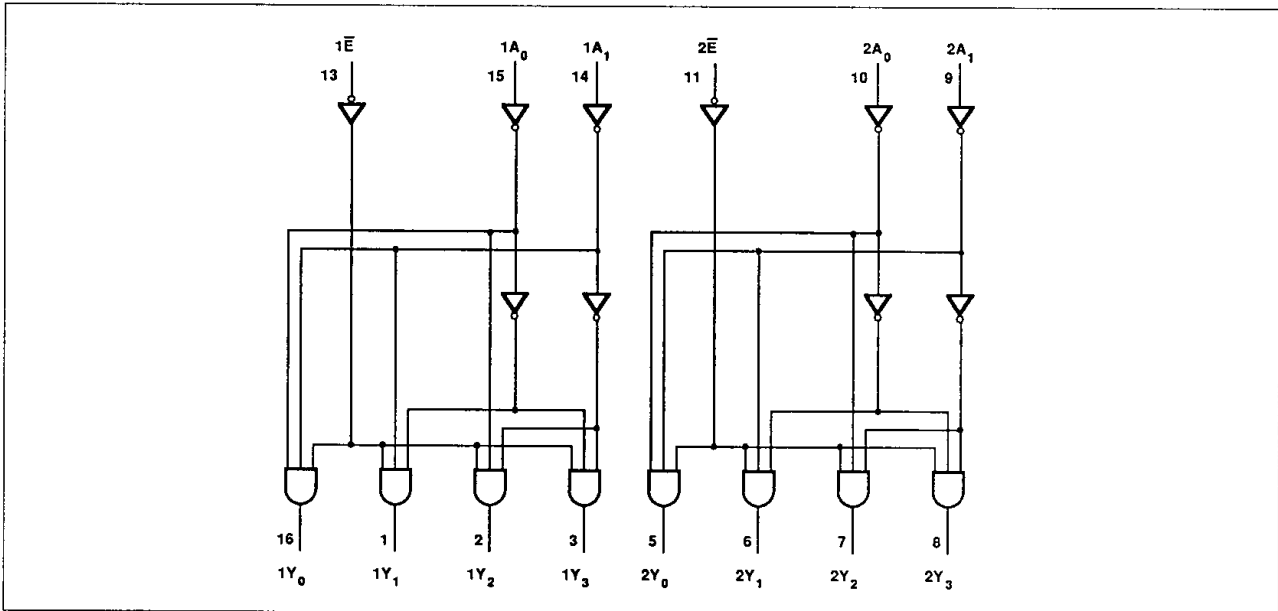

# Dual 2-to-4 line decoder/demultiplexer, active-High

## 74AC/ACT11239

### RECOMMENDED OPERATING CONDITIONS

SYMBOL	PARAMETER	74AC11239			74ACT11239			UNIT
		Min	Nom	Max	Min	Nom	Max	
$V_{CC}$	DC supply voltage	3.0 <sup>1</sup>	5.0	5.5	4.5	5.0	5.5	V
$V_I$	Input voltage	0		$V_{CC}$	0		$V_{CC}$	V
$V_O$	Output voltage	0		$V_{CC}$	0		$V_{CC}$	V
$\Delta V/\Delta t$	Input transition rise or fall rate	0		10	0		10	ns/V
$T_{amb}$	Operating free-air temperature range	-40		+85	-40		+85	°C

#### NOTE:

- No electrical or switching characteristics are specified at  $V_{CC} < 3V$ . Operation between 2V and 3V is not recommended, but within that range, a device output will maintain a previously established logic state.

### ABSOLUTE MAXIMUM RATINGS<sup>1</sup>

SYMBOL	PARAMETER	TEST CONDITIONS	RATING	UNIT
$V_{CC}$	DC supply voltage		-0.5 TO +7.0	V
$I_{IK}$ or $V_I$	DC input diode current <sup>2</sup>	$V_I < 0$	-20	mA
		$V_I > V_{CC}$	20	
	DC input voltage		-0.5 to $V_{CC} + 0.5$	V
$I_{OK}$ or $V_O$	DC output diode current <sup>2</sup>	$V_O < 0$	-50	mA
		$V_O > V_{CC}$	50	
	DC output voltage		-0.5 to $V_{CC} + 0.5$	V
$I_O$	DC output source or sink current per output pin	$V_O = 0$ to $V_{CC}$	±50	mA
$I_{CC}$ or $I_{GND}$	DC $V_{CC}$ current		±200	mA
	DC ground current		±200	
$T_{STG}$	Storage temperature		-65 to 150	°C
$P_{TOT}$	Power dissipation per package	Above 70°C; derate linearly by 8mW/K	500	mW
	Power dissipation per package Plastic surface mount (SO)	Above 70°C; derate linearly by 8mW/K	400	mW

#### NOTES:

- Stresses beyond those listed may cause permanent damage to the device. These are stress ratings only and functional operation of the device at these or any other conditions beyond those indicated under "recommended operating conditions" is not implied. Exposure to absolute-maximum-rated conditions for extended periods may affect device reliability.
- The input and output voltage ratings may be exceeded if the input and output current ratings are observed.

# Dual 2-to-4 line decoder/demultiplexer, active-High

## 74AC/ACT11239

### DC ELECTRICAL CHARACTERISTICS

SYMBOL	PARAMETER	TEST CONDITIONS	V <sub>CC</sub>	74AC11239				74ACT11239				UNIT	
				T <sub>amb</sub> = +25°C		T <sub>amb</sub> = -40°C to +85°C		T <sub>amb</sub> = +25°C		T <sub>amb</sub> = -40°C to +85°C			
				Min	Max	Min	Max	Min	Max	Min	Max		
V <sub>IH</sub>	High-level input voltage		3.0	2.10		2.10						V	
			4.5	3.15		3.15		2.0		2.0			
			5.5	3.85		3.85		2.0		2.0			
V <sub>IL</sub>	Low-level input voltage		3.0		0.90		0.90					V	
			4.5		1.35		1.35		0.8		0.8		
			5.5		1.65		1.65		0.8		0.8		
V <sub>OH</sub>	High-level output voltage	V <sub>I</sub> = V <sub>IL</sub> or V <sub>IH</sub>	I <sub>OH</sub> = -50μA	3.0	2.9		2.9					V	
				4.5	4.4		4.4		4.4		4.4		
				5.5	5.4		5.4		5.4		5.4		
			I <sub>OH</sub> = -4mA	3.0	2.58		2.48						
				4.5	3.94		3.8		3.94		3.8		
				5.5	4.94		4.8		4.94		4.8		
I <sub>OH</sub> = -75mA <sup>1</sup>	5.5			3.85				3.85					
V <sub>OL</sub>	Low-level output voltage	V <sub>I</sub> = V <sub>IL</sub> or V <sub>IH</sub>	I <sub>OL</sub> = 50μA	3.0		0.1		0.1				V	
				4.5		0.1		0.1		0.1			0.1
				5.5		0.1		0.1		0.1			0.1
			I <sub>OL</sub> = 12mA	3.0		0.36		0.44					
				4.5		0.36		0.44		0.36			0.44
				5.5		0.36		0.44		0.36			0.44
I <sub>OL</sub> = 75mA <sup>1</sup>	5.5				1.65				1.65				
I <sub>I</sub>	Input leakage current	V <sub>I</sub> = V <sub>CC</sub> or GND	5.5		±0.1		±1.0		±0.1		±1.0	μA	
I <sub>CC</sub>	Quiescent supply current	V <sub>I</sub> = V <sub>CC</sub> or GND, I <sub>0</sub> = 0mA	5.5		8.0		80		8.0		80	μA	
ΔI <sub>CC</sub>	Supply current, TTL inputs High <sup>2</sup>	One input at 3.4V, other inputs at V <sub>CC</sub> or GND	5.5						0.9		1.0	mA	

#### NOTES:

1. Not more than one output should be tested at a time, and the duration of the test should not exceed 10ms.
2. This is the increase in supply current for each input that is at one of the specified TTL voltage levels rather than 0V or V<sub>CC</sub>.

# Dual 2-to-4 line decoder/demultiplexer, active-High

74AC/ACT11239

## AC ELECTRICAL CHARACTERISTICS AT 3.3V ±0.3V

SYMBOL	PARAMETER	WAVEFORM	74AC11239					UNIT
			T <sub>amb</sub> = +25°C			T <sub>amb</sub> = -40°C to +85°C		
			Min	Typ	Max	Min	Max	
t <sub>PLH</sub> t <sub>PHL</sub>	Propagation delay nA <sub>n</sub> to nY <sub>n</sub>	1 and 2	1.5	6.2	8.5	1.5	9.5	ns
t <sub>PLH</sub> t <sub>PHL</sub>	Propagation delay n $\bar{E}$ to nY <sub>n</sub>	2	1.5	5.4	7.1	1.5	7.9	ns

## AC ELECTRICAL CHARACTERISTICS AT 5.0V ±0.5V

SYMBOL	PARAMETER	WAVEFORM	74AC11239					UNIT
			T <sub>amb</sub> = +25°C			T <sub>amb</sub> = -40°C to +85°C		
			Min	Typ	Max	Min	Max	
t <sub>PLH</sub> t <sub>PHL</sub>	Propagation delay nA <sub>n</sub> to nY <sub>n</sub>	1 and 2	1.5	4.0	6.1	1.5	6.7	ns
t <sub>PLH</sub> t <sub>PHL</sub>	Propagation delay n $\bar{E}$ to nY <sub>n</sub>	2	1.5	3.5	5.3	1.5	5.8	ns

## AC ELECTRICAL CHARACTERISTICS AT 5.0V ±0.5V

SYMBOL	PARAMETER	WAVEFORM	74ACT11239					UNIT
			T <sub>amb</sub> = +25°C			T <sub>amb</sub> = -40°C to +85°C		
			Min	Typ	Max	Min	Max	
t <sub>PLH</sub> t <sub>PHL</sub>	Propagation delay nA <sub>n</sub> to nY <sub>n</sub>	1 and 2	1.7	5.0	6.7	1.7	7.2	ns
t <sub>PLH</sub> t <sub>PHL</sub>	Propagation delay n $\bar{E}$ to nY <sub>n</sub>	2	1.5	3.8	5.8	1.5	6.2	ns

## AC WAVEFORMS

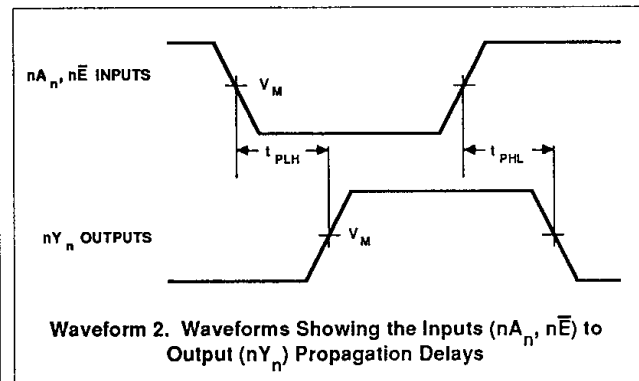
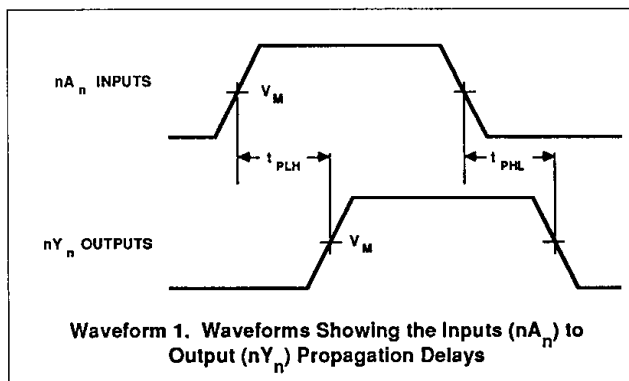

# Dual 2-to-4 line decoder/demultiplexer, active-High

74AC/ACT11239

### WAVEFORM CONDITIONS

	INPUTS	OUTPUTS
AC	$V_{IN} = \text{GND to } V_{CC}$ $V_M = 50\% V_{CC}$	$V_{OUT} = V_{OL} \text{ to } V_{OH}$
ACT	$V_{IN} = \text{GND to } 3.0V$ , $V_M = 1.5V$	$V_M = 50\% V_{CC}$

### TEST CIRCUIT

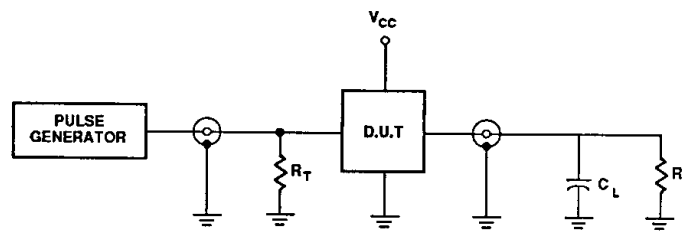

Test Circuit

#### DEFINITIONS

$C_L$  = Load capacitance, 50pF; includes jig and probe capacitance

$R_L$  = Load resistor, 500Ω

$R_T$  = Termination resistance should be equal to  $Z_{OUT}$  of pulse generators

Input pulses: PRR ≤ 10MHz

$t_r = t_f = 3ns$