

Document No.	853-1506
ECN No.	00733
Date of Issue	October 17, 1990
Status	Product Specification
ACL Products	

74AC/ACT11157

Quad 2-input multiplexer

FEATURES

- Output capability: ± 24 mA
- CMOS (AC) and TTL (ACT) voltage level inputs
- Center-pin V_{CC} and ground configuration to minimize high-speed switching noise
- I_{CC} category: MSI

DESCRIPTION

The 74AC/ACT11157 high-performance CMOS devices combine very high speed and high output drive comparable to the most advanced TTL families.

The 74AC/ACT11157 provides four 2-to-1 multiplexers with a common selector and a common enable. The state of the Select (S) input determines the particular input from which the data comes. The Enable (E) input is active-Low. When E is High, all of the outputs (Y) are forced Low regardless of all other input conditions.

The device is the logic implementation of a 4-pole, 2 position switch where the position of the switch is determined by the logic levels supplied to the Select input.

QUICK REFERENCE DATA

SYMBOL	PARAMETER	CONDITIONS $T_{amb} = 25^{\circ}C$; GND = 0V; $V_{CC} = 5.0V$	TYPICAL		UNIT
			AC	ACT	
t_{PLH}/t_{PHL}	Propagation delay nI_0, nI_1 to nY	$C_L = 50pF$	4.6	5.9	ns
C_{PD}	Power dissipation capacitance per multiplexer ¹	$f = 1MHz$; $C_L = 50pF$	36	36	pF
C_{IN}	Input capacitance	$V_I = 0V$ or V_{CC}	4.0	4.0	pF
I_{LATCH}	Latch-up current	Per Jeduc JC40.2 Standard 17	500	500	mA

Note:

1. C_{PD} is used to determine the dynamic power dissipation (P_D in μW):

$$P_D = C_{PD} \times V_{CC}^2 \times f_I + \sum (C_L \times V_{CC}^2 \times f_O) \text{ where:}$$

f_I = input frequency in MHz, C_L = output load capacitance in pF,

f_O = output frequency in MHz, V_{CC} = supply voltage in V,

$\sum (C_L \times V_{CC}^2 \times f_O)$ = sum of outputs

ORDERING INFORMATION

PACKAGES	TEMPERATURE RANGE	ORDER CODE
20-pin plastic DIP (300mil-wide)	-40°C to +85°C	74AC11157N 74ACT11157N
20-pin plastic SOL (300mil-wide)	-40°C to +85°C	74AC11157D 74ACT11157D

PIN CONFIGURATION

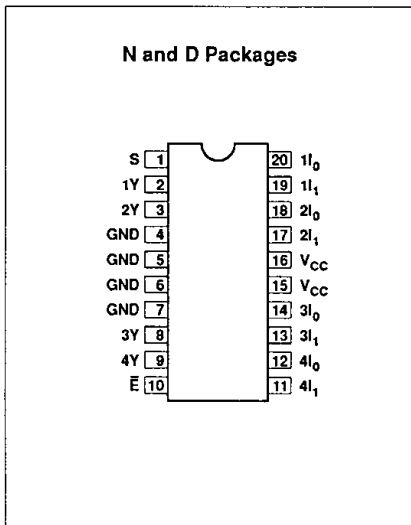

LOGIC SYMBOL

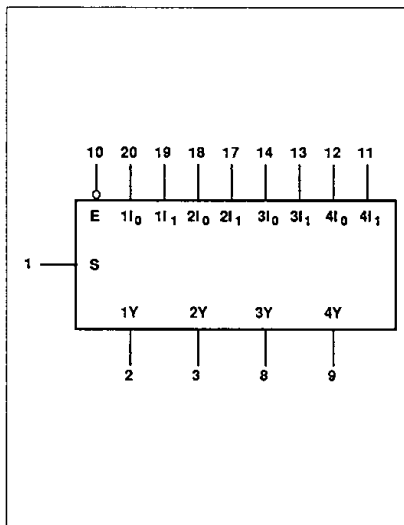

LOGIC SYMBOL (IEEE/IEC)

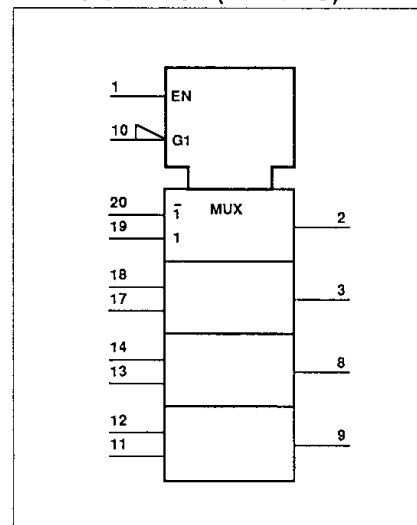

Quad 2-input multiplexer

74AC/ACT11157

LOGIC DIAGRAM

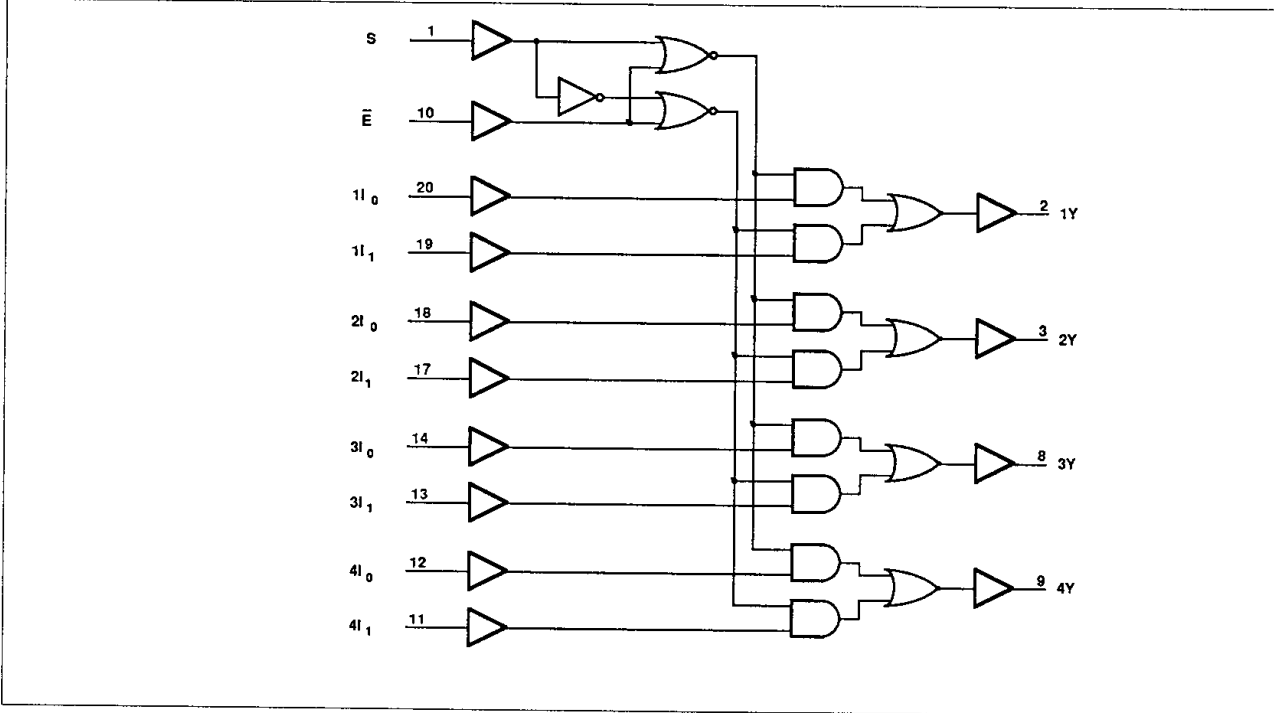

PIN DESCRIPTION

PIN NUMBER	SYMBOL	NAME AND FUNCTION
1	S	Common select input
20, 18, 14, 12	1I ₀ - 4I ₀	Data inputs
19, 17, 13, 11	1I ₁ - 4I ₁	Data inputs
2, 3, 8, 9	1Y - 4Y	Data outputs
10	\bar{E}	Output enable input
4, 5, 6, 7	GND	Ground (0V)
15, 16	V _{CC}	Positive supply voltage

FUNCTION TABLE

ENABLE	SELECT INPUT	DATA INPUTS		OUTPUT
		nI ₀	nI ₁	nY
H	X	X	X	L
L	L	L	X	L
L	L	H	X	H
L	H	X	L	L
L	H	X	H	H

Quad 2-input multiplexer

74AC/ACT11157

RECOMMENDED OPERATING CONDITIONS

SYMBOL	PARAMETER	74AC11157			74ACT11157			UNIT
		Min	Nom	Max	Min	Nom	Max	
V_{CC}	DC supply voltage	3.0 ¹	5.0	5.5	4.5	5.0	5.5	V
V_I	Input voltage	0		V_{CC}	0		V_{CC}	V
V_O	Output voltage	0		V_{CC}	0		V_{CC}	V
$\Delta V/\Delta v$	Input transition rise or fall rate	0		10	0		10	ns/V
T_{amb}	Operating free-air temperature range	-40		+85	-40		+85	°C

NOTE:

1. No electrical or switching characteristics are specified at $V_{CC} < 3V$. Operation between 2V and 3V is not recommended, but within that range, a device output will maintain a previously established logic state.

ABSOLUTE MAXIMUM RATINGS¹

SYMBOL	PARAMETER	TEST CONDITIONS	RATING	UNIT
V_{CC}	DC supply voltage		-0.5 TO +7.0	V
I_{IK} or V_I	DC input diode current ²	$V_I < 0$	-20	mA
		$V_I > V_{CC}$	20	
	DC input voltage		-0.5 to $V_{CC} + 0.5$	V
I_{OK} or V_O	DC output diode current ²	$V_O < 0$	-50	mA
		$V_O > V_{CC}$	50	
	DC output voltage		-0.5 to $V_{CC} + 0.5$	V
I_O	DC output source or sink current per output pin	$V_O = 0$ to V_{CC}	± 50	mA
I_{CC} or I_{GND}	DC V_{CC} current		± 100	mA
	DC ground current		± 100	
T_{STG}	Storage temperature		-65 to 150	°C
P_{TOT}	Power dissipation per package	Above 70°C; derate linearly by 8mW/K	500	mW
	Power dissipation per package Plastic surface mount (SO)	Above 70°C; derate linearly by 8mW/K	400	mW

NOTES:

1. Stresses beyond those listed may cause permanent damage to the device. These are stress ratings only and functional operation of the device at these or any other conditions beyond those indicated under "recommended operating conditions" is not implied. Exposure to absolute-maximum-rated conditions for extended periods may affect device reliability.
2. The input and output voltage ratings may be exceeded if the input and output current ratings are observed.

Quad 2-input multiplexer

74AC/ACT11157

DC ELECTRICAL CHARACTERISTICS

SYMBOL	PARAMETER	TEST CONDITIONS	V _{CC}	74AC11157				74ACT11157				UNIT	
				T _{amb} = +25°C		T _{amb} = -40°C to +85°C		T _{amb} = +25°C		T _{amb} = -40°C to +85°C			
				Min	Max	Min	Max	Min	Max	Min	Max		
V _{IH}	High-level input voltage		3.0	2.10		2.10						V	
			4.5	3.15		3.15		2.0		2.0			
			5.5	3.85		3.85		2.0		2.0			
V _{IL}	Low-level input voltage		3.0		0.90		0.90					V	
			4.5		1.35		1.35		0.8		0.8		
			5.5		1.65		1.65		0.8		0.8		
V _{OH}	High-level output voltage	V _I = V _{IL} or V _{IH}	I _{OH} = -50μA	3.0	2.9		2.9					V	
				4.5	4.4		4.4		4.4		4.4		
				5.5	5.4		5.4		5.4		5.4		
			I _{OH} = -4mA	3.0	2.58		2.48						
				4.5	3.94		3.8		3.94		3.8		
				5.5	4.94		4.8		4.94		4.8		
V _{OL}	Low-level output voltage	V _I = V _{IL} or V _{IH}	I _{OL} = 50μA	3.0		0.1		0.1				V	
				4.5		0.1		0.1		0.1			0.1
				5.5		0.1		0.1		0.1			0.1
			I _{OL} = 12mA	3.0		0.36		0.44					
				4.5		0.36		0.44		0.36			0.44
				5.5		0.36		0.44		0.36			0.44
I _{OL} = 24mA	3.0				1.65				1.65				
	5.5				1.65				1.65				
I _{OL} = 75mA ¹	3.0												
	5.5												
I _I	Input leakage current	V _I = V _{CC} or GND	5.5		±0.1		±1.0		±0.1		±1.0	μA	
I _{CC}	Quiescent supply current	V _I = V _{CC} or GND, I _O = 0mA	5.5		8.0		80		8.0		80	μA	
ΔI _{CC}	Supply current, TTL inputs High ²	One input at 3.4V, other inputs at V _{CC} or GND	5.5						0.9		1.0	mA	

NOTES:

- Not more than one output should be tested at a time, and the duration of the test should not exceed 10ms.
- This is the increase in supply current for each input that is at one of the specified TTL voltage levels rather than 0V or V_{CC}.

Quad 2-input multiplexer

74AC/ACT11157

AC ELECTRICAL CHARACTERISTICS AT 3.3V ±0.3V

SYMBOL	PARAMETER	WAVEFORM	74AC11157					UNIT
			T _{amb} = +25°C			T _{amb} = -40°C to +85°C		
			Min	Typ	Max	Min	Max	
t _{PLH} t _{PHL}	Propagation delay nI ₀ , nI ₁ to nY	1	1.8	6.2	8.5	1.8	9.5	ns
t _{PLH} t _{PHL}	Propagation delay S to nY	1	1.9	6.8	8.9	1.9	10.0	ns
t _{PLH} t _{PHL}	Propagation delay E̅ to nY	2	1.6	6.0	8.6	1.6	9.2	ns
			2.8	8.6	11.2	2.8	12.3	

AC ELECTRICAL CHARACTERISTICS AT 5.0V ±0.5V

SYMBOL	PARAMETER	WAVEFORM	74AC11157					UNIT
			T _{amb} = +25°C			T _{amb} = -40°C to +85°C		
			Min	Typ	Max	Min	Max	
t _{PLH} t _{PHL}	Propagation delay nI ₀ , nI ₁ to nY	1	1.5	3.9	5.8	1.5	6.4	ns
t _{PLH} t _{PHL}	Propagation delay S to nY	1	1.7	4.2	6.2	1.7	6.8	ns
t _{PLH} t _{PHL}	Propagation delay E̅ to nY	2	1.6	3.8	5.9	1.6	6.5	ns
			2.3	5.4	7.8	2.3	8.8	

AC ELECTRICAL CHARACTERISTICS AT 5.0V ±0.5V

SYMBOL	PARAMETER	WAVEFORM	74ACT11157					UNIT
			T _{amb} = +25°C			T _{amb} = -40°C to +85°C		
			Min	Typ	Max	Min	Max	
t _{PLH} t _{PHL}	Propagation delay nI ₀ , nI ₁ to nY	1	2.6	5.1	7.1	2.6	7.8	ns
t _{PLH} t _{PHL}	Propagation delay S to nY	1	2.3	5.6	8.7	2.3	9.5	ns
t _{PLH} t _{PHL}	Propagation delay E̅ to nY	2	2.1	5.1	7.9	2.1	8.6	ns
			3.6	6.9	9.7	3.6	10.8	

AC WAVEFORMS

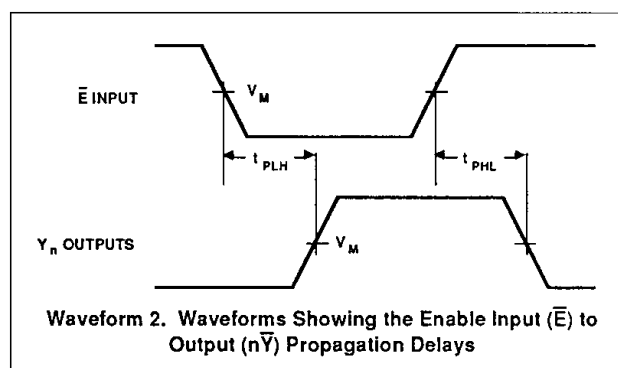
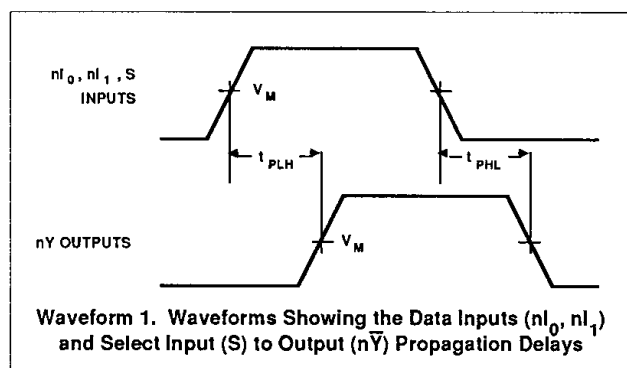

Quad 2-input multiplexer

74AC/ACT11157

WAVEFORM CONDITIONS

	INPUTS	OUTPUTS
AC	$V_{IN} = \text{GND to } V_{CC}$ $V_M = 50\% V_{CC}$	$V_{OUT} = V_{OL} \text{ to } V_{OH}$
ACT	$V_{IN} = \text{GND to } 3.0V$ $V_M = 1.5V$	$V_M = 50\% V_{CC}$

TEST CIRCUIT

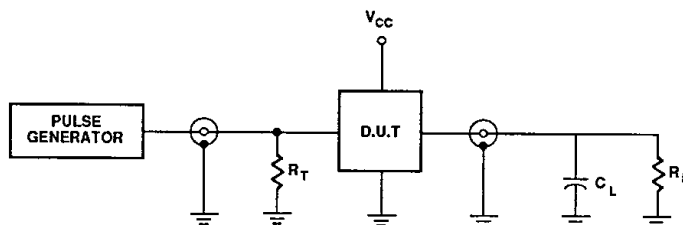

Test Circuit

DEFINITIONS

C_L = Load capacitance, 50pF; includes jig and probe capacitance

R_L = Load resistor, 500Ω

R_T = Termination resistance should be equal to Z_{OUT} of pulse generators

Input pulses: PRR ≤ 10MHz

$t_r = t_f = 3ns$