

DM74ALS5245/74ALS5245-1 Octal 3-STATE Transceiver

General Description

This octal bus transceiver is designed for asynchronous two-way communication between data buses. The inputs include hysteresis which provides improved noise rejection. Data is transmitted either from the A bus to the B bus or from the B bus to the A bus depending on the logic level of the direction control (DIR) input. The device can be disabled via the enable input (\bar{G}) which causes the outputs to enter the high impedance mode so the buses are effectively isolated. The ALS5245-1 features the same performance as the ALS5245 with the addition of increased current drive capability to meet the requirements of various bus architectures. The recommended maximum I_{OL} is increased to 48 mA.

Features

- Input Hysteresis
- Low output noise generation
- High input noise immunity
- Advanced oxide-isolated, ion implanted Schottky TTL process
- Switching specification guaranteed over the full temperature and V_{CC} range
- PNP inputs to reduce input loading
- Maximum I_{OL} is increased to 48 mA for ALS5245-1

Ordering Code:

Order Number	Package Number	Package Description
DM74ALS5245WM	M20B	20-Lead Small Outline Package – JEDEC (M)
DM74ALS5245SJ	M20D	20-Lead Small Outline Package – EIAJ (SJ)
DM74ALS5245N	N20A	20-Lead Molded Dual-in-Line Package (N)
DM74ALS5245-1WM	M20B	20-Lead Small Outline Package – JEDEC (M)
DM74ALS5245-1SJ	M20D	20-Lead Small Outline Package – EIAJ (SJ)
DM74ALS5245-1N	N20A	20-Lead Molded Dual-in-Line Package (N)

Device also available in Tape and Reel. Specify by appending suffix letter "X" to the ordering code.

Connection Diagram

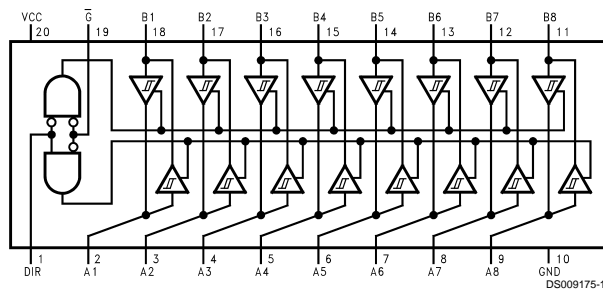

Function Table

Control Inputs		Operation
$\overline{\text{G}}$	DIR	
L	L	B Data to A Bus
L	H	A Data to B Bus
H	X	High Impedance

L = Low Logic Level, H = High Logic Level
X = Don't Care (Either Low or High Logic Level)

Absolute Maximum Ratings (Note 1)

Supply Voltage	7V	Operating Free-Air Temperature Range	DM74ALS	0°C to +70°C
Input Voltage		Storage Temperature Range		-65°C to +150°C
Control Inputs	7V	Typical θ_{JA}	N Package	56.0°C/W
I/O Ports	5.5V		M Package	74.0°C/W

Recommended Operating Conditions

Symbol	Parameter	DM74ALS5245		74ALS5245-1		Units
		Min	Max	Min	Max	
V_{CC}	Supply Voltage	4.5	5.5	4.5	5.5	V
V_{IH}	High Level Input Voltage	2		2		V
V_{IL}	Low Level Input Voltage		0.8		0.8	V
I_{OH}	High Level Output Current		-15		-15	mA
I_{OL}	Low Level Output Current		24		48	mA
T_A	Free Air Operating Temperature Range	0	70	0	70	°C

Note 1: The "Absolute Maximum Ratings" are those values beyond which the safety of the device cannot be guaranteed. The device should not be operated at these limits. The parametric values defined in the Electrical Characteristic tables are not guaranteed at the absolute maximum ratings. The "Recommended Operating Conditions" table will define the conditions for actual device operation.

ALS5245

Electrical Characteristics

over recommended free air temperature range. All typical values are measured at $V_{CC} = 5V$, $T_A = 25^\circ C$.

Symbol	Parameter	Test Conditions	DM74ALS5245			Units	
			Min	Typ	Max		
V_{IK}	Input Clamp Voltage	$V_{CC} = \text{Min}$, $I_I = -18 \text{ mA}$			-1.5	V	
H_{YS}	Hysteresis ($V_{T+} - V_{T-}$)	$V_{CC} = \text{Min}$	0.2	0.32		V	
V_{OH}	High Level Output Voltage	$V_{CC} = 4.5V \text{ to } 5.5V$	$I_{OH} = -0.4 \text{ mA}$	$V_{CC} - 2$		V	
		$V_{CC} = \text{Min}$	$I_{OH} = -3 \text{ mA}$	2.4	3.2		
			$I_{OH} = \text{Max}$	2			
V_{OL}	Low Level Output Voltage	$V_{CC} = \text{Min}$	$I_{OL} = 12 \text{ mA}$		0.25	0.4	V
			$I_{OL} = 24 \text{ mA}$		0.35	0.5	
I_I	Input Current at Maximum Input Voltage	$V_{CC} = \text{Max}$	I/O Ports, $V_I = 5.5V$			100	μA
			Control Inputs, $V_I = 7V$			100	
I_{IH}	High Level Input Current	$V_{CC} = \text{Max}$, $V_I = 2.7V$				20	μA
I_{IL}	Low Level Input Current	$V_{CC} = \text{Max}$, $V_I = 0.4V$				-100	μA
I_O	Output Drive Current	$V_{CC} = \text{Max}$, $V_O = 2.25V$		-30		-112	mA
I_{CC}	Supply Current	$V_{CC} = \text{Max}$	Outputs High		30	45	mA
			Outputs Low		36	55	
			Outputs Disabled		38	58	
V_{OLP}	Quiet Output Maximum Dynamic V_{OL}	$V_{CC} = 5.0V$, $T_A = 25^\circ C$ (Figures 1, 2; (Notes 2, 3))			0.5		V
V_{OLV}	Quiet Output Minimum Dynamic V_{OL}	$V_{CC} = 5.0V$, $T_A = 25^\circ C$ (Figures 1, 2; (Notes 2, 3))			-0.2		V
V_{IHD}	Minimum High Level Dynamic Input Voltage	$V_{CC} = 5.0V$, $T_A = 25^\circ C$ (Notes 2, 4)			1.6		V
V_{ILD}	Maximum Low Level Dynamic Input Voltage	$V_{CC} = 5.0V$, $T_A = 25^\circ C$ (Notes 2, 4)			1.0		V

Note 2: Plastic DIP package.

Note 3: n = number of device outputs; n-1 outputs switching, each driven 0V to 3V one output @ GND.

Note 4: n = number of device outputs; n outputs switching, n-1 inputs switching 0V to 3V. Input under test switching 3V to threshold (V_{ILD}); 0V to threshold (V_{IHD}); f = 1 MHz.

Switching Characteristics

over recommended operating free air temperature range (Note 5)

Symbol	Parameter	Conditions	From (Input) To (Output)	DM74ALS5245		Units
				Min	Max	
t _{PLH}	Propagation Delay Time Low to High Level Output	V _{CC} = 4.5V to 5.5V, R ₁ = R ₂ = 500Ω, C _L = 50 pF	A or B to B or A	3	10	ns
t _{PHL}	Propagation Delay Time High to Low Level Output		A or B to B or A	3	10	ns
t _{PZH}	Output Enable Time to High Level Output		\overline{G} to A or B	5	20	ns
t _{PZL}	Output Enable Time to Low Level Output		\overline{G} to A or B	5	20	ns
t _{PHZ}	Output Disable Time from High Level Output		\overline{G} to A or B	2	10	ns
t _{PLZ}	Output Disable Time from Low Level Output		\overline{G} to A or B	4	15	ns

Note 5: See Section 5 for test waveforms and output load.

ALS5245-1

Electrical Characteristics

over recommended free air temperature range

Symbol	Parameter	Test Conditions	74ALS5245-1			Units	
			Min	Typ	Max		
V _{IC}	Input Clamp Voltage	V _{CC} = Min, I _I = -18 mA			-1.5	V	
H _{YS}	Hysteresis (V _{T+} - V _{T-})	V _{CC} = Min	0.2	0.32		V	
V _{OH}	High Level Output Voltage	V _{CC} = 4.5V to 5.5V	I _{OH} = -0.4 mA		V _{CC} - 2	V	
		V _{CC} = Min	I _{OH} = -3 mA		2.4		3.2
			I _{OH} = Max		2		
V _{OL}	Low Level Output Voltage	V _{CC} = Min	I _{OL} = 48 mA		0.45	0.53	V
I _I	Input Current at Maximum Input Voltage	V _{CC} = Max	I/O Ports, V _I = 5.5V			100	μA
			Control Inputs, V _I = 7V			100	
I _{IH}	High Level Input Current	V _{CC} = Max, V _I = 2.7V (Note 6)				20	μA
I _{IL}	Low Level Input Current	V _{CC} = Max, V _I = 0.4V (Note 6)				-100	μA
I _O	Output Drive Current	V _{CC} = Max, V _O = 2.25V	-30			-112	mA
I _{CC}	Supply Current	V _{CC} = Max	Outputs High		30	45	mA
			Outputs Low		36	55	
			Outputs Disabled		38	58	

Note 6: For I/O ports, I_{IH} and I_{IL} parameters include the 3-STATE output currents (I_{OZL} and I_{OZH}).

Switching Characteristics

over recommended operating free air temperature range (Note 7)

Symbol	Parameter	Conditions	From (Input) To (Output)	74ALS5245-1		Units
				Min	Max	
t_{PLH}	Propagation Delay Time Low to High Level Output	$V_{CC} = 4.5V$ to $5.5V$, $R_1 = R_2 = 500\Omega$, $C_L = 50$ pF	A or B to B or A	2	10	ns
t_{PHL}	Propagation Delay Time High to Low Level Output		A or B to B or A	3	10	ns
t_{PZH}	Output Enable Time to High Level Output		\overline{G} to A or B	4	20	ns
t_{PZL}	Output Enable Time to Low Level Output		\overline{G} to A or B	5	20	ns
t_{PHZ}	Output Disable Time from High Level Output		\overline{G} to A or B	1	10	ns
t_{PLZ}	Output Disable Time from Low Level Output		\overline{G} to A or B	3	15	ns

Note 7: See Section 5 for test waveforms and output load.

ALS Noise Characteristics

The setup of a noise characteristics measurement is critical to the accuracy and repeatability of the tests. The following is a brief description of the setup used to measure the noise characteristics of ALS.

Equipment:

- Word Generator
- Printed Circuit Board Test Fixture
- Dual Trace Oscilloscope

Procedure:

1. Verify Test Fixture Loading: Standard Load 50 pF, 500Ω.
2. Deskew the word generator so that no two channels have greater than 150 ps skew between them. This requires that the oscilloscope be deskewed first. Swap out the channels that have more than 150 ps of skew until all channels being used are within 150 ps. It is important to deskew the word generator channels before testing. This will ensure that the outputs switch simultaneously.
3. Terminate all inputs and outputs to ensure proper loading of the outputs and that the input levels are at the correct voltage.
4. Set V_{CC} to 5.0V.
5. Set the word generator to toggle all but one output at a frequency of 1 MHz. Greater frequencies will increase DUT heating and affect the results of the measurement.
6. Set the word generator input levels at 0V LOW and 3V HIGH. Verify levels with a digital volt meter.

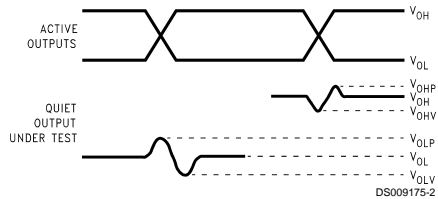

FIGURE 1. Quiet Output Noise Voltage Waveforms

Note 8: V_{OHV} and V_{OHP} are measured with respect to V_{OH} reference. V_{OLV} and V_{OLP} are measured with respect to ground reference.

Note 9: Input pulses have the following characteristics: $f = 1$ MHz, $t_r = 3$ ns, $t_f = 3$ ns, skew < 150 ps.

V_{OLP}/V_{OLV} and V_{OHP}/V_{OHV} :

- Determine the quiet output pin that demonstrates the greatest noise levels. The worst case pin will usually be the furthest from the ground pin. Monitor the output voltages using a 50Ω coaxial cable plugged into a standard SMB type connector on the test fixture. Do not use an active FET probe.
- Measure V_{OLP} and V_{OLV} on the quiet output during the HL transition. Measure V_{OHP} and V_{OHV} on the quiet output during the LH transition.
- Verify that the GND reference recorded on the oscilloscope has not drifted to ensure the accuracy and repeatability of the measurements.

V_{ILD} and V_{IHD} :

- Monitor one of the switching outputs using a 50Ω coaxial cable plugged into a standard SMB type connector on the test fixture. Do not use an active FET probe.
- First increase the input LOW voltage level, V_{IL} , until the output begins to oscillate. Oscillation is defined as noise on the output LOW level that exceeds V_{IL} limits, or on output HIGH levels that exceed V_{IH} limits. The input LOW voltage level at which oscillation occurs is defined as V_{ILD} .
- Next decrease the input HIGH voltage level on the word generator, V_{IH} until the output begins to oscillate. Oscillation is defined as noise on the output LOW level that exceeds V_{IL} limits, or on output HIGH levels that exceed V_{IH} limits. The input HIGH voltage level at which oscillation occurs is defined as V_{IHD} .
- Verify that the GND reference recorded on the oscilloscope has not drifted to ensure the accuracy and repeatability of the measurements.

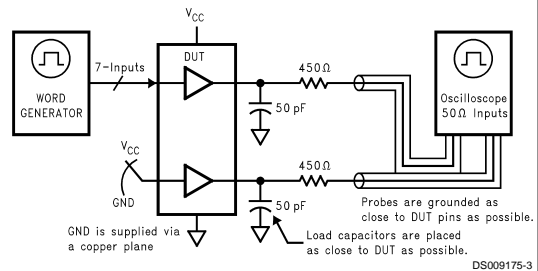
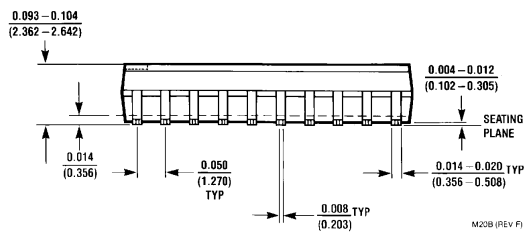
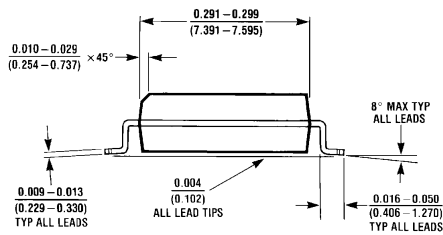
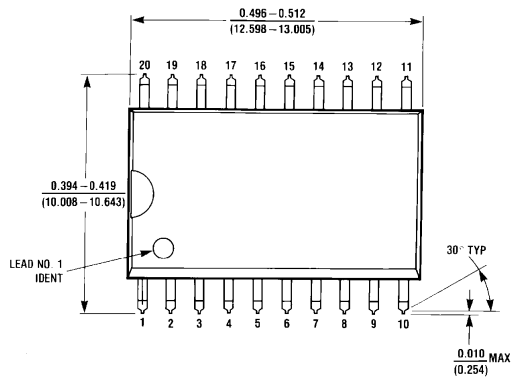

FIGURE 2. Simultaneous Switching Test Circuit

Physical Dimensions inches (millimeters) unless otherwise noted



M20B (REV F)

**Small Outline Package-JEDEC (M)
Package Number M20B**

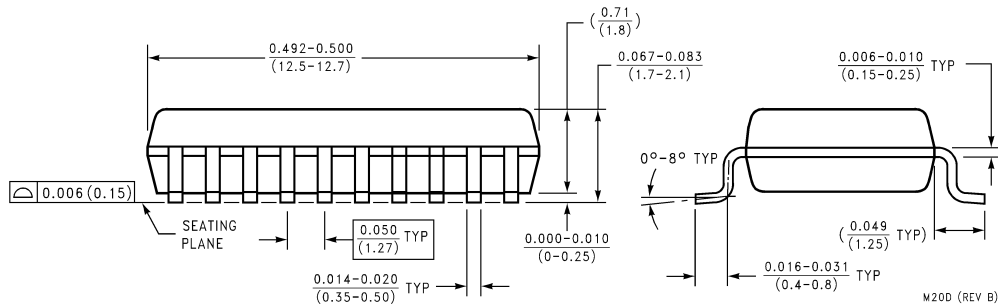
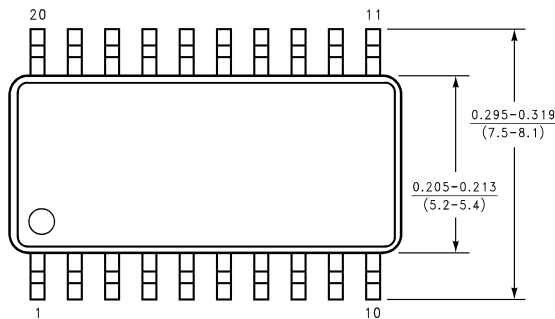

M20D (REV B)

**Small Outline Package-EIAJ (SJ)
Package Number M20D**

Physical Dimensions inches (millimeters) unless otherwise noted (Continued)

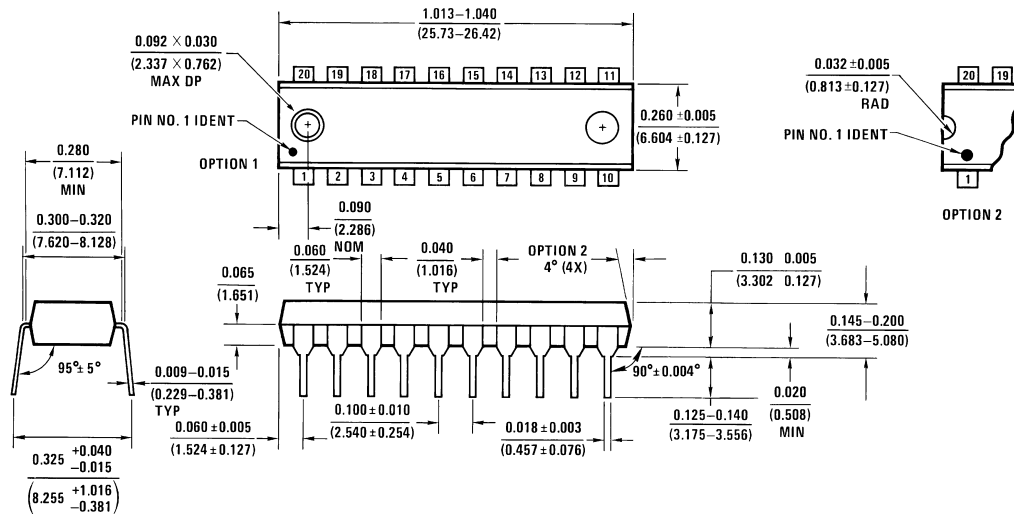

**Molded Dual-In-Line Package (N)
Package Number N20A**

N20A (REV G)

LIFE SUPPORT POLICY

FAIRCHILD'S PRODUCTS ARE NOT AUTHORIZED FOR USE AS CRITICAL COMPONENTS IN LIFE SUPPORT DEVICES OR SYSTEMS WITHOUT THE EXPRESS WRITTEN APPROVAL OF THE PRESIDENT OF FAIRCHILD SEMICONDUCTOR CORPORATION. As used herein:

1. Life support devices or systems are devices or systems which, (a) are intended for surgical implant into the body, or (b) support or sustain life, and (c) whose failure to perform when properly used in accordance with instructions for use provided in the labeling, can be reasonably expected to result in a significant injury to the user.
2. A critical component in any component of a life support device or system whose failure to perform can be reasonably expected to cause the failure of the life support device or system, or to affect its safety or effectiveness.

Fairchild Semiconductor Corporation Americas
Customer Response Center
Tel: 1-888-522-5372

Fairchild Semiconductor Europe
Fax: +49 (0) 1 80-530 85 86
Email: europe.support@nsc.com
Deutsch Tel: +49 (0) 8 141-35-0
English Tel: +44 (0) 1 793-85-68-56
Italy Tel: +39 (0) 2 57 5631

Fairchild Semiconductor Hong Kong Ltd.
13th Floor, Straight Block,
Ocean Centre, 5 Canton Rd.
Tsimshatsui, Kowloon
Hong Kong
Tel: +852 2737-7200
Fax: +852 2314-0061

National Semiconductor Japan Ltd.
Tel: 81-3-5620-6175
Fax: 81-3-5620-6179

www.fairchildsemi.com