

74ALVCH16374

Low Voltage 16-Bit D-Type Flip-Flop with Bushold

General Description

The ALVCH16374 contains sixteen non-inverting D-type flip-flops with 3-STATE outputs and is intended for bus oriented applications. The device is byte controlled. A buffered clock (CP) and output enable (\overline{OE}) are common to each byte and can be shorted together for full 16-bit operation.

The ALVCH16374 data inputs include active bushold circuitry, eliminating the need for external pull-up resistors to hold unused or floating data inputs at a valid logic level.

The 74ALVCH16374 is designed for low voltage (1.65V to 3.6V) V_{CC} applications with output compatibility up to 3.6V.

The 74ALVCH16374 is fabricated with an advanced CMOS technology to achieve high speed operation while maintaining low CMOS power dissipation.

Features

- 1.65V to 3.6V V_{CC} supply operation
- 3.6V tolerant control inputs and outputs
- Bushold on data inputs eliminates the need for external pull-up/pull-down resistors
- t_{PD}
 - 4.2 ns max for 3.0V to 3.6V V_{CC}
 - 5.3 ns max for 2.3V to 2.7V V_{CC}
 - 7.8 ns max for 1.65V to 1.95V V_{CC}
- Uses patented noise/EMI reduction circuitry
- Latch-up conforms to JEDEC JED78
- ESD performance:
 - Human body model > 2000V
 - Machine model > 200V

Ordering Code:

Order Number	Package Number	Package Descriptions
74ALVCH16374T (Note 1)	MTD48	48-Lead Thin Shrink Small Outline Package (TSSOP), JEDEC MO-153, 6.1mm Wide

Note 1: Devices also available in Tape and Reel. Specify by appending suffix letter "X" to the ordering code.

Logic Symbol

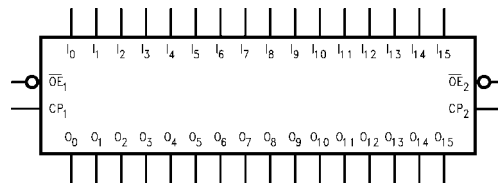

Connection Diagrams

Pin Assignment for TSSOP

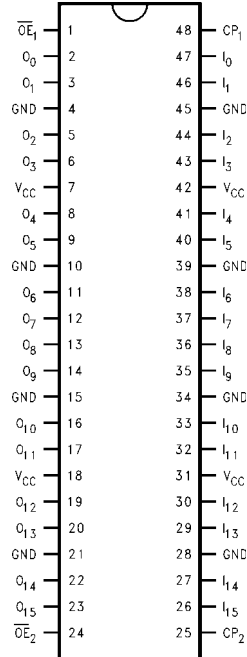

Pin Assignment for FBGA

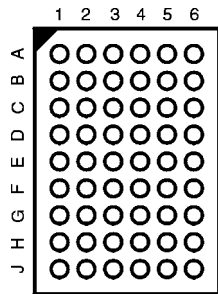

(Top Thru View)

Pin Descriptions

Pin Names	Description
\overline{OE}_n	Output Enable Input (Active LOW)
CP _n	Clock Pulse Input
I ₀ -I ₁₅	Bushold Inputs
O ₀ -O ₁₅	Outputs
NC	No Connect

FBGA Pin Assignments

	1	2	3	4	5	6
A	O ₀	NC	\overline{OE}_1	CP ₁	NC	I ₀
B	O ₂	O ₁	NC	NC	I ₁	I ₂
C	O ₄	O ₃	V _{CC}	V _{CC}	I ₃	I ₄
D	O ₆	O ₅	GND	GND	I ₅	I ₆
E	O ₈	O ₇	GND	GND	I ₇	I ₈
F	O ₁₀	O ₉	GND	GND	I ₉	I ₁₀
G	O ₁₂	O ₁₁	V _{CC}	V _{CC}	I ₁₁	I ₁₂
H	O ₁₄	O ₁₃	NC	NC	I ₁₃	I ₁₄
J	O ₁₅	NC	\overline{OE}_2	CP ₂	NC	I ₁₅

Truth Tables

Inputs			Outputs
CP ₁	\overline{OE}_1	I ₀ -I ₇	O ₀ -O ₇
↗	L	H	H
↗	L	L	L
L	L	X	O ₀
X	H	X	Z

Inputs			Outputs
CP ₂	\overline{OE}_2	I ₈ -I ₁₅	O ₈ -O ₁₅
↗	L	H	H
↗	L	L	L
L	L	X	O ₀
X	H	X	Z

H = HIGH Voltage Level
 L = LOW Voltage Level
 X = Immaterial (HIGH or LOW, control inputs may not float)
 Z = High Impedance
 O₀ = Previous O₀ before HIGH-to-LOW of CP

Functional Description

The 74ALVCH16374 consists of sixteen edge-triggered flip-flops with individual D-type inputs and 3-STATE true outputs. The device is byte controlled with each byte functioning identically, but independent of the other. The control pins can be shorted together to obtain full 16-bit operation. Each clock has a buffered clock and buffered Output Enable common to all flip-flops within that byte. The description which follows applies to each byte. Each

flip-flop will store the state of their individual I inputs that meet the setup and hold time requirements on the LOW-to-HIGH Clock (CP_n) transition. With the Output Enable (\overline{OE}_n) LOW, the contents of the flip-flops are available at the outputs. When \overline{OE}_n is HIGH, the outputs go to the high impedance state. Operations of the \overline{OE}_n input does not affect the state of the flip-flops.

Logic Diagram

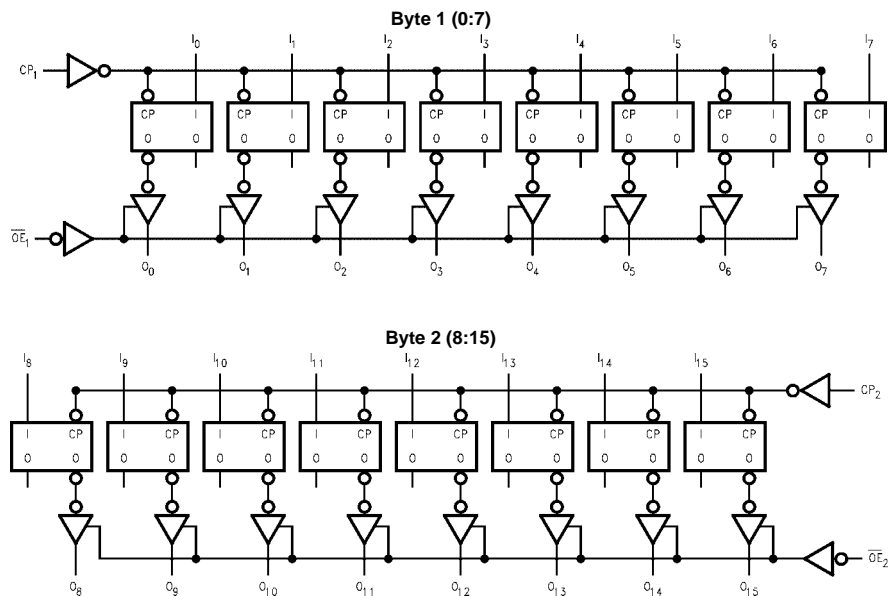

Please note that this diagram is provided only for the understanding of logic operations and should not be used to estimate propagation delays.

Absolute Maximum Ratings (Note 2)

Supply Voltage (V_{CC})	-0.5V to +4.6V
DC Input Voltage (V_I)	-0.5V to 4.6V
Output Voltage (V_O) (Note 3)	-0.5V to $V_{CC} + 0.5V$
DC Input Diode Current (I_{IK}) $V_I < 0V$	-50 mA
DC Output Diode Current (I_{OK}) $V_O < 0V$	-50 mA
DC Output Source/Sink Current (I_{OH}/I_{OL})	± 50 mA
DC V_{CC} or GND Current per Supply Pin (I_{CC} or GND)	± 100 mA
Storage Temperature Range (T_{STG})	-65°C to +150°C

Recommended Operating Conditions (Note 4)

Power Supply	
Operating	1.65V to 3.6V
Input Voltage (V_I)	0V to V_{CC}
Output Voltage (V_O)	0V to V_{CC}
Free Air Operating Temperature (T_A)	-40°C to +85°C
Minimum Input Edge Rate ($\Delta t/\Delta V$) $V_{IN} = 0.8V$ to $2.0V$, $V_{CC} = 3.0V$	10 ns/V

Note 2: The Absolute Maximum Ratings are those values beyond which the safety of the device cannot be guaranteed. The device should not be operated at these limits. The parametric values defined in the Electrical Characteristics tables are not guaranteed at the Absolute Maximum Ratings. The "Recommended Operating Conditions" table will define the conditions for actual device operation.

Note 3: I_O Absolute Maximum Rating must be observed.

Note 4: Floating or unused control inputs must be held HIGH or LOW.

DC Electrical Characteristics

Symbol	Parameter	Conditions	V_{CC} (V)	Min	Max	Units
V_{IH}	HIGH Level Input Voltage		1.65 - 1.95 2.3 - 2.7 2.7 - 3.6	$0.65 \times V_{CC}$ 1.7 2.0		V
V_{IL}	LOW Level Input Voltage		1.65 - 1.95 2.3 - 2.7 2.7 - 3.6		$0.35 \times V_{CC}$ 0.7 0.8	V
V_{OH}	HIGH Level Output Voltage	$I_{OH} = 100 \mu A$ $I_{OH} = -4$ mA $I_{OH} = -6$ mA $I_{OH} = -12$ mA $I_{OH} = -24$ mA	1.65 - 3.6 1.65 2.3 2.7 3.0 3.0	$V_{CC} - 0.2$ 1.2 2.0 1.7 2.2 2.4		V
V_{OL}	LOW Level Output Voltage	$I_{OL} = 100 \mu A$ $I_{OL} = 4$ mA $I_{OL} = 6$ mA $I_{OL} = 12$ mA $I_{OL} = 24$ mA	1.65 - 3.6 1.65 2.3 2.7 3.0		0.2 0.45 0.4 0.7 0.4 0.55	V
I_I	Input Leakage Current	$0 \leq V_I \leq 3.6V$	3.6		± 5.0	μA
$I_{I(HOLD)}$	Bushold Input Maximum Drive Hold Current	$V_{IN} = 0.58V$ $V_{IN} = 1.07V$ $V_{IN} = 0.7V$ $V_{IN} = 1.7V$ $V_{IN} = 0.8V$ $V_{IN} = 2.0V$ $0 < V_O \leq 3.6V$	1.65 1.65 2.3 2.3 3.0 3.0 3.6	25 -25 45 -45 75 -75		μA
I_{OZ}	3-STATE Output Leakage	$0 \leq V_O \leq 3.6V$	3.6		± 10	μA
I_{CC}	Quiescent Supply Current	$V_I = V_{CC}$ or GND, $I_O = 0$	3.6		40	μA
ΔI_{CC}	Increase in I_{CC} per Input	$V_{IH} = V_{CC} - 0.6V$	3 - 3.6		750	μA

AC Electrical Characteristics

Symbol	Parameter	$T_A = -40^{\circ}\text{C to } +85^{\circ}\text{C}, R_L = 500\Omega$								Units
		$C_L = 50\text{ pF}$				$C_L = 30\text{ pF}$				
		$V_{CC} = 3.3\text{V} \pm 0.3\text{V}$		$V_{CC} = 2.7\text{V}$		$V_{CC} = 2.5\text{V} \pm 0.2\text{V}$		$V_{CC} = 1.8\text{V} \pm 0.15\text{V}$		
		Min	Max	Min	Max	Min	Max	Min	Max	
f_{CLOCK}	Clock Frequency		150		150		150		100	MHz
t_W	Pulse Width	3.3		3.3		3.3		4.0		ns
t_S	Setup Time	1.9		2.2		2.1		2.5		ns
t_H	Hold Time	0.5		0.5		0.6		1.0		ns
f_{MAX}	Maximum Clock Frequency	150		150		150		100		MHz
$t_{\text{PHL}}, t_{\text{PLH}}$	Propagation Delay	1.0	4.2		4.9	1.0	5.3	1.5	7.8	ns
$t_{\text{PZL}}, t_{\text{PZH}}$	Output Enable Time	1.0	4.8		5.9	1.0	6.2	1.5	9.2	ns
$t_{\text{PLZ}}, t_{\text{PHZ}}$	Output Disable Time	1.0	4.3		4.7	1.0	5.3	1.5	6.8	ns

Capacitance

Symbol	Parameter	Conditions	$T_A = +25^{\circ}\text{C}$		Units	
			V_{CC}	Typical		
C_{IN}	Input Capacitance	Control	$V_I = 0\text{V or } V_{CC}$	3.3	3	pF
		Data	$V_I = 0\text{V or } V_{CC}$	3.3	6	
C_{OUT}	Output Capacitance		$V_I = 0\text{V or } V_{CC}$	3.3	7	pF
C_{PD}	Power Dissipation Capacitance	Outputs Enabled	$f = 10\text{ MHz}, C_L = 50\text{ pF}$	3.3	30	pF
				2.5	31	
		Outputs Disabled	$f = 10\text{ MHz}, C_L = 50\text{ pF}$	3.3	18	
				2.5	16	

AC Loading and Waveforms

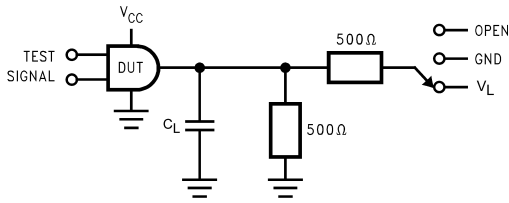

FIGURE 1. AC Test Circuit

TABLE 1. Values for Figure 1

TEST	SWITCH
t_{PLH} , t_{PHL}	Open
t_{PZL} , t_{PLZ}	V_L
t_{PZH} , t_{PHZ}	GND

TABLE 2. Variable Matrix
(Input Characteristics: $f = 1\text{MHz}$; $t_r = t_f = 2\text{ns}$; $Z_0 = 50\Omega$)

Symbol	V_{CC}			
	$3.3\text{V} \pm 0.3\text{V}$	2.7V	$2.5\text{V} \pm 0.2\text{V}$	$1.8\text{V} \pm 0.15\text{V}$
V_{mi}	1.5V	1.5V	$V_{CC}/2$	$V_{CC}/2$
V_{mo}	1.5V	1.5V	$V_{CC}/2$	$V_{CC}/2$
V_X	$V_{OL} + 0.3\text{V}$	$V_{OL} + 0.3\text{V}$	$V_{OL} + 0.15\text{V}$	$V_{OL} + 0.15\text{V}$
V_Y	$V_{OH} - 0.3\text{V}$	$V_{OH} - 0.3\text{V}$	$V_{OH} - 0.15\text{V}$	$V_{OH} - 0.15\text{V}$
V_L	6V	6V	$V_{CC} \cdot 2$	$V_{CC} \cdot 2$

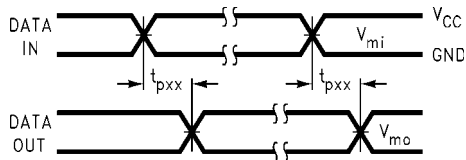

FIGURE 2. Waveform for Inverting and Non-Inverting Functions

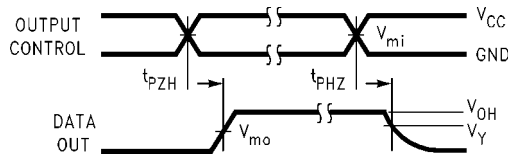

FIGURE 3. 3-STATE Output High Enable and Disable Times for Low Voltage Logic

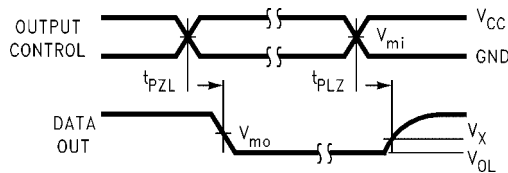

FIGURE 4. 3-STATE Output Low Enable and Disable Times for Low Voltage Logic

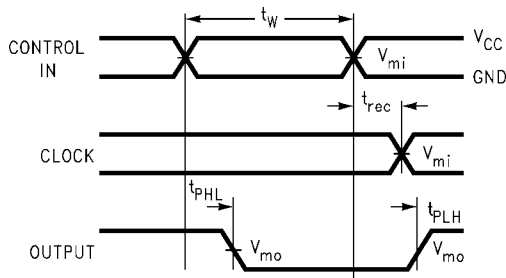

FIGURE 5. Propagation Delay, Pulse Width and t_{REC} Waveforms

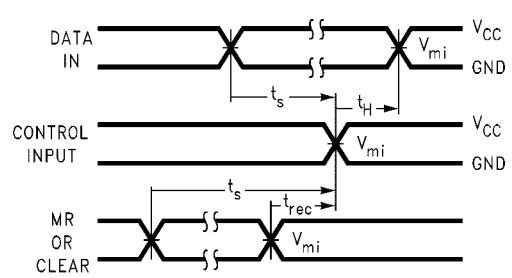
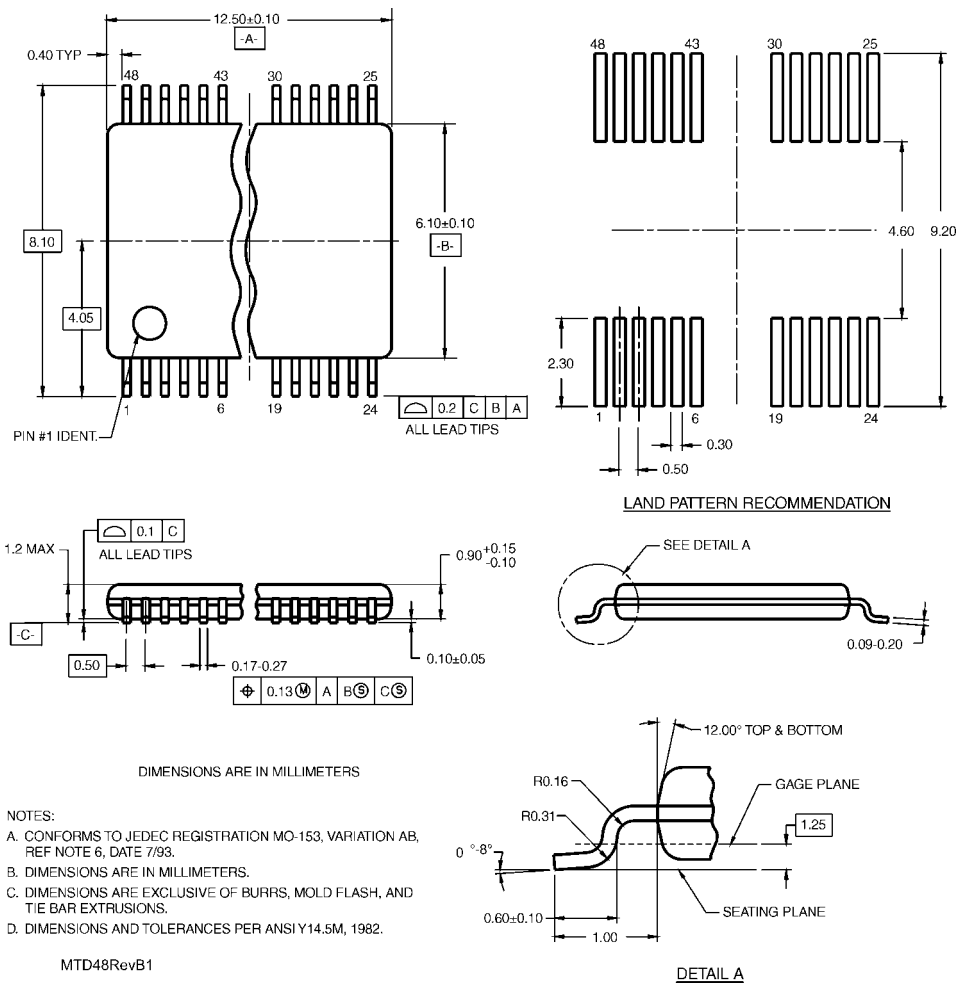

FIGURE 6. Setup Time, Hold Time and Recovery Time for Low Voltage Logic

Physical Dimensions inches (millimeters) unless otherwise noted



48-Lead Thin Shrink Small Outline Package (TSSOP), JEDEC MO-153, 6.1mm Wide Package Number MTD48

Fairchild does not assume any responsibility for use of any circuitry described, no circuit patent licenses are implied and Fairchild reserves the right at any time without notice to change said circuitry and specifications.

LIFE SUPPORT POLICY

FAIRCHILD'S PRODUCTS ARE NOT AUTHORIZED FOR USE AS CRITICAL COMPONENTS IN LIFE SUPPORT DEVICES OR SYSTEMS WITHOUT THE EXPRESS WRITTEN APPROVAL OF THE PRESIDENT OF FAIRCHILD SEMICONDUCTOR CORPORATION. As used herein:

1. Life support devices or systems are devices or systems which, (a) are intended for surgical implant into the body, or (b) support or sustain life, and (c) whose failure to perform when properly used in accordance with instructions for use provided in the labeling, can be reasonably expected to result in a significant injury to the user.
2. A critical component in any component of a life support device or system whose failure to perform can be reasonably expected to cause the failure of the life support device or system, or to affect its safety or effectiveness.

www.fairchildsemi.com