

# 74AUP1G11

## Low-power 3-input AND gate

Rev. 01 — 4 September 2007

Product data sheet

## 1. General description

The 74AUP1G11 provides a low-power, low-voltage single 3-input AND gate.

Schmitt trigger action at all inputs makes the circuit tolerant to slower input rise and fall times across the entire  $V_{CC}$  range from 0.8 V to 3.6 V.

This device ensures a very low static and dynamic power consumption across the entire  $V_{CC}$  range from 0.8 V to 3.6 V.

This device is fully specified for partial power-down applications using  $I_{OFF}$ . The  $I_{OFF}$  circuitry disables the output, preventing the damaging backflow current through the device when it is powered down.

## 2. Features

- Wide supply voltage range from 0.8 V to 3.6 V
- High noise immunity
- Complies with JEDEC standards:
  - ◆ JESD8-12 (0.8 V to 1.3 V)
  - ◆ JESD8-11 (0.9 V to 1.65 V)
  - ◆ JESD8-7 (1.2 V to 1.95 V)
  - ◆ JESD8-5 (1.8 V to 2.7 V)
  - ◆ JESD8-B (2.7 V to 3.6 V)
- ESD protection:
  - ◆ HBM JESD22-A114E Class 3A exceeds 5000 V
  - ◆ MM JESD22-A115-A exceeds 200 V
  - ◆ CDM JESD22-C101C exceeds 1000 V
- Low static power consumption;  $I_{CC} = 0.9 \mu\text{A}$  (maximum)
- Latch-up performance exceeds 100 mA per JESD 78 Class II
- Inputs accept voltages up to 3.6 V
- Low noise overshoot and undershoot < 10 % of  $V_{CC}$
- $I_{OFF}$  circuitry provides partial Power-down mode operation
- Multiple package options
- Specified from  $-40 \text{ }^\circ\text{C}$  to  $+85 \text{ }^\circ\text{C}$  and  $-40 \text{ }^\circ\text{C}$  to  $+125 \text{ }^\circ\text{C}$

### 3. Ordering information

**Table 1. Ordering information**

| Type number | Package           |       |   | Version |
|-------------|-------------------|-------|---|---------|
|             | Temperature range | Name  | Description   |         |
| 74AUP1G11GW | -40 °C to +125 °C | SC-88 | plastic surface-mounted package; 6 leads  | SOT363  |
| 74AUP1G11GM | -40 °C to +125 °C | XSON6 | plastic extremely thin small outline package; no leads; 6 terminals; body 1 × 1.45 × 0.5 mm | SOT886  |
| 74AUP1G11GF | -40 °C to +125 °C | XSON6 | plastic extremely thin small outline package; no leads; 6 terminals; body 1 × 1 × 0.5 mm    | SOT891  |

### 4. Marking

**Table 2. Marking**

| Type number | Marking code |
|-------------|--------------|
| 74AUP1G11GW | pU           |
| 74AUP1G11GM | pU           |
| 74AUP1G11GF | pU           |

### 5. Functional diagram

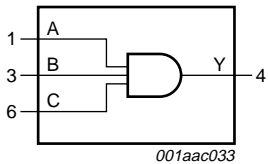
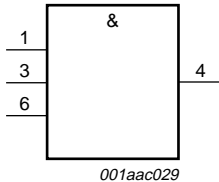
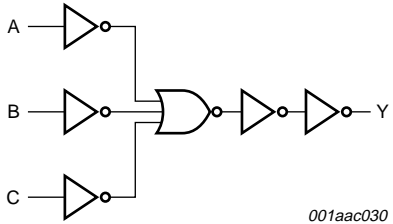
|   |   |  |
|---|---|--|
|  <p><b>Fig 1. Logic symbol</b></p> |  <p><b>Fig 2. IEC logic symbol</b></p> |  <p><b>Fig 3. Logic diagram</b></p> |
|---|---|--|

## 6. Pinning information

### 6.1 Pinning

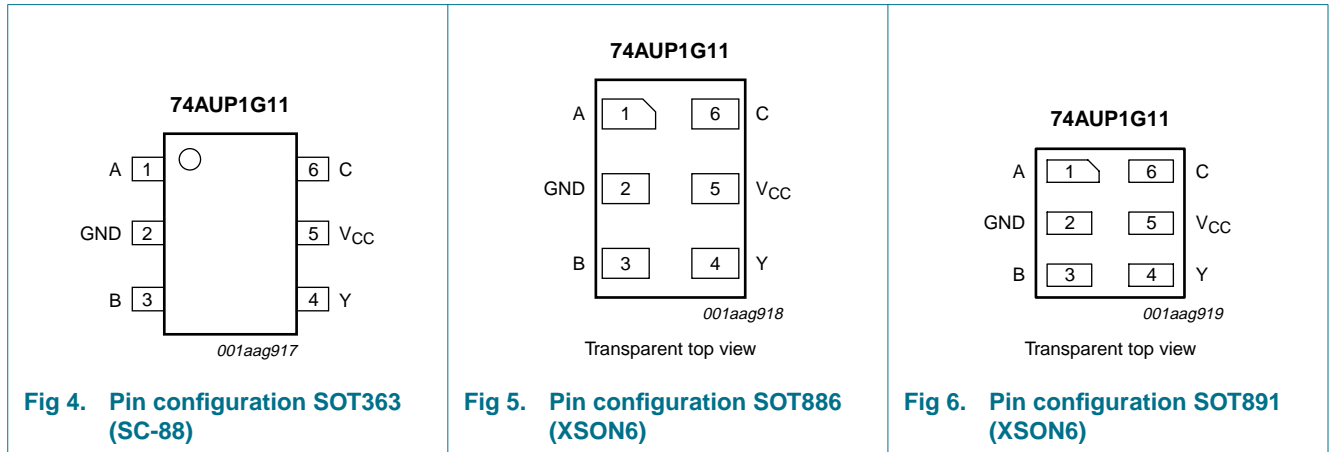

### 6.2 Pin description

**Table 3. Pin description**

| Symbol          | Pin | Description    |
|-----------------|-----|----------------|
| A               | 1   | data input     |
| GND             | 2   | ground (0 V)   |
| B               | 3   | data input     |
| Y               | 4   | data output    |
| V <sub>CC</sub> | 5   | supply voltage |
| C               | 6   | data input     |

## 7. Functional description

**Table 4. Function table<sup>[1]</sup>**

| Input |   |   | Output |
|-------|---|---|--------|
| A     | B | C | Y      |
| H     | H | H | H      |
| L     | X | X | L      |
| X     | L | X | L      |
| X     | X | L | L      |

[1] H = HIGH voltage level;  
L = LOW voltage level;  
X = don't care.

## 8. Limiting values

**Table 5. Limiting values**

In accordance with the Absolute Maximum Rating System (IEC 60134). Voltages are referenced to GND (ground = 0 V).

| Symbol    | Parameter               | Conditions                      | Min      | Max      | Unit |
|-----------|-------------------------|---------------------------------|----------|----------|------|
| $V_{CC}$  | supply voltage          |                                 | -0.5     | +4.6     | V    |
| $I_{IK}$  | input clamping current  | $V_I < 0$ V                     | -50      | -        | mA   |
| $V_I$     | input voltage           |                                 | [1] -0.5 | +4.6     | V    |
| $I_{OK}$  | output clamping current | $V_O > V_{CC}$ or $V_O < 0$ V   | -        | $\pm 50$ | mA   |
| $V_O$     | output voltage          | Active mode and Power-down mode | [1] -0.5 | +4.6     | V    |
| $I_O$     | output current          | $V_O = 0$ V to $V_{CC}$         | -        | $\pm 20$ | mA   |
| $I_{CC}$  | supply current          |                                 | -        | 50       | mA   |
| $I_{GND}$ | ground current          |                                 | -50      | -        | mA   |
| $T_{stg}$ | storage temperature     |                                 | -65      | +150     | °C   |
| $P_{tot}$ | total power dissipation | $T_{amb} = -40$ °C to +125 °C   | [2] -    | 250      | mW   |

[1] The minimum input and output voltage ratings may be exceeded if the input and output current ratings are observed.

[2] For SC-88 packages: above 87.5 °C the value of  $P_{tot}$  derates linearly with 4.0 mW/K.  
 For XSON6 packages: above 45 °C the value of  $P_{tot}$  derates linearly with 2.4 mW/K.

## 9. Recommended operating conditions

**Table 6. Recommended operating conditions**

| Symbol              | Parameter                           | Conditions                      | Min | Max      | Unit |
|---------------------|-------------------------------------|---------------------------------|-----|----------|------|
| $V_{CC}$            | supply voltage                      |                                 | 0.8 | 3.6      | V    |
| $V_I$               | input voltage                       |                                 | 0   | 3.6      | V    |
| $V_O$               | output voltage                      | Active mode                     | 0   | $V_{CC}$ | V    |
|                     |                                     | Power-down mode; $V_{CC} = 0$ V | 0   | 3.6      | V    |
| $T_{amb}$           | ambient temperature                 |                                 | -40 | +125     | °C   |
| $\Delta t/\Delta V$ | input transition rise and fall rate | $V_{CC} = 0.8$ V to 3.6 V       | -   | 200      | ns/V |

## 10. Static characteristics

**Table 7. Static characteristics**

At recommended operating conditions; voltages are referenced to GND (ground = 0 V).

| Symbol                         | Parameter                            | Conditions   | Min                    | Typ | Max                    | Unit |
|--------------------------------|--------------------------------------|--|------------------------|-----|------------------------|------|
| <b>T<sub>amb</sub> = 25 °C</b> |                                      |  |                        |     |                        |      |
| V <sub>IH</sub>                | HIGH-level input voltage             | V <sub>CC</sub> = 0.8 V  | 0.70 × V <sub>CC</sub> | -   | -                      | V    |
|                                |                                      | V <sub>CC</sub> = 0.9 V to 1.95 V  | 0.65 × V <sub>CC</sub> | -   | -                      | V    |
|                                |                                      | V <sub>CC</sub> = 2.3 V to 2.7 V   | 1.6                    | -   | -                      | V    |
|                                |                                      | V <sub>CC</sub> = 3.0 V to 3.6 V   | 2.0                    | -   | -                      | V    |
| V <sub>IL</sub>                | LOW-level input voltage              | V <sub>CC</sub> = 0.8 V  | -                      | -   | 0.30 × V <sub>CC</sub> | V    |
|                                |                                      | V <sub>CC</sub> = 0.9 V to 1.95 V  | -                      | -   | 0.35 × V <sub>CC</sub> | V    |
|                                |                                      | V <sub>CC</sub> = 2.3 V to 2.7 V   | -                      | -   | 0.7                    | V    |
|                                |                                      | V <sub>CC</sub> = 3.0 V to 3.6 V   | -                      | -   | 0.9                    | V    |
| V <sub>OH</sub>                | HIGH-level output voltage            | V <sub>I</sub> = V <sub>IH</sub> or V <sub>IL</sub>  |                        |     |                        |      |
|                                |                                      | I <sub>O</sub> = -20 μA; V <sub>CC</sub> = 0.8 V to 3.6 V  | V <sub>CC</sub> - 0.1  | -   | -                      | V    |
|                                |                                      | I <sub>O</sub> = -1.1 mA; V <sub>CC</sub> = 1.1 V  | 0.75 × V <sub>CC</sub> | -   | -                      | V    |
|                                |                                      | I <sub>O</sub> = -1.7 mA; V <sub>CC</sub> = 1.4 V  | 1.11                   | -   | -                      | V    |
|                                |                                      | I <sub>O</sub> = -1.9 mA; V <sub>CC</sub> = 1.65 V   | 1.32                   | -   | -                      | V    |
|                                |                                      | I <sub>O</sub> = -2.3 mA; V <sub>CC</sub> = 2.3 V  | 2.05                   | -   | -                      | V    |
|                                |                                      | I <sub>O</sub> = -3.1 mA; V <sub>CC</sub> = 2.3 V  | 1.9                    | -   | -                      | V    |
|                                |                                      | I <sub>O</sub> = -2.7 mA; V <sub>CC</sub> = 3.0 V  | 2.72                   | -   | -                      | V    |
| V <sub>OL</sub>                | LOW-level output voltage             | V <sub>I</sub> = V <sub>IH</sub> or V <sub>IL</sub>  |                        |     |                        |      |
|                                |                                      | I <sub>O</sub> = 20 μA; V <sub>CC</sub> = 0.8 V to 3.6 V   | -                      | -   | 0.1                    | V    |
|                                |                                      | I <sub>O</sub> = 1.1 mA; V <sub>CC</sub> = 1.1 V   | -                      | -   | 0.3 × V <sub>CC</sub>  | V    |
|                                |                                      | I <sub>O</sub> = 1.7 mA; V <sub>CC</sub> = 1.4 V   | -                      | -   | 0.31                   | V    |
|                                |                                      | I <sub>O</sub> = 1.9 mA; V <sub>CC</sub> = 1.65 V  | -                      | -   | 0.31                   | V    |
|                                |                                      | I <sub>O</sub> = 2.3 mA; V <sub>CC</sub> = 2.3 V   | -                      | -   | 0.31                   | V    |
|                                |                                      | I <sub>O</sub> = 3.1 mA; V <sub>CC</sub> = 2.3 V   | -                      | -   | 0.44                   | V    |
|                                |                                      | I <sub>O</sub> = 2.7 mA; V <sub>CC</sub> = 3.0 V   | -                      | -   | 0.31                   | V    |
| I <sub>I</sub>                 | input leakage current                | V <sub>I</sub> = GND to 3.6 V; V <sub>CC</sub> = 0 V to 3.6 V                                    | -                      | -   | ±0.1                   | μA   |
|                                |                                      | V <sub>I</sub> or V <sub>O</sub> = 0 V to 3.6 V; V <sub>CC</sub> = 0 V                           | -                      | -   | ±0.2                   | μA   |
| I <sub>OFF</sub>               | power-off leakage current            | V <sub>I</sub> or V <sub>O</sub> = 0 V to 3.6 V; V <sub>CC</sub> = 0 V                           | -                      | -   | ±0.2                   | μA   |
| ΔI <sub>OFF</sub>              | additional power-off leakage current | V <sub>I</sub> or V <sub>O</sub> = 0 V to 3.6 V; V <sub>CC</sub> = 0 V to 0.2 V                  | -                      | -   | ±0.2                   | μA   |
| I <sub>CC</sub>                | supply current                       | V <sub>I</sub> = GND or V <sub>CC</sub> ; I <sub>O</sub> = 0 A; V <sub>CC</sub> = 0.8 V to 3.6 V | -                      | -   | 0.5                    | μA   |
| ΔI <sub>CC</sub>               | additional supply current            | V <sub>I</sub> = V <sub>CC</sub> - 0.6 V; I <sub>O</sub> = 0 A; V <sub>CC</sub> = 3.3 V          | <a href="#">[1]</a>    | -   | 40                     | μA   |
| C <sub>I</sub>                 | input capacitance                    | V <sub>CC</sub> = 0 V to 3.6 V; V <sub>I</sub> = GND or V <sub>CC</sub>                          | -                      | 0.8 | -                      | pF   |
| C <sub>O</sub>                 | output capacitance                   | V <sub>O</sub> = GND; V <sub>CC</sub> = 0 V  | -                      | 1.7 | -                      | pF   |

**Table 7. Static characteristics ...continued**

At recommended operating conditions; voltages are referenced to GND (ground = 0 V).

| Symbol                                    | Parameter                 | Conditions  | Min  | Typ | Max                    | Unit |    |
|---|---------------------------|---|--|-----|------------------------|------|----|
| <b>T<sub>amb</sub> = -40 °C to +85 °C</b> |                           |   |  |     |                        |      |    |
| V <sub>IH</sub>                           | HIGH-level input voltage  | V <sub>CC</sub> = 0.8 V                                   | 0.70 × V <sub>CC</sub>   | -   | -                      | V    |    |
|   |                           | V <sub>CC</sub> = 0.9 V to 1.95 V                         | 0.65 × V <sub>CC</sub>   | -   | -                      | V    |    |
|   |                           | V <sub>CC</sub> = 2.3 V to 2.7 V                          | 1.6  | -   | -                      | V    |    |
|   |                           | V <sub>CC</sub> = 3.0 V to 3.6 V                          | 2.0  | -   | -                      | V    |    |
| V <sub>IL</sub>                           | LOW-level input voltage   | V <sub>CC</sub> = 0.8 V                                   | -  | -   | 0.30 × V <sub>CC</sub> | V    |    |
|   |                           | V <sub>CC</sub> = 0.9 V to 1.95 V                         | -  | -   | 0.35 × V <sub>CC</sub> | V    |    |
|   |                           | V <sub>CC</sub> = 2.3 V to 2.7 V                          | -  | -   | 0.7                    | V    |    |
|   |                           | V <sub>CC</sub> = 3.0 V to 3.6 V                          | -  | -   | 0.9                    | V    |    |
| V <sub>OH</sub>                           | HIGH-level output voltage | V <sub>I</sub> = V <sub>IH</sub> or V <sub>IL</sub>       |  |     |                        |      |    |
|   |                           | I <sub>O</sub> = -20 μA; V <sub>CC</sub> = 0.8 V to 3.6 V | V <sub>CC</sub> - 0.1  | -   | -                      | V    |    |
|   |                           | I <sub>O</sub> = -1.1 mA; V <sub>CC</sub> = 1.1 V         | 0.7 × V <sub>CC</sub>  | -   | -                      | V    |    |
|   |                           | I <sub>O</sub> = -1.7 mA; V <sub>CC</sub> = 1.4 V         | 1.03   | -   | -                      | V    |    |
|   |                           | I <sub>O</sub> = -1.9 mA; V <sub>CC</sub> = 1.65 V        | 1.30   | -   | -                      | V    |    |
|   |                           | I <sub>O</sub> = -2.3 mA; V <sub>CC</sub> = 2.3 V         | 1.97   | -   | -                      | V    |    |
|   |                           | I <sub>O</sub> = -3.1 mA; V <sub>CC</sub> = 2.3 V         | 1.85   | -   | -                      | V    |    |
|   |                           | I <sub>O</sub> = -2.7 mA; V <sub>CC</sub> = 3.0 V         | 2.67   | -   | -                      | V    |    |
| V <sub>OL</sub>                           | LOW-level output voltage  | V <sub>I</sub> = V <sub>IH</sub> or V <sub>IL</sub>       |  |     |                        |      |    |
|   |                           | I <sub>O</sub> = 20 μA; V <sub>CC</sub> = 0.8 V to 3.6 V  | -  | -   | 0.1                    | V    |    |
|   |                           | I <sub>O</sub> = 1.1 mA; V <sub>CC</sub> = 1.1 V          | -  | -   | 0.3 × V <sub>CC</sub>  | V    |    |
|   |                           | I <sub>O</sub> = 1.7 mA; V <sub>CC</sub> = 1.4 V          | -  | -   | 0.37                   | V    |    |
|   |                           | I <sub>O</sub> = 1.9 mA; V <sub>CC</sub> = 1.65 V         | -  | -   | 0.35                   | V    |    |
|   |                           | I <sub>O</sub> = 2.3 mA; V <sub>CC</sub> = 2.3 V          | -  | -   | 0.33                   | V    |    |
|   |                           | I <sub>O</sub> = 3.1 mA; V <sub>CC</sub> = 2.3 V          | -  | -   | 0.45                   | V    |    |
|   |                           | I <sub>O</sub> = 2.7 mA; V <sub>CC</sub> = 3.0 V          | -  | -   | 0.33                   | V    |    |
|   | I <sub>I</sub>            | input leakage current                                     | V <sub>I</sub> = GND to 3.6 V; V <sub>CC</sub> = 0 V to 3.6 V                                    | -   | -                      | ±0.5 | μA |
|   | I <sub>OFF</sub>          | power-off leakage current                                 | V <sub>I</sub> or V <sub>O</sub> = 0 V to 3.6 V; V <sub>CC</sub> = 0 V                           | -   | -                      | ±0.5 | μA |
|   | ΔI <sub>OFF</sub>         | additional power-off leakage current                      | V <sub>I</sub> or V <sub>O</sub> = 0 V to 3.6 V; V <sub>CC</sub> = 0 V to 0.2 V                  | -   | -                      | ±0.6 | μA |
|   | I <sub>CC</sub>           | supply current  | V <sub>I</sub> = GND or V <sub>CC</sub> ; I <sub>O</sub> = 0 A; V <sub>CC</sub> = 0.8 V to 3.6 V | -   | -                      | 0.9  | μA |
|   | ΔI <sub>CC</sub>          | additional supply current                                 | V <sub>I</sub> = V <sub>CC</sub> - 0.6 V; I <sub>O</sub> = 0 A; V <sub>CC</sub> = 3.3 V          | [1] | -                      | 50   | μA |

**Table 7. Static characteristics ...continued**

At recommended operating conditions; voltages are referenced to GND (ground = 0 V).

| Symbol                                     | Parameter                            | Conditions   | Min                    | Typ | Max                    | Unit |
|--|--------------------------------------|--|------------------------|-----|------------------------|------|
| <b>T<sub>amb</sub> = -40 °C to +125 °C</b> |                                      |  |                        |     |                        |      |
| V <sub>IH</sub>                            | HIGH-level input voltage             | V <sub>CC</sub> = 0.8 V  | 0.75 × V <sub>CC</sub> | -   | -                      | V    |
|  |                                      | V <sub>CC</sub> = 0.9 V to 1.95 V  | 0.70 × V <sub>CC</sub> | -   | -                      | V    |
|  |                                      | V <sub>CC</sub> = 2.3 V to 2.7 V   | 1.6                    | -   | -                      | V    |
|  |                                      | V <sub>CC</sub> = 3.0 V to 3.6 V   | 2.0                    | -   | -                      | V    |
| V <sub>IL</sub>                            | LOW-level input voltage              | V <sub>CC</sub> = 0.8 V  | -                      | -   | 0.25 × V <sub>CC</sub> | V    |
|  |                                      | V <sub>CC</sub> = 0.9 V to 1.95 V  | -                      | -   | 0.30 × V <sub>CC</sub> | V    |
|  |                                      | V <sub>CC</sub> = 2.3 V to 2.7 V   | -                      | -   | 0.7                    | V    |
|  |                                      | V <sub>CC</sub> = 3.0 V to 3.6 V   | -                      | -   | 0.9                    | V    |
| V <sub>OH</sub>                            | HIGH-level output voltage            | V <sub>I</sub> = V <sub>IH</sub> or V <sub>IL</sub>  |                        |     |                        |      |
|  |                                      | I <sub>O</sub> = -20 μA; V <sub>CC</sub> = 0.8 V to 3.6 V  | V <sub>CC</sub> - 0.11 | -   | -                      | V    |
|  |                                      | I <sub>O</sub> = -1.1 mA; V <sub>CC</sub> = 1.1 V  | 0.6 × V <sub>CC</sub>  | -   | -                      | V    |
|  |                                      | I <sub>O</sub> = -1.7 mA; V <sub>CC</sub> = 1.4 V  | 0.93                   | -   | -                      | V    |
|  |                                      | I <sub>O</sub> = -1.9 mA; V <sub>CC</sub> = 1.65 V   | 1.17                   | -   | -                      | V    |
|  |                                      | I <sub>O</sub> = -2.3 mA; V <sub>CC</sub> = 2.3 V  | 1.77                   | -   | -                      | V    |
|  |                                      | I <sub>O</sub> = -3.1 mA; V <sub>CC</sub> = 2.3 V  | 1.67                   | -   | -                      | V    |
|  |                                      | I <sub>O</sub> = -2.7 mA; V <sub>CC</sub> = 3.0 V  | 2.40                   | -   | -                      | V    |
| V <sub>OL</sub>                            | LOW-level output voltage             | V <sub>I</sub> = V <sub>IH</sub> or V <sub>IL</sub>  |                        |     |                        |      |
|  |                                      | I <sub>O</sub> = 20 μA; V <sub>CC</sub> = 0.8 V to 3.6 V   | -                      | -   | 0.11                   | V    |
|  |                                      | I <sub>O</sub> = 1.1 mA; V <sub>CC</sub> = 1.1 V   | -                      | -   | 0.33 × V <sub>CC</sub> | V    |
|  |                                      | I <sub>O</sub> = 1.7 mA; V <sub>CC</sub> = 1.4 V   | -                      | -   | 0.41                   | V    |
|  |                                      | I <sub>O</sub> = 1.9 mA; V <sub>CC</sub> = 1.65 V  | -                      | -   | 0.39                   | V    |
|  |                                      | I <sub>O</sub> = 2.3 mA; V <sub>CC</sub> = 2.3 V   | -                      | -   | 0.36                   | V    |
|  |                                      | I <sub>O</sub> = 3.1 mA; V <sub>CC</sub> = 2.3 V   | -                      | -   | 0.50                   | V    |
|  |                                      | I <sub>O</sub> = 2.7 mA; V <sub>CC</sub> = 3.0 V   | -                      | -   | 0.36                   | V    |
| I <sub>I</sub>                             | input leakage current                | V <sub>I</sub> = GND to 3.6 V; V <sub>CC</sub> = 0 V to 3.6 V                                    | -                      | -   | ±0.75                  | μA   |
| I <sub>OFF</sub>                           | power-off leakage current            | V <sub>I</sub> or V <sub>O</sub> = 0 V to 3.6 V; V <sub>CC</sub> = 0 V                           | -                      | -   | ±0.75                  | μA   |
| ΔI <sub>OFF</sub>                          | additional power-off leakage current | V <sub>I</sub> or V <sub>O</sub> = 0 V to 3.6 V; V <sub>CC</sub> = 0 V to 0.2 V                  | -                      | -   | ±0.75                  | μA   |
| I <sub>CC</sub>                            | supply current                       | V <sub>I</sub> = GND or V <sub>CC</sub> ; I <sub>O</sub> = 0 A; V <sub>CC</sub> = 0.8 V to 3.6 V | -                      | -   | 1.4                    | μA   |
| ΔI <sub>CC</sub>                           | additional supply current            | V <sub>I</sub> = V <sub>CC</sub> - 0.6 V; I <sub>O</sub> = 0 A; V <sub>CC</sub> = 3.3 V          | [1]                    | -   | 75                     | μA   |

[1] One input at V<sub>CC</sub> - 0.6 V, other input at V<sub>CC</sub> or GND.

## 11. Dynamic characteristics

**Table 8. Dynamic characteristics**

Voltages are referenced to GND (ground = 0 V); for test circuit see [Figure 8](#).

| Symbol                       | Parameter         | Conditions                                       | 25 °C |                    |      | -40 °C to +125 °C |             |              | Unit |
|------------------------------|-------------------|--|-------|--------------------|------|-------------------|-------------|--------------|------|
|                              |                   |  | Min   | Typ <sup>[1]</sup> | Max  | Min               | Max (85 °C) | Max (125 °C) |      |
| <b>C<sub>L</sub> = 5 pF</b>  |                   |  |       |                    |      |                   |             |              |      |
| t <sub>pd</sub>              | propagation delay | A, B and C to Y;<br>see <a href="#">Figure 7</a> |       |                    |      |                   |             |              |      |
|                              |                   | V <sub>CC</sub> = 0.8 V                          | -     | 18.9               | -    | -                 | -           | -            | ns   |
|                              |                   | V <sub>CC</sub> = 1.1 V to 1.3 V                 | 3.0   | 5.6                | 9.5  | 2.8               | 9.9         | 10.0         | ns   |
|                              |                   | V <sub>CC</sub> = 1.4 V to 1.6 V                 | 2.3   | 3.9                | 5.9  | 2.2               | 6.5         | 6.8          | ns   |
|                              |                   | V <sub>CC</sub> = 1.65 V to 1.95 V               | 1.9   | 3.1                | 4.8  | 1.8               | 5.3         | 5.5          | ns   |
|                              |                   | V <sub>CC</sub> = 2.3 V to 2.7 V                 | 1.6   | 2.5                | 3.6  | 1.4               | 4.0         | 4.2          | ns   |
|                              |                   | V <sub>CC</sub> = 3.0 V to 3.6 V                 | 1.3   | 2.2                | 3.2  | 1.2               | 3.5         | 3.7          | ns   |
| <b>C<sub>L</sub> = 10 pF</b> |                   |  |       |                    |      |                   |             |              |      |
| t <sub>pd</sub>              | propagation delay | A, B and C to Y;<br>see <a href="#">Figure 7</a> |       |                    |      |                   |             |              |      |
|                              |                   | V <sub>CC</sub> = 0.8 V                          | -     | 22.5               | -    | -                 | -           | -            | ns   |
|                              |                   | V <sub>CC</sub> = 1.1 V to 1.3 V                 | 3.5   | 6.5                | 11.1 | 3.3               | 11.6        | 11.8         | ns   |
|                              |                   | V <sub>CC</sub> = 1.4 V to 1.6 V                 | 2.8   | 4.5                | 6.8  | 2.6               | 7.5         | 7.8          | ns   |
|                              |                   | V <sub>CC</sub> = 1.65 V to 1.95 V               | 2.4   | 3.7                | 5.6  | 2.1               | 6.2         | 6.4          | ns   |
|                              |                   | V <sub>CC</sub> = 2.3 V to 2.7 V                 | 1.9   | 3.0                | 4.4  | 1.7               | 4.8         | 5.1          | ns   |
|                              |                   | V <sub>CC</sub> = 3.0 V to 3.6 V                 | 1.7   | 2.8                | 4.0  | 1.5               | 4.3         | 4.5          | ns   |
| <b>C<sub>L</sub> = 15 pF</b> |                   |  |       |                    |      |                   |             |              |      |
| t <sub>pd</sub>              | propagation delay | A, B and C to Y;<br>see <a href="#">Figure 7</a> |       |                    |      |                   |             |              |      |
|                              |                   | V <sub>CC</sub> = 0.8 V                          | -     | 23.6               | -    | -                 | -           | -            | ns   |
|                              |                   | V <sub>CC</sub> = 1.1 V to 1.3 V                 | 3.9   | 7.3                | 12.5 | 3.6               | 13.3        | 13.4         | ns   |
|                              |                   | V <sub>CC</sub> = 1.4 V to 1.6 V                 | 3.2   | 5.1                | 7.6  | 2.9               | 8.5         | 8.8          | ns   |
|                              |                   | V <sub>CC</sub> = 1.65 V to 1.95 V               | 2.7   | 4.2                | 6.3  | 2.4               | 6.9         | 7.3          | ns   |
|                              |                   | V <sub>CC</sub> = 2.3 V to 2.7 V                 | 2.3   | 3.5                | 5.0  | 2.0               | 5.5         | 5.8          | ns   |
|                              |                   | V <sub>CC</sub> = 3.0 V to 3.6 V                 | 2.0   | 3.2                | 4.6  | 1.8               | 5.0         | 5.2          | ns   |
| <b>C<sub>L</sub> = 30 pF</b> |                   |  |       |                    |      |                   |             |              |      |
| t <sub>pd</sub>              | propagation delay | A, B and C to Y;<br>see <a href="#">Figure 7</a> |       |                    |      |                   |             |              |      |
|                              |                   | V <sub>CC</sub> = 0.8 V                          | -     | 36.3               | -    | -                 | -           | -            | ns   |
|                              |                   | V <sub>CC</sub> = 1.1 V to 1.3 V                 | 5.1   | 9.5                | 16.8 | 4.8               | 17.9        | 18.3         | ns   |
|                              |                   | V <sub>CC</sub> = 1.4 V to 1.6 V                 | 4.2   | 6.7                | 10.0 | 3.8               | 11.3        | 11.8         | ns   |
|                              |                   | V <sub>CC</sub> = 1.65 V to 1.95 V               | 3.6   | 5.5                | 8.1  | 3.2               | 9.1         | 9.7          | ns   |
|                              |                   | V <sub>CC</sub> = 2.3 V to 2.7 V                 | 3.0   | 4.6                | 6.6  | 2.8               | 7.2         | 7.5          | ns   |
|                              |                   | V <sub>CC</sub> = 3.0 V to 3.6 V                 | 2.7   | 4.3                | 6.1  | 2.5               | 6.6         | 6.9          | ns   |

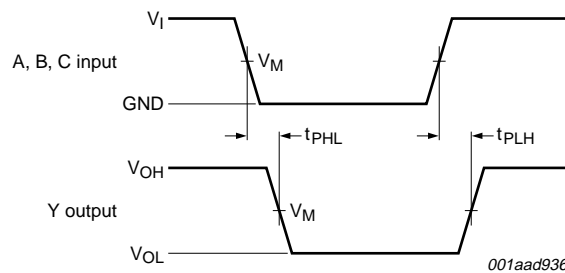

**Table 8. Dynamic characteristics ...continued**  
 Voltages are referenced to GND (ground = 0 V); for test circuit see [Figure 8](#).

| Symbol  | Parameter                     | Conditions   | 25 °C |                    |     | -40 °C to +125 °C |             |              | Unit |
|---|-------------------------------|--|-------|--------------------|-----|-------------------|-------------|--------------|------|
|   |                               |  | Min   | Typ <sup>[1]</sup> | Max | Min               | Max (85 °C) | Max (125 °C) |      |
| <b>C<sub>L</sub> = 5 pF, 10 pF, 15 pF and 30 pF</b> |                               |  |       |                    |     |                   |             |              |      |
| C <sub>PD</sub>                                     | power dissipation capacitance | f <sub>i</sub> = 1 MHz;<br>V <sub>I</sub> = GND to V <sub>CC</sub> |       |                    |     |                   |             |              |      |
|   |                               | V <sub>CC</sub> = 0.8 V  | -     | 2.7                | -   | -                 | -           | -            | pF   |
|   |                               | V <sub>CC</sub> = 1.1 V to 1.3 V                                   | -     | 2.8                | -   | -                 | -           | -            | pF   |
|   |                               | V <sub>CC</sub> = 1.4 V to 1.6 V                                   | -     | 2.9                | -   | -                 | -           | -            | pF   |
|   |                               | V <sub>CC</sub> = 1.65 V to 1.95 V                                 | -     | 3.1                | -   | -                 | -           | -            | pF   |
|   |                               | V <sub>CC</sub> = 2.3 V to 2.7 V                                   | -     | 3.5                | -   | -                 | -           | -            | pF   |
|   |                               | V <sub>CC</sub> = 3.0 V to 3.6 V                                   | -     | 4.1                | -   | -                 | -           | -            | pF   |

- [1] All typical values are measured at nominal V<sub>CC</sub>.
- [2] t<sub>pd</sub> is the same as t<sub>PLH</sub> and t<sub>PHL</sub>.
- [3] C<sub>PD</sub> is used to determine the dynamic power dissipation (P<sub>D</sub> in μW).  
 $P_D = C_{PD} \times V_{CC}^2 \times f_i \times N + \Sigma(C_L \times V_{CC}^2 \times f_o)$  where:  
 f<sub>i</sub> = input frequency in MHz;  
 f<sub>o</sub> = output frequency in MHz;  
 C<sub>L</sub> = load capacitance in pF;  
 V<sub>CC</sub> = supply voltage in V;  
 N = number of inputs switching;  
 $\Sigma(C_L \times V_{CC}^2 \times f_o)$  = sum of the outputs.

## 12. Waveforms



Measurement points are given in [Table 9](#).  
 Logic levels: V<sub>OL</sub> and V<sub>OH</sub> are typical output voltage drop that occur with the output load.

**Fig 7. Input A, B and C to output Y propagation delay times**

**Table 9. Measurement points**

| Supply voltage  | Output                | Input                 |                 |                                 |
|-----------------|-----------------------|-----------------------|-----------------|---------------------------------|
| V <sub>CC</sub> | V <sub>M</sub>        | V <sub>M</sub>        | V <sub>I</sub>  | t <sub>r</sub> = t <sub>f</sub> |
| 0.8 V to 3.6 V  | 0.5 × V <sub>CC</sub> | 0.5 × V <sub>CC</sub> | V <sub>CC</sub> | ≤ 3.0 ns                        |

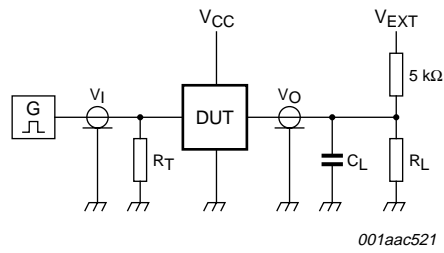

Test data is given in [Table 10](#).

Definitions for test circuit:

$R_L$  = Load resistance.

$C_L$  = Load capacitance including jig and probe capacitance.

$R_T$  = Termination resistance should be equal to the output impedance  $Z_o$  of the pulse generator.

$V_{EXT}$  = External voltage for measuring switching times.

**Fig 8. Load circuitry for switching times**

**Table 10. Test data**

| Supply voltage | Load                         |              | $V_{EXT}$             |                       |                       |
|----------------|------------------------------|--------------|-----------------------|-----------------------|-----------------------|
| $V_{CC}$       | $C_L$                        | $R_L$ [1]    | $t_{PLH}$ , $t_{PHL}$ | $t_{PZH}$ , $t_{PHZ}$ | $t_{PZL}$ , $t_{PLZ}$ |
| 0.8 V to 3.6 V | 5 pF, 10 pF, 15 pF and 30 pF | 5 kΩ or 1 MΩ | open                  | GND                   | $2 \times V_{CC}$     |

[1] For measuring enable and disable times  $R_L = 5 \text{ k}\Omega$ , for measuring propagation delays, setup and hold times and pulse width  $R_L = 1 \text{ M}\Omega$ .

13. Package outline

Plastic surface-mounted package; 6 leads

SOT363

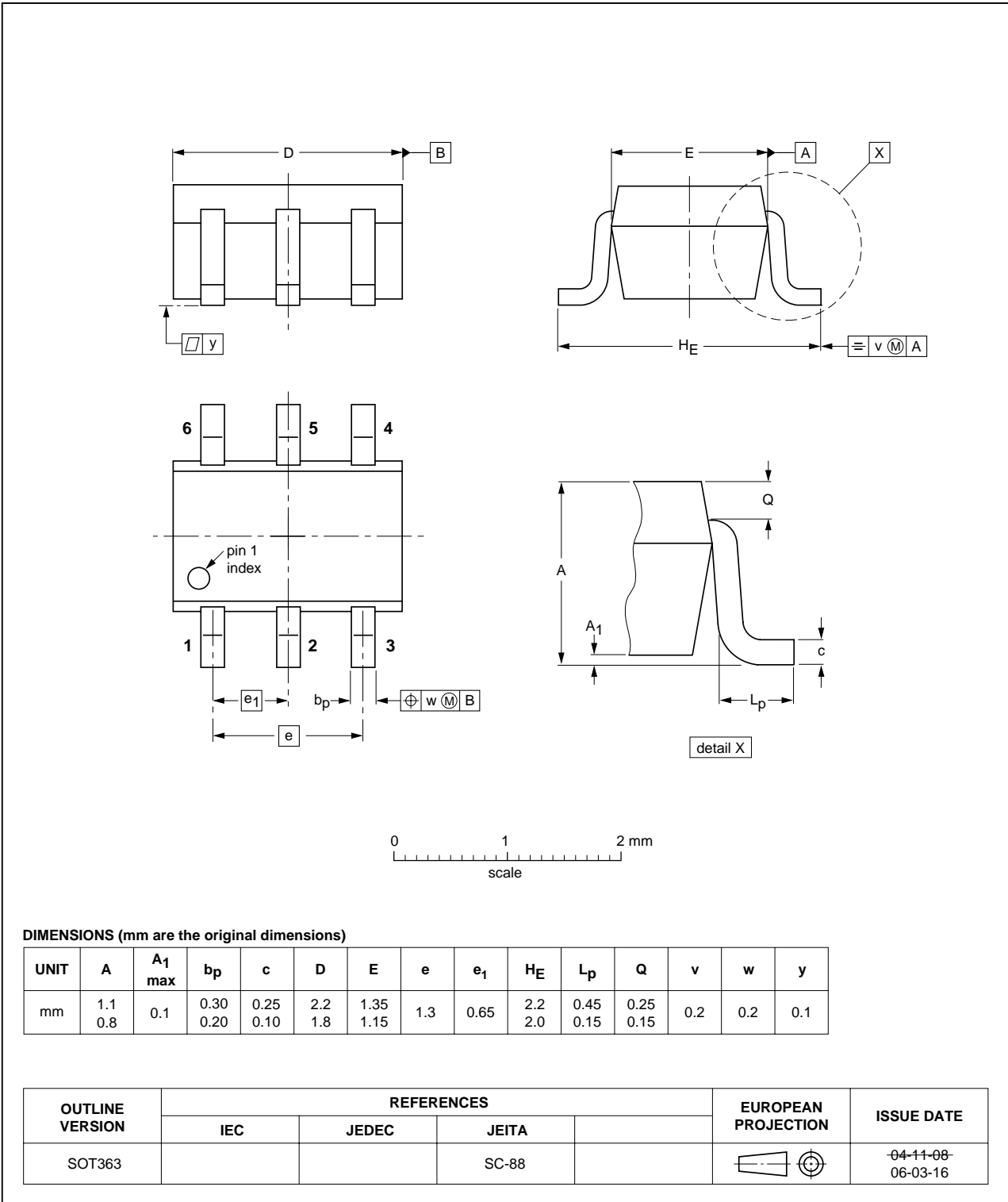

Fig 9. Package outline SOT363 (SC-88)

XSON6: plastic extremely thin small outline package; no leads; 6 terminals; body 1 x 1.45 x 0.5 mm

SOT886



Fig 10. Package outline SOT886 (XSON6)

XSON6: plastic extremely thin small outline package; no leads; 6 terminals; body 1 x 1 x 0.5 mm

SOT891

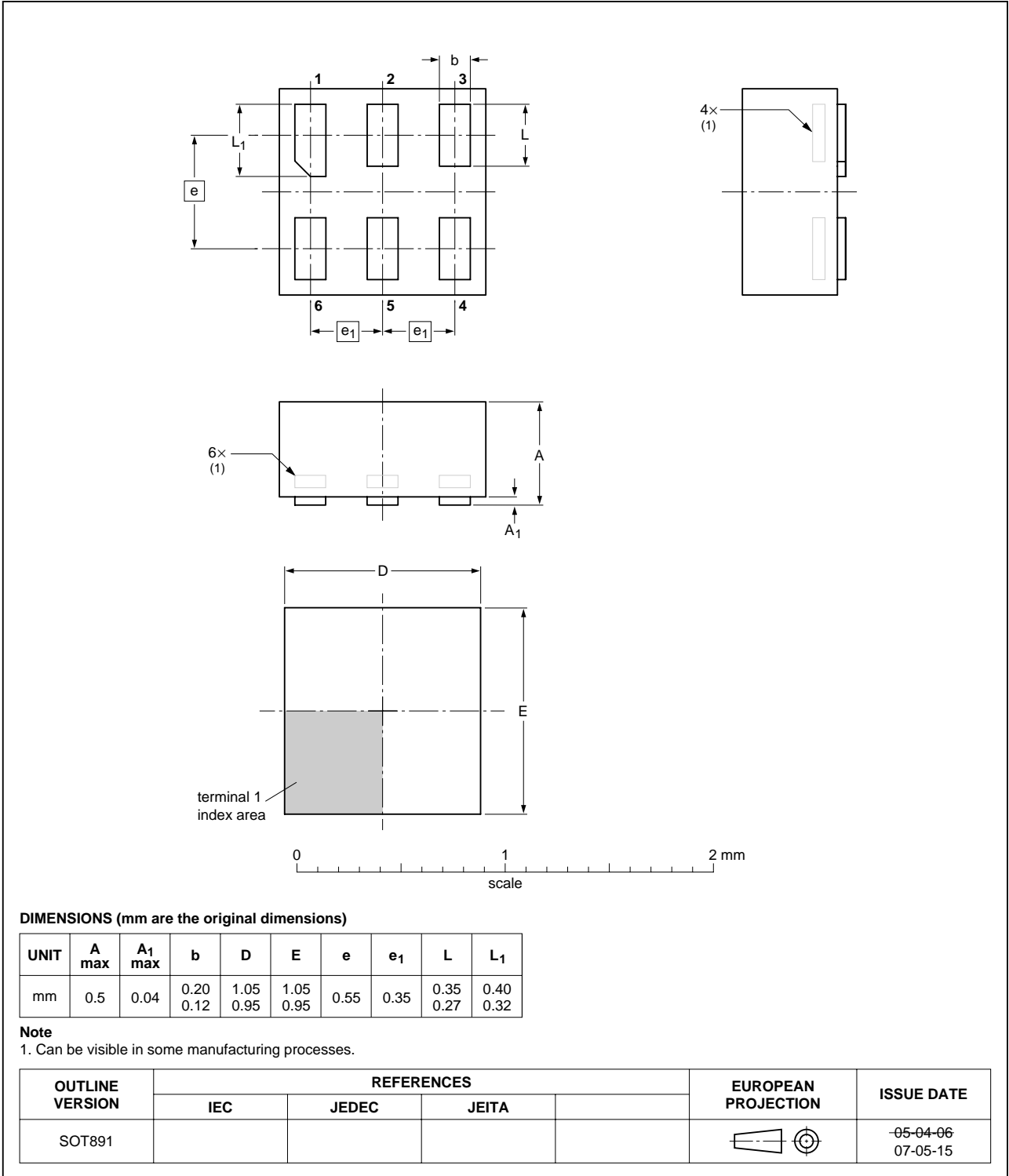

Fig 11. Package outline SOT891 (XSON6)

## 14. Abbreviations

Table 11. Abbreviations

| Acronym | Description                             |
|---------|---|
| CDM     | Charged Device Model                    |
| CMOS    | Complementary Metal Oxide Semiconductor |
| DUT     | Device Under Test                       |
| ESD     | ElectroStatic Discharge                 |
| HBM     | Human Body Model                        |
| MM      | Machine Model                           |

## 15. Revision history

Table 12. Revision history

| Document ID | Release date | Data sheet status  | Change notice | Supersedes |
|-------------|--------------|--------------------|---------------|------------|
| 74AUP1G11_1 | 20070904     | Product data sheet | -             | -          |

## 16. Legal information

### 16.1 Data sheet status

| Document status <sup>[1][2]</sup> | Product status <sup>[3]</sup> | Definition  |
|-----------------------------------|-------------------------------|---|
| Objective [short] data sheet      | Development                   | This document contains data from the objective specification for product development. |
| Preliminary [short] data sheet    | Qualification                 | This document contains data from the preliminary specification.                       |
| Product [short] data sheet        | Production                    | This document contains the product specification.                                     |

[1] Please consult the most recently issued document before initiating or completing a design.

[2] The term 'short data sheet' is explained in section "Definitions".

[3] The product status of device(s) described in this document may have changed since this document was published and may differ in case of multiple devices. The latest product status information is available on the Internet at URL <http://www.nxp.com>.

### 16.2 Definitions

**Draft** — The document is a draft version only. The content is still under internal review and subject to formal approval, which may result in modifications or additions. NXP Semiconductors does not give any representations or warranties as to the accuracy or completeness of information included herein and shall have no liability for the consequences of use of such information.

**Short data sheet** — A short data sheet is an extract from a full data sheet with the same product type number(s) and title. A short data sheet is intended for quick reference only and should not be relied upon to contain detailed and full information. For detailed and full information see the relevant full data sheet, which is available on request via the local NXP Semiconductors sales office. In case of any inconsistency or conflict with the short data sheet, the full data sheet shall prevail.

### 16.3 Disclaimers

**General** — Information in this document is believed to be accurate and reliable. However, NXP Semiconductors does not give any representations or warranties, expressed or implied, as to the accuracy or completeness of such information and shall have no liability for the consequences of use of such information.

**Right to make changes** — NXP Semiconductors reserves the right to make changes to information published in this document, including without limitation specifications and product descriptions, at any time and without notice. This document supersedes and replaces all information supplied prior to the publication hereof.

**Suitability for use** — NXP Semiconductors products are not designed, authorized or warranted to be suitable for use in medical, military, aircraft, space or life support equipment, nor in applications where failure or

malfunction of a NXP Semiconductors product can reasonably be expected to result in personal injury, death or severe property or environmental damage. NXP Semiconductors accepts no liability for inclusion and/or use of NXP Semiconductors products in such equipment or applications and therefore such inclusion and/or use is at the customer's own risk.

**Applications** — Applications that are described herein for any of these products are for illustrative purposes only. NXP Semiconductors makes no representation or warranty that such applications will be suitable for the specified use without further testing or modification.

**Limiting values** — Stress above one or more limiting values (as defined in the Absolute Maximum Ratings System of IEC 60134) may cause permanent damage to the device. Limiting values are stress ratings only and operation of the device at these or any other conditions above those given in the Characteristics sections of this document is not implied. Exposure to limiting values for extended periods may affect device reliability.

**Terms and conditions of sale** — NXP Semiconductors products are sold subject to the general terms and conditions of commercial sale, as published at <http://www.nxp.com/profile/terms>, including those pertaining to warranty, intellectual property rights infringement and limitation of liability, unless explicitly otherwise agreed to in writing by NXP Semiconductors. In case of any inconsistency or conflict between information in this document and such terms and conditions, the latter will prevail.

**No offer to sell or license** — Nothing in this document may be interpreted or construed as an offer to sell products that is open for acceptance or the grant, conveyance or implication of any license under any copyrights, patents or other industrial or intellectual property rights.

### 16.4 Trademarks

Notice: All referenced brands, product names, service names and trademarks are the property of their respective owners.

## 17. Contact information

For additional information, please visit: <http://www.nxp.com>

For sales office addresses, send an email to: [salesaddresses@nxp.com](mailto:salesaddresses@nxp.com)

**18. Contents**

1 **General description** ..... 1

2 **Features** ..... 1

3 **Ordering information** ..... 2

4 **Marking** ..... 2

5 **Functional diagram** ..... 2

6 **Pinning information** ..... 3

6.1 Pinning ..... 3

6.2 Pin description ..... 3

7 **Functional description** ..... 3

8 **Limiting values** ..... 4

9 **Recommended operating conditions** ..... 4

10 **Static characteristics** ..... 5

11 **Dynamic characteristics** ..... 8

12 **Waveforms** ..... 9

13 **Package outline** ..... 11

14 **Abbreviations** ..... 14

15 **Revision history** ..... 14

16 **Legal information** ..... 15

16.1 Data sheet status ..... 15

16.2 Definitions ..... 15

16.3 Disclaimers ..... 15

16.4 Trademarks ..... 15

17 **Contact information** ..... 15

18 **Contents** ..... 16

Please be aware that important notices concerning this document and the product(s) described herein, have been included in section 'Legal information'.



© NXP B.V. 2007.

All rights reserved.

For more information, please visit: <http://www.nxp.com>

For sales office addresses, please send an email to: [salesaddresses@nxp.com](mailto:salesaddresses@nxp.com)

Date of release: 4 September 2007

Document identifier: 74AUP1G11\_1