

# 74AUP2G241

Low-power dual buffer/line driver; 3-state

Rev. 03 — 12 January 2009

Product data sheet

## 1. General description

The 74AUP2G241 provides a dual non-inverting buffer/line driver with 3-state outputs. The 3-state outputs are controlled by the output enable inputs  $1\overline{OE}$  and 2OE. A HIGH level at pin  $1\overline{OE}$  causes output 1Y to assume a high-impedance OFF-state. A LOW level at pin 2OE causes output 2Y to assume a high-impedance OFF-state.

Schmitt trigger action at all inputs makes the circuit tolerant to slower input rise and fall times across the entire  $V_{CC}$  range from 0.8 V to 3.6 V.

This device ensures a very low static and dynamic power consumption across the entire  $V_{CC}$  range from 0.8 V to 3.6 V.

This device is fully specified for partial power-down applications using  $I_{OFF}$ . The  $I_{OFF}$  circuitry disables the output, preventing the damaging backflow current through the device when it is powered down.

This device has an input-disable feature, which allows floating input signals. The input 1A is disabled when the output enable input  $1\overline{OE}$  is HIGH. The input 2A is disabled when the output enable input 2OE is LOW.

## 2. Features

- Wide supply voltage range from 0.8 V to 3.6 V
- High noise immunity
- Complies with JEDEC standards:
  - ◆ JESD8-12 (0.8 V to 1.3 V)
  - ◆ JESD8-11 (0.9 V to 1.65 V)
  - ◆ JESD8-7 (1.2 V to 1.95 V)
  - ◆ JESD8-5 (1.8 V to 2.7 V)
  - ◆ JESD8-B (2.7 V to 3.6 V)
- ESD protection:
  - ◆ HBM JESD22-A114E Class 3A exceeds 5000 V
  - ◆ MM JESD22-A115-A exceeds 200 V
  - ◆ CDM JESD22-C101C exceeds 1000 V
- Low static power consumption;  $I_{CC} = 0.9 \mu\text{A}$  (maximum)
- Latch-up performance exceeds 100 mA per JESD 78 Class II
- Inputs accept voltages up to 3.6 V
- Low noise overshoot and undershoot  $< 10\%$  of  $V_{CC}$
- Input-disable feature allows floating input conditions
- $I_{OFF}$  circuitry provides partial Power-down mode operation

- Multiple package options
- Specified from  $-40\text{ }^{\circ}\text{C}$  to  $+85\text{ }^{\circ}\text{C}$  and  $-40\text{ }^{\circ}\text{C}$  to  $+125\text{ }^{\circ}\text{C}$

### 3. Ordering information

Table 1. Ordering information

Type number	Package			Version
	Temperature range	Name	Description	
74AUP2G241DC	$-40\text{ }^{\circ}\text{C}$ to $+125\text{ }^{\circ}\text{C}$	VSSOP8	plastic very thin shrink small outline package; 8 leads; body width 2.3 mm	SOT765-1
74AUP2G241GT	$-40\text{ }^{\circ}\text{C}$ to $+125\text{ }^{\circ}\text{C}$	XSON8	plastic extremely thin small outline package; no leads; 8 terminals; body $1 \times 1.95 \times 0.5\text{ mm}$	SOT833-1
74AUP2G241GD	$-40\text{ }^{\circ}\text{C}$ to $+125\text{ }^{\circ}\text{C}$	XSON8U	plastic extremely thin small outline package; no leads; 8 terminals; UTLP based; body $3 \times 2 \times 0.5\text{ mm}$	SOT996-2
74AUP2G241GM	$-40\text{ }^{\circ}\text{C}$ to $+125\text{ }^{\circ}\text{C}$	XQFN8U	plastic extremely thin quad flat package; no leads; 8 terminals; UTLP based; body $1.6 \times 1.6 \times 0.5\text{ mm}$	SOT902-1

### 4. Marking

Table 2. Marking codes

Type number	Marking code
74AUP2G241DC	p41
74AUP2G241GT	p41
74AUP2G241GD	p41
74AUP2G241GM	p41

### 5. Functional diagram

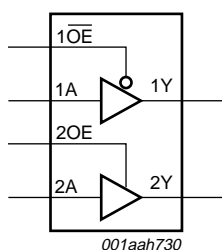

Fig 1. Logic symbol

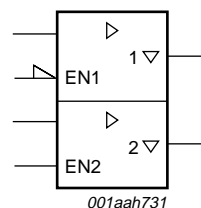

Fig 2. IEC logic symbol

## 6. Pinning information

### 6.1 Pinning

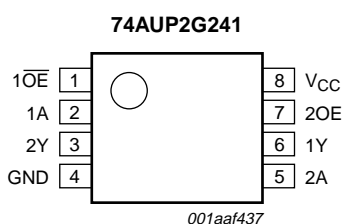

Fig 3. Pin configuration SOT765-1 (VSSOP8)

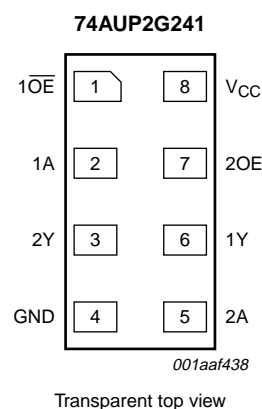

Fig 4. Pin configuration SOT833-1 (XSON8)

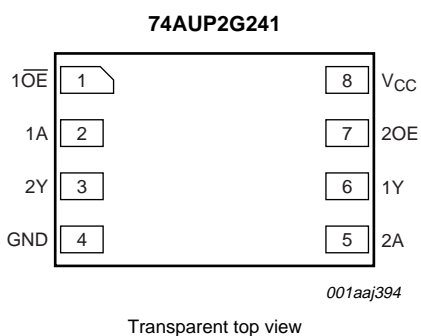

Fig 5. Pin configuration SOT996-2 (XSON8U)

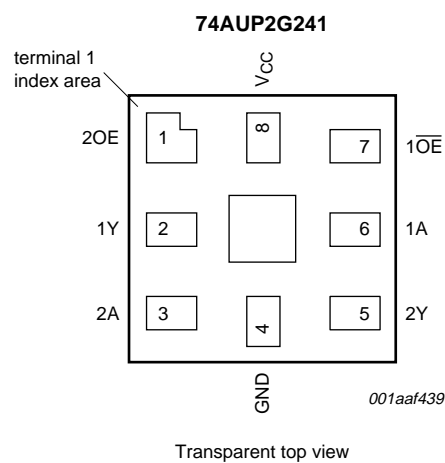

Fig 6. Pin configuration SOT902-1 (XQFN8U)

### 6.2 Pin description

Table 3. Pin description

Symbol	Pin		Description
	SOT765-1, SOT833-1 and SOT996-2	SOT902-1	
1OE	1	7	output enable input 1OE (active LOW)
1A, 2A	2, 5	6, 3	data input
1Y, 2Y	6, 3	2, 5	data output
GND	4	4	ground (0 V)
2OE	7	1	output enable input 2OE (active HIGH)
VCC	8	8	supply voltage

## 7. Functional description

Table 4. Function table<sup>[1]</sup>

Input		Output	Input		Output
1OE	1A	1Y	2OE	2A	2Y
L	L	L	H	L	L
L	H	H	H	H	H
H	X	Z	L	X	Z

[1] H = HIGH voltage level; L = LOW voltage level; X = don't care; Z = high-impedance OFF-state.

## 8. Limiting values

Table 5. Limiting values

In accordance with the Absolute Maximum Rating System (IEC 60134). Voltages are referenced to GND (ground = 0 V).

Symbol	Parameter	Conditions	Min	Max	Unit
$V_{CC}$	supply voltage		-0.5	+4.6	V
$I_{IK}$	input clamping current	$V_I < 0$ V	-50	-	mA
$V_I$	input voltage		[1] -0.5	+4.6	V
$I_{OK}$	output clamping current	$V_O < 0$ V	-50	-	mA
$V_O$	output voltage	Active mode and Power-down mode	[1] -0.5	+4.6	V
$I_O$	output current	$V_O = 0$ V to $V_{CC}$	-	±20	mA
$I_{CC}$	supply current		-	+50	mA
$I_{GND}$	ground current		-50	-	mA
$T_{stg}$	storage temperature		-65	+150	°C
$P_{tot}$	total power dissipation	$T_{amb} = -40$ °C to +125 °C	[2] -	250	mW

[1] The minimum input and output voltage ratings may be exceeded if the input and output current ratings are observed.

[2] For VSSOP8 packages: above 110 °C the value of  $P_{tot}$  derates linearly with 8.0 mW/K.

For XSON8, XSON8U and XQFN8U packages: above 45 °C the value of  $P_{tot}$  derates linearly with 2.4 mW/K.

## 9. Recommended operating conditions

Table 6. Operating conditions

Symbol	Parameter	Conditions	Min	Max	Unit
$V_{CC}$	supply voltage		0.8	3.6	V
$V_I$	input voltage		0	3.6	V
$V_O$	output voltage	Active mode	0	$V_{CC}$	V
		Power-down mode; $V_{CC} = 0$ V	0	3.6	V
$T_{amb}$	ambient temperature		-40	+125	°C
$\Delta t/\Delta V$	input transition rise and fall rate	$V_{CC} = 0.8$ V to 3.6 V	0	200	ns/V

## 10. Static characteristics

**Table 7. Static characteristics**

At recommended operating conditions; voltages are referenced to GND (ground = 0 V).

Symbol	Parameter	Conditions	Min	Typ	Max	Unit
<b>T<sub>amb</sub> = 25 °C</b>						
V <sub>IH</sub>	HIGH-level input voltage	V <sub>CC</sub> = 0.8 V	0.70 × V <sub>CC</sub>	-	-	V
		V <sub>CC</sub> = 0.9 V to 1.95 V	0.65 × V <sub>CC</sub>	-	-	V
		V <sub>CC</sub> = 2.3 V to 2.7 V	1.6	-	-	V
		V <sub>CC</sub> = 3.0 V to 3.6 V	2.0	-	-	V
V <sub>IL</sub>	LOW-level input voltage	V <sub>CC</sub> = 0.8 V	-	-	0.30 × V <sub>CC</sub>	V
		V <sub>CC</sub> = 0.9 V to 1.95 V	-	-	0.35 × V <sub>CC</sub>	V
		V <sub>CC</sub> = 2.3 V to 2.7 V	-	-	0.7	V
		V <sub>CC</sub> = 3.0 V to 3.6 V	-	-	0.9	V
V <sub>OH</sub>	HIGH-level output voltage	V <sub>I</sub> = V <sub>IH</sub> or V <sub>IL</sub>				
		I <sub>O</sub> = -20 μA; V <sub>CC</sub> = 0.8 V to 3.6 V	V <sub>CC</sub> - 0.1	-	-	V
		I <sub>O</sub> = -1.1 mA; V <sub>CC</sub> = 1.1 V	0.75 × V <sub>CC</sub>	-	-	V
		I <sub>O</sub> = -1.7 mA; V <sub>CC</sub> = 1.4 V	1.11	-	-	V
		I <sub>O</sub> = -1.9 mA; V <sub>CC</sub> = 1.65 V	1.32	-	-	V
		I <sub>O</sub> = -2.3 mA; V <sub>CC</sub> = 2.3 V	2.05	-	-	V
		I <sub>O</sub> = -3.1 mA; V <sub>CC</sub> = 2.3 V	1.9	-	-	V
		I <sub>O</sub> = -2.7 mA; V <sub>CC</sub> = 3.0 V	2.72	-	-	V
		I <sub>O</sub> = -4.0 mA; V <sub>CC</sub> = 3.0 V	2.6	-	-	V
V <sub>OL</sub>	LOW-level output voltage	V <sub>I</sub> = V <sub>IH</sub> or V <sub>IL</sub>				
		I <sub>O</sub> = 20 μA; V <sub>CC</sub> = 0.8 V to 3.6 V	-	-	0.1	V
		I <sub>O</sub> = 1.1 mA; V <sub>CC</sub> = 1.1 V	-	-	0.3 × V <sub>CC</sub>	V
		I <sub>O</sub> = 1.7 mA; V <sub>CC</sub> = 1.4 V	-	-	0.31	V
		I <sub>O</sub> = 1.9 mA; V <sub>CC</sub> = 1.65 V	-	-	0.31	V
		I <sub>O</sub> = 2.3 mA; V <sub>CC</sub> = 2.3 V	-	-	0.31	V
		I <sub>O</sub> = 3.1 mA; V <sub>CC</sub> = 2.3 V	-	-	0.44	V
		I <sub>O</sub> = 2.7 mA; V <sub>CC</sub> = 3.0 V	-	-	0.31	V
		I <sub>O</sub> = 4.0 mA; V <sub>CC</sub> = 3.0 V	-	-	0.44	V
I <sub>I</sub>	input leakage current	V <sub>I</sub> = GND to 3.6 V; V <sub>CC</sub> = 0 V to 3.6 V	-	-	±0.1	μA
I <sub>OZ</sub>	OFF-state output current	V <sub>I</sub> = V <sub>IH</sub> or V <sub>IL</sub> ; V <sub>O</sub> = 0 V to 3.6 V; V <sub>CC</sub> = 0 V to 3.6 V	-	-	±0.1	μA
I <sub>OFF</sub>	power-off leakage current	V <sub>I</sub> or V <sub>O</sub> = 0 V to 3.6 V; V <sub>CC</sub> = 0 V	-	-	±0.2	μA
ΔI <sub>OFF</sub>	additional power-off leakage current	V <sub>I</sub> or V <sub>O</sub> = 0 V to 3.6 V; V <sub>CC</sub> = 0 V to 0.2 V	-	-	±0.2	μA
I <sub>CC</sub>	supply current	V <sub>I</sub> = GND or V <sub>CC</sub> ; I <sub>O</sub> = 0 A; V <sub>CC</sub> = 0.8 V to 3.6 V	-	-	0.5	μA

**Table 7. Static characteristics ...continued**

At recommended operating conditions; voltages are referenced to GND (ground = 0 V).

Symbol	Parameter	Conditions	Min	Typ	Max	Unit
$\Delta I_{CC}$	additional supply current	data input; $V_I = V_{CC} - 0.6$ V; $I_O = 0$ A; $V_{CC} = 3.3$ V	[1]	-	40	$\mu$ A
		$1\overline{OE}$ and $2OE$ input; $V_I = V_{CC} - 0.6$ V; $I_O = 0$ A; $V_{CC} = 3.3$ V	[1]	-	110	$\mu$ A
		all inputs; $V_I =$ GND to 3.6 V; $1OE = V_{CC}$ ; $2OE =$ GND; $V_{CC} = 0.8$ V to 3.6 V	[2]	-	1	$\mu$ A
$C_I$	input capacitance	$V_{CC} = 0$ V to 3.6 V; $V_I =$ GND or $V_{CC}$	-	0.6	-	pF
$C_O$	output capacitance	output enabled; $V_O =$ GND; $V_{CC} = 0$ V	-	1.7	-	pF
		output disabled; $V_{CC} = 0$ V to 3.6 V; $V_O =$ GND or $V_{CC}$	-	1.5	-	pF
<b><math>T_{amb} = -40</math> °C to <math>+85</math> °C</b>						
$V_{IH}$	HIGH-level input voltage	$V_{CC} = 0.8$ V	$0.70 \times V_{CC}$	-	-	V
		$V_{CC} = 0.9$ V to 1.95 V	$0.65 \times V_{CC}$	-	-	V
		$V_{CC} = 2.3$ V to 2.7 V	1.6	-	-	V
		$V_{CC} = 3.0$ V to 3.6 V	2.0	-	-	V
$V_{IL}$	LOW-level input voltage	$V_{CC} = 0.8$ V	-	-	$0.30 \times V_{CC}$	V
		$V_{CC} = 0.9$ V to 1.95 V	-	-	$0.35 \times V_{CC}$	V
		$V_{CC} = 2.3$ V to 2.7 V	-	-	0.7	V
		$V_{CC} = 3.0$ V to 3.6 V	-	-	0.9	V
$V_{OH}$	HIGH-level output voltage	$V_I = V_{IH}$ or $V_{IL}$				
		$I_O = -20$ $\mu$ A; $V_{CC} = 0.8$ V to 3.6 V	$V_{CC} - 0.1$	-	-	V
		$I_O = -1.1$ mA; $V_{CC} = 1.1$ V	$0.7 \times V_{CC}$	-	-	V
		$I_O = -1.7$ mA; $V_{CC} = 1.4$ V	1.03	-	-	V
		$I_O = -1.9$ mA; $V_{CC} = 1.65$ V	1.30	-	-	V
		$I_O = -2.3$ mA; $V_{CC} = 2.3$ V	1.97	-	-	V
		$I_O = -3.1$ mA; $V_{CC} = 2.3$ V	1.85	-	-	V
		$I_O = -2.7$ mA; $V_{CC} = 3.0$ V	2.67	-	-	V
$V_{OL}$	LOW-level output voltage	$V_I = V_{IH}$ or $V_{IL}$				
		$I_O = 20$ $\mu$ A; $V_{CC} = 0.8$ V to 3.6 V	-	-	0.1	V
		$I_O = 1.1$ mA; $V_{CC} = 1.1$ V	-	-	$0.3 \times V_{CC}$	V
		$I_O = 1.7$ mA; $V_{CC} = 1.4$ V	-	-	0.37	V
		$I_O = 1.9$ mA; $V_{CC} = 1.65$ V	-	-	0.35	V
		$I_O = 2.3$ mA; $V_{CC} = 2.3$ V	-	-	0.33	V
		$I_O = 3.1$ mA; $V_{CC} = 2.3$ V	-	-	0.45	V
		$I_O = 2.7$ mA; $V_{CC} = 3.0$ V	-	-	0.33	V
$I_I$	input leakage current	$V_I =$ GND to 3.6 V; $V_{CC} = 0$ V to 3.6 V	-	-	$\pm 0.5$	$\mu$ A
		$V_I$ or $V_O = 0$ V to 3.6 V; $V_{CC} = 0$ V	-	-	$\pm 0.5$	$\mu$ A
$I_{OFF}$	power-off leakage current	$V_I$ or $V_O = 0$ V to 3.6 V; $V_{CC} = 0$ V	-	-	$\pm 0.5$	$\mu$ A
$I_{OZ}$	OFF-state output current	$V_I = V_{IH}$ or $V_{IL}$ ; $V_O = 0$ V to 3.6 V; $V_{CC} = 0$ V to 3.6 V	-	-	$\pm 0.5$	$\mu$ A

**Table 7. Static characteristics ...continued**

At recommended operating conditions; voltages are referenced to GND (ground = 0 V).

Symbol	Parameter	Conditions	Min	Typ	Max	Unit
$\Delta I_{OFF}$	additional power-off leakage current	$V_I$ or $V_O = 0$ V to 3.6 V; $V_{CC} = 0$ V to 0.2 V	-	-	$\pm 0.6$	$\mu$ A
$I_{CC}$	supply current	$V_I = \text{GND}$ or $V_{CC}$ ; $I_O = 0$ A; $V_{CC} = 0.8$ V to 3.6 V	-	-	0.9	$\mu$ A
$\Delta I_{CC}$	additional supply current	data input; $V_I = V_{CC} - 0.6$ V; $I_O = 0$ A; $V_{CC} = 3.3$ V	[1]	-	50	$\mu$ A
		$\overline{1OE}$ and $2OE$ input; $V_I = V_{CC} - 0.6$ V; $I_O = 0$ A; $V_{CC} = 3.3$ V	[1]	-	120	$\mu$ A
		all inputs; $V_I = \text{GND}$ to 3.6 V; $\overline{1OE} = V_{CC}$ ; $2OE = \text{GND}$ ; $V_{CC} = 0.8$ V to 3.6 V	[2]	-	1	$\mu$ A
<b><math>T_{amb} = -40</math> °C to <math>+125</math> °C</b>						
$V_{IH}$	HIGH-level input voltage	$V_{CC} = 0.8$ V	$0.75 \times V_{CC}$	-	-	V
		$V_{CC} = 0.9$ V to 1.95 V	$0.70 \times V_{CC}$	-	-	V
		$V_{CC} = 2.3$ V to 2.7 V	1.6	-	-	V
		$V_{CC} = 3.0$ V to 3.6 V	2.0	-	-	V
$V_{IL}$	LOW-level input voltage	$V_{CC} = 0.8$ V	-	-	$0.25 \times V_{CC}$	V
		$V_{CC} = 0.9$ V to 1.95 V	-	-	$0.30 \times V_{CC}$	V
		$V_{CC} = 2.3$ V to 2.7 V	-	-	0.7	V
		$V_{CC} = 3.0$ V to 3.6 V	-	-	0.9	V
$V_{OH}$	HIGH-level output voltage	$V_I = V_{IH}$ or $V_{IL}$				
		$I_O = -20$ $\mu$ A; $V_{CC} = 0.8$ V to 3.6 V	$V_{CC} - 0.11$	-	-	V
		$I_O = -1.1$ mA; $V_{CC} = 1.1$ V	$0.6 \times V_{CC}$	-	-	V
		$I_O = -1.7$ mA; $V_{CC} = 1.4$ V	0.93	-	-	V
		$I_O = -1.9$ mA; $V_{CC} = 1.65$ V	1.17	-	-	V
		$I_O = -2.3$ mA; $V_{CC} = 2.3$ V	1.77	-	-	V
		$I_O = -3.1$ mA; $V_{CC} = 2.3$ V	1.67	-	-	V
		$I_O = -2.7$ mA; $V_{CC} = 3.0$ V	2.40	-	-	V
$V_{OL}$	LOW-level output voltage	$V_I = V_{IH}$ or $V_{IL}$				
		$I_O = 20$ $\mu$ A; $V_{CC} = 0.8$ V to 3.6 V	-	-	0.11	V
		$I_O = 1.1$ mA; $V_{CC} = 1.1$ V	-	-	$0.33 \times V_{CC}$	V
		$I_O = 1.7$ mA; $V_{CC} = 1.4$ V	-	-	0.41	V
		$I_O = 1.9$ mA; $V_{CC} = 1.65$ V	-	-	0.39	V
		$I_O = 2.3$ mA; $V_{CC} = 2.3$ V	-	-	0.36	V
		$I_O = 3.1$ mA; $V_{CC} = 2.3$ V	-	-	0.50	V
		$I_O = 2.7$ mA; $V_{CC} = 3.0$ V	-	-	0.36	V
$I_I$	input leakage current	$V_I = \text{GND}$ to 3.6 V; $V_{CC} = 0$ V to 3.6 V	-	-	$\pm 0.75$	$\mu$ A
		$V_I = V_{IH}$ or $V_{IL}$ ; $V_O = 0$ V to 3.6 V; $V_{CC} = 0$ V to 3.6 V	-	-	$\pm 0.75$	$\mu$ A
$I_{OFF}$	power-off leakage current	$V_I$ or $V_O = 0$ V to 3.6 V; $V_{CC} = 0$ V	-	-	$\pm 0.75$	$\mu$ A

**Table 7. Static characteristics ...continued**

At recommended operating conditions; voltages are referenced to GND (ground = 0 V).

Symbol	Parameter	Conditions	Min	Typ	Max	Unit
$\Delta I_{OFF}$	additional power-off leakage current	$V_I$ or $V_O = 0$ V to 3.6 V; $V_{CC} = 0$ V to 0.2 V	-	-	$\pm 0.75$	$\mu$ A
$I_{CC}$	supply current	$V_I = GND$ or $V_{CC}$ ; $I_O = 0$ A; $V_{CC} = 0.8$ V to 3.6 V	-	-	1.4	$\mu$ A
$\Delta I_{CC}$	additional supply current	data input; $V_I = V_{CC} - 0.6$ V; $I_O = 0$ A; $V_{CC} = 3.3$ V	[1]	-	75	$\mu$ A
		$\overline{1OE}$ and $2OE$ input; $V_I = V_{CC} - 0.6$ V; $I_O = 0$ A; $V_{CC} = 3.3$ V	[1]	-	180	$\mu$ A
		all inputs; $V_I = GND$ to 3.6 V; $\overline{1OE} = V_{CC}$ ; $2OE = GND$ ; $V_{CC} = 0.8$ V to 3.6 V	[2]	-	1	$\mu$ A

[1] One input at  $V_{CC} - 0.6$  V, other input at  $V_{CC}$  or GND.[2] To show  $I_{CC}$  remains very low when the input-disable feature is enabled.

## 11. Dynamic characteristics

**Table 8. Dynamic characteristics**Voltages are referenced to GND (ground = 0 V); for test circuit see [Figure 10](#).

Symbol	Parameter	Conditions	25 °C			-40 °C to +125 °C			Unit
			Min	Typ [1]	Max	Min	Max (85 °C)	Max (125 °C)	

 $C_L = 5$  pF

$t_{pd}$	propagation delay	nA to nY; see <a href="#">Figure 7</a>	[2]						
		$V_{CC} = 0.8$ V	-	20.6	-	-	-	-	ns
		$V_{CC} = 1.1$ V to 1.3 V	2.8	5.5	10.5	2.5	11.7	12.9	ns
		$V_{CC} = 1.4$ V to 1.6 V	2.2	3.9	6.1	2.0	7.3	8.1	ns
		$V_{CC} = 1.65$ V to 1.95 V	1.9	3.2	4.8	1.7	6.1	6.7	ns
		$V_{CC} = 2.3$ V to 2.7 V	1.6	2.6	3.6	1.4	4.3	4.9	ns
		$V_{CC} = 3.0$ V to 3.6 V	1.4	2.4	3.1	1.2	3.9	4.4	ns



**Table 8. Dynamic characteristics ...continued**Voltages are referenced to GND (ground = 0 V); for test circuit see [Figure 10](#).

Symbol	Parameter	Conditions	25 °C			-40 °C to +125 °C			Unit
			Min	Typ <sup>[1]</sup>	Max	Min	Max (85 °C)	Max (125 °C)	
t <sub>en</sub>	enable time	1OE to 1Y; see <a href="#">Figure 8</a> <sup>[3]</sup>							
		V <sub>CC</sub> = 0.8 V	-	69.9	-	-	-	-	ns
		V <sub>CC</sub> = 1.1 V to 1.3 V	3.1	6.1	11.8	2.9	13.9	15.4	ns
		V <sub>CC</sub> = 1.4 V to 1.6 V	2.5	4.2	6.6	2.3	7.7	8.3	ns
		V <sub>CC</sub> = 1.65 V to 1.95 V	2.1	3.4	5.1	2.0	6.2	6.8	ns
		V <sub>CC</sub> = 2.3 V to 2.7 V	1.8	2.6	3.7	1.7	4.5	5.0	ns
		V <sub>CC</sub> = 3.0 V to 3.6 V	1.7	2.4	3.1	1.7	3.5	3.9	ns
		2OE to 2Y; see <a href="#">Figure 9</a> <sup>[3]</sup>							
		V <sub>CC</sub> = 0.8 V	-	71.6	-	-	-	-	ns
		V <sub>CC</sub> = 1.1 V to 1.3 V	2.8	6.2	12.4	2.6	13.6	13.6	ns
		V <sub>CC</sub> = 1.4 V to 1.6 V	2.3	4.2	6.9	2.2	7.4	7.7	ns
		V <sub>CC</sub> = 1.65 V to 1.95 V	1.9	3.3	5.3	1.7	5.9	6.2	ns
		V <sub>CC</sub> = 2.3 V to 2.7 V	1.5	2.4	3.6	1.4	3.8	4.1	ns
		V <sub>CC</sub> = 3.0 V to 3.6 V	1.3	2.0	2.9	1.2	3.2	3.4	ns
t <sub>dis</sub>	disable time	1OE to 1Y; see <a href="#">Figure 8</a> <sup>[4]</sup>							
		V <sub>CC</sub> = 0.8 V	-	14.3	-	-	-	-	ns
		V <sub>CC</sub> = 1.1 V to 1.3 V	2.7	4.3	6.5	2.7	7.3	8.2	ns
		V <sub>CC</sub> = 1.4 V to 1.6 V	2.1	3.2	4.4	2.1	5.1	5.7	ns
		V <sub>CC</sub> = 1.65 V to 1.95 V	2.0	3.0	4.3	2.0	5.0	5.7	ns
		V <sub>CC</sub> = 2.3 V to 2.7 V	1.4	2.2	2.9	1.4	3.3	4.1	ns
		V <sub>CC</sub> = 3.0 V to 3.6 V	1.7	2.5	3.2	1.7	3.4	3.9	ns
		2OE to 2Y; see <a href="#">Figure 9</a> <sup>[4]</sup>							
		V <sub>CC</sub> = 0.8 V	-	10.3	-	-	-	-	ns
		V <sub>CC</sub> = 1.1 V to 1.3 V	2.6	4.2	6.2	2.9	6.4	6.5	ns
		V <sub>CC</sub> = 1.4 V to 1.6 V	2.1	3.2	4.4	2.2	4.6	4.7	ns
		V <sub>CC</sub> = 1.65 V to 1.95 V	2.1	3.1	4.4	1.7	4.6	4.8	ns
		V <sub>CC</sub> = 2.3 V to 2.7 V	1.7	2.4	3.2	1.4	3.4	3.6	ns
		V <sub>CC</sub> = 3.0 V to 3.6 V	2.1	2.8	3.6	1.2	3.7	3.8	ns

**C<sub>L</sub> = 10 pF**

t <sub>pd</sub>	propagation delay	nA to nY; see <a href="#">Figure 7</a> <sup>[2]</sup>							
		V <sub>CC</sub> = 0.8 V	-	24.0	-	-	-	-	ns
		V <sub>CC</sub> = 1.1 V to 1.3 V	3.2	6.4	12.3	3.0	13.8	15.2	ns
		V <sub>CC</sub> = 1.4 V to 1.6 V	2.1	4.5	7.3	1.9	8.5	9.4	ns
		V <sub>CC</sub> = 1.65 V to 1.95 V	1.9	3.8	5.5	1.7	6.8	7.6	ns
		V <sub>CC</sub> = 2.3 V to 2.7 V	2.1	3.2	4.2	1.6	5.3	5.9	ns
		V <sub>CC</sub> = 3.0 V to 3.6 V	1.8	3.0	3.8	1.6	4.6	5.2	ns

**Table 8. Dynamic characteristics ...continued**Voltages are referenced to GND (ground = 0 V); for test circuit see [Figure 10](#).

Symbol	Parameter	Conditions	25 °C			–40 °C to +125 °C			Unit
			Min	Typ <sup>[1]</sup>	Max	Min	Max (85 °C)	Max (125 °C)	
t <sub>en</sub>	enable time	1 $\overline{\text{OE}}$ to 1Y; see <a href="#">Figure 8</a> <sup>[3]</sup>							
		V <sub>CC</sub> = 0.8 V	-	73.7	-	-	-	-	ns
		V <sub>CC</sub> = 1.1 V to 1.3 V	3.6	6.9	13.5	3.4	15.8	17.5	ns
		V <sub>CC</sub> = 1.4 V to 1.6 V	2.3	4.8	7.7	2.2	8.6	9.4	ns
		V <sub>CC</sub> = 1.65 V to 1.95 V	2.0	3.9	5.8	1.9	6.8	7.4	ns
		V <sub>CC</sub> = 2.3 V to 2.7 V	1.8	3.2	4.3	1.7	5.3	5.9	ns
		V <sub>CC</sub> = 3.0 V to 3.6 V	1.7	3.0	3.9	1.7	4.3	4.8	ns
		2OE to 2Y; see <a href="#">Figure 9</a> <sup>[3]</sup>							
		V <sub>CC</sub> = 0.8 V	-	75.3	-	-	-	-	ns
		V <sub>CC</sub> = 1.1 V to 1.3 V	3.2	7.1	14.1	3.0	15.4	15.4	ns
		V <sub>CC</sub> = 1.4 V to 1.6 V	2.2	4.8	8.0	2.1	8.3	8.6	ns
		V <sub>CC</sub> = 1.65 V to 1.95 V	1.8	3.9	5.9	1.7	6.5	6.8	ns
		V <sub>CC</sub> = 2.3 V to 2.7 V	1.5	2.9	4.2	1.4	4.5	4.8	ns
		V <sub>CC</sub> = 3.0 V to 3.6 V	1.4	2.6	3.6	1.3	3.8	4.0	ns
t <sub>dis</sub>	disable time	1 $\overline{\text{OE}}$ to 1Y; see <a href="#">Figure 8</a> <sup>[4]</sup>							
		V <sub>CC</sub> = 0.8 V	-	32.7	-	-	-	-	ns
		V <sub>CC</sub> = 1.1 V to 1.3 V	3.4	5.4	7.9	3.4	8.8	9.9	ns
		V <sub>CC</sub> = 1.4 V to 1.6 V	2.2	4.1	5.5	2.2	6.2	7.1	ns
		V <sub>CC</sub> = 1.65 V to 1.95 V	2.2	4.2	5.6	1.9	6.3	7.1	ns
		V <sub>CC</sub> = 2.3 V to 2.7 V	1.7	3.0	3.8	1.7	4.5	5.1	ns
		V <sub>CC</sub> = 3.0 V to 3.6 V	2.1	3.8	4.8	1.7	5.0	5.6	ns
		2OE to 2Y; see <a href="#">Figure 9</a> <sup>[4]</sup>							
		V <sub>CC</sub> = 0.8 V	-	12.2	-	-	-	-	ns
		V <sub>CC</sub> = 1.1 V to 1.3 V	3.5	5.3	7.6	3.3	7.9	7.9	ns
		V <sub>CC</sub> = 1.4 V to 1.6 V	2.2	4.1	5.6	2.1	5.7	5.9	ns
		V <sub>CC</sub> = 1.65 V to 1.95 V	2.4	4.2	5.7	1.7	5.8	6.0	ns
		V <sub>CC</sub> = 2.3 V to 2.7 V	1.9	3.2	4.1	1.4	4.3	4.5	ns
		V <sub>CC</sub> = 3.0 V to 3.6 V	2.4	4.1	5.0	1.3	5.2	5.3	ns

**Table 8. Dynamic characteristics ...continued**Voltages are referenced to GND (ground = 0 V); for test circuit see [Figure 10](#).

Symbol	Parameter	Conditions	25 °C			-40 °C to +125 °C			Unit
			Min	Typ <sup>[1]</sup>	Max	Min	Max (85 °C)	Max (125 °C)	
<b>C<sub>L</sub> = 15 pF</b>									
t <sub>pd</sub>	propagation delay	nA to nY; see <a href="#">Figure 7</a>	<a href="#">[2]</a>						
		V <sub>CC</sub> = 0.8 V	-	27.4	-	-	-	-	ns
		V <sub>CC</sub> = 1.1 V to 1.3 V	3.6	7.2	14.1	3.3	15.8	17.5	ns
		V <sub>CC</sub> = 1.4 V to 1.6 V	3.0	5.1	8.1	2.5	9.8	10.9	ns
		V <sub>CC</sub> = 1.65 V to 1.95 V	2.2	4.3	6.3	2.0	7.9	8.8	ns
		V <sub>CC</sub> = 2.3 V to 2.7 V	2.0	3.7	4.9	1.8	6.0	6.7	ns
		V <sub>CC</sub> = 3.0 V to 3.6 V	2.0	3.5	4.4	1.8	5.4	6.1	ns
t <sub>en</sub>	enable time	1OE to 1Y; see <a href="#">Figure 8</a>	<a href="#">[3]</a>						
		V <sub>CC</sub> = 0.8 V	-	77.5	-	-	-	-	ns
		V <sub>CC</sub> = 1.1 V to 1.3 V	4.0	7.7	15.2	3.7	17.6	19.6	ns
		V <sub>CC</sub> = 1.4 V to 1.6 V	3.0	5.3	8.4	2.5	9.8	10.7	ns
		V <sub>CC</sub> = 1.65 V to 1.95 V	2.3	4.4	6.5	2.1	7.7	8.5	ns
		V <sub>CC</sub> = 2.3 V to 2.7 V	2.1	3.6	5.0	2.0	6.1	6.8	ns
		V <sub>CC</sub> = 3.0 V to 3.6 V	2.0	3.5	4.5	1.9	4.9	5.5	ns
		2OE to 2Y; see <a href="#">Figure 9</a>	<a href="#">[3]</a>						
		V <sub>CC</sub> = 0.8 V	-	79.2	-	-	-	-	ns
		V <sub>CC</sub> = 1.1 V to 1.3 V	3.6	7.8	15.8	3.3	17.1	17.1	ns
		V <sub>CC</sub> = 1.4 V to 1.6 V	3.0	5.4	8.8	2.9	9.4	9.7	ns
		V <sub>CC</sub> = 1.65 V to 1.95 V	2.1	4.3	6.7	2.0	7.3	7.7	ns
		V <sub>CC</sub> = 2.3 V to 2.7 V	1.8	3.4	4.8	1.7	5.2	5.6	ns
		V <sub>CC</sub> = 3.0 V to 3.6 V	1.6	3.1	4.3	1.5	4.5	4.7	ns
t <sub>dis</sub>	disable time	1OE to 1Y; see <a href="#">Figure 8</a>	<a href="#">[4]</a>						
		V <sub>CC</sub> = 0.8 V	-	60.8	-	-	-	-	ns
		V <sub>CC</sub> = 1.1 V to 1.3 V	4.3	6.5	9.2	3.7	10.3	11.6	ns
		V <sub>CC</sub> = 1.4 V to 1.6 V	3.0	5.0	6.5	2.5	7.4	8.4	ns
		V <sub>CC</sub> = 1.65 V to 1.95 V	3.0	5.3	6.6	2.1	7.4	8.9	ns
		V <sub>CC</sub> = 2.3 V to 2.7 V	2.1	3.8	4.9	2.0	5.1	6.4	ns
		V <sub>CC</sub> = 3.0 V to 3.6 V	2.9	5.0	6.2	1.9	6.6	7.4	ns
		2OE to 2Y; see <a href="#">Figure 9</a>	<a href="#">[4]</a>						
		V <sub>CC</sub> = 0.8 V	-	14.9	-	-	-	-	ns
		V <sub>CC</sub> = 1.1 V to 1.3 V	4.3	6.4	8.5	3.7	9.3	9.4	ns
		V <sub>CC</sub> = 1.4 V to 1.6 V	3.0	5.0	6.6	2.5	6.9	7.0	ns
		V <sub>CC</sub> = 1.65 V to 1.95 V	3.1	5.4	6.6	2.0	7.4	7.5	ns
		V <sub>CC</sub> = 2.3 V to 2.7 V	2.4	4.0	5.0	1.7	5.1	5.5	ns
		V <sub>CC</sub> = 3.0 V to 3.6 V	3.2	5.3	6.2	1.5	6.7	6.9	ns

**Table 8. Dynamic characteristics ...continued**Voltages are referenced to GND (ground = 0 V); for test circuit see [Figure 10](#).

Symbol	Parameter	Conditions	25 °C			-40 °C to +125 °C			Unit
			Min	Typ <sup>[1]</sup>	Max	Min	Max (85 °C)	Max (125 °C)	
<b>C<sub>L</sub> = 30 pF</b>									
t <sub>pd</sub>	propagation delay	nA to nY; see <a href="#">Figure 7</a>		[2]					
		V <sub>CC</sub> = 0.8 V	-	37.4	-	-	-	-	ns
		V <sub>CC</sub> = 1.1 V to 1.3 V	4.8	9.5	19.0	4.4	21.6	24.0	ns
		V <sub>CC</sub> = 1.4 V to 1.6 V	4.0	6.7	10.8	3.0	13.0	14.5	ns
		V <sub>CC</sub> = 1.65 V to 1.95 V	2.9	5.6	8.4	2.6	10.3	11.5	ns
		V <sub>CC</sub> = 2.3 V to 2.7 V	2.7	4.8	6.3	2.5	7.8	8.7	ns
		V <sub>CC</sub> = 3.0 V to 3.6 V	2.7	4.6	5.8	2.5	7.0	8.3	ns
t <sub>en</sub>	enable time	1OE to 1Y; see <a href="#">Figure 8</a>		[3]					
		V <sub>CC</sub> = 0.8 V	-	88.9	-	-	-	-	ns
		V <sub>CC</sub> = 1.1 V to 1.3 V	5.2	9.9	19.8	4.8	22.8	25.3	ns
		V <sub>CC</sub> = 1.4 V to 1.6 V	4.0	6.8	10.8	3.1	12.6	14.1	ns
		V <sub>CC</sub> = 1.65 V to 1.95 V	3.0	5.6	8.5	2.8	10.2	11.3	ns
		V <sub>CC</sub> = 2.3 V to 2.7 V	2.7	4.8	6.5	2.6	7.8	8.8	ns
		V <sub>CC</sub> = 3.0 V to 3.6 V	2.7	4.6	6.0	2.6	6.9	7.7	ns
		2OE to 2Y; see <a href="#">Figure 9</a>		[3]					
		V <sub>CC</sub> = 0.8 V	-	90.6	-	-	-	-	ns
		V <sub>CC</sub> = 1.1 V to 1.3 V	4.7	10.0	20.4	4.3	22.0	22.0	ns
		V <sub>CC</sub> = 1.4 V to 1.6 V	3.0	6.9	11.3	3.7	12.0	12.5	ns
		V <sub>CC</sub> = 1.65 V to 1.95 V	2.6	5.6	8.6	3.2	9.5	10.1	ns
		V <sub>CC</sub> = 2.3 V to 2.7 V	2.3	4.5	6.3	2.9	6.8	7.3	ns
		V <sub>CC</sub> = 3.0 V to 3.6 V	2.2	4.2	5.8	2.7	6.4	6.7	ns
t <sub>dis</sub>	disable time	1OE to 1Y; see <a href="#">Figure 8</a>		[4]					
		V <sub>CC</sub> = 0.8 V	-	49.9	-	-	-	-	ns
		V <sub>CC</sub> = 1.1 V to 1.3 V	6.0	9.9	13.3	4.8	14.8	16.5	ns
		V <sub>CC</sub> = 1.4 V to 1.6 V	4.4	7.7	9.6	3.1	10.7	12.1	ns
		V <sub>CC</sub> = 1.65 V to 1.95 V	5.1	8.7	11.1	2.8	12.4	13.8	ns
		V <sub>CC</sub> = 2.3 V to 2.7 V	3.6	6.2	7.4	2.6	8.6	9.6	ns
		V <sub>CC</sub> = 3.0 V to 3.6 V	5.2	8.7	10.5	2.6	10.8	13.1	ns
		2OE to 2Y; see <a href="#">Figure 9</a>		[4]					
		V <sub>CC</sub> = 0.8 V	-	51.6	-	-	-	-	ns
		V <sub>CC</sub> = 1.1 V to 1.3 V	6.0	9.8	13.6	4.7	14.3	14.4	ns
		V <sub>CC</sub> = 1.4 V to 1.6 V	4.5	7.7	10.5	3.0	10.7	11.0	ns
		V <sub>CC</sub> = 1.65 V to 1.95 V	5.2	8.8	11.4	2.6	11.5	11.6	ns
		V <sub>CC</sub> = 2.3 V to 2.7 V	3.9	6.4	7.4	2.3	9.0	10.2	ns
		V <sub>CC</sub> = 3.0 V to 3.6 V	5.5	9.0	10.7	2.2	10.8	12.0	ns

**Table 8. Dynamic characteristics ...continued**

Voltages are referenced to GND (ground = 0 V); for test circuit see [Figure 10](#).

Symbol	Parameter	Conditions	25 °C			-40 °C to +125 °C			Unit
			Min	Typ <sup>[1]</sup>	Max	Min	Max (85 °C)	Max (125 °C)	
<b><math>C_L = 5 \text{ pF}, 10 \text{ pF}, 15 \text{ pF}</math> and <math>30 \text{ pF}</math></b>									
$C_{PD}$	power dissipation capacitance	$f = 1 \text{ MHz}; V_I = \text{GND to } V_{CC}$ <sup>[5]</sup>							
		$V_{CC} = 0.8 \text{ V}$	-	2.8	-	-	-	-	pF
		$V_{CC} = 1.1 \text{ V to } 1.3 \text{ V}$	-	2.8	-	-	-	-	pF
		$V_{CC} = 1.4 \text{ V to } 1.6 \text{ V}$	-	3.0	-	-	-	-	pF
		$V_{CC} = 1.65 \text{ V to } 1.95 \text{ V}$	-	3.0	-	-	-	-	pF
		$V_{CC} = 2.3 \text{ V to } 2.7 \text{ V}$	-	3.7	-	-	-	-	pF
		$V_{CC} = 3.0 \text{ V to } 3.6 \text{ V}$	-	4.2	-	-	-	-	pF

[1] All typical values are measured at nominal  $V_{CC}$ .

[2]  $t_{pd}$  is the same as  $t_{PLH}$  and  $t_{PHL}$ .

[3]  $t_{en}$  is the same as  $t_{PZH}$  and  $t_{PZL}$ .

[4]  $t_{dis}$  is the same as  $t_{PHZ}$  and  $t_{PLZ}$ .

[5]  $C_{PD}$  is used to determine the dynamic power dissipation ( $P_D$  in  $\mu\text{W}$ ).

$$P_D = C_{PD} \times V_{CC}^2 \times f_i \times N + \Sigma(C_L \times V_{CC}^2 \times f_o) \text{ where:}$$

$f_i$  = input frequency in MHz;

$f_o$  = output frequency in MHz;

$C_L$  = output load capacitance in pF;

$V_{CC}$  = supply voltage in V;

$N$  = number of inputs switching;

$\Sigma(C_L \times V_{CC}^2 \times f_o)$  = sum of the outputs.

## 12. Waveforms

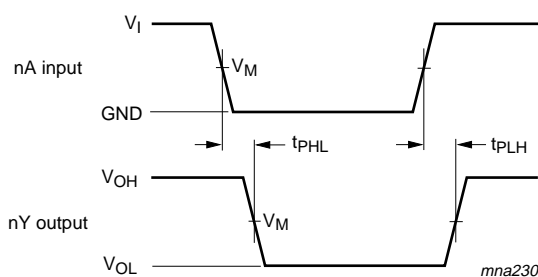

Measurement points are given in [Table 9](#).

Logic levels:  $V_{OL}$  and  $V_{OH}$  are typical output voltage drop that occur with the output load.

**Fig 7. The data input (nA) to output (nY) propagation delays**

**Table 9. Measurement points**

Supply voltage	Output	Input		
$V_{CC}$	$V_M$	$V_M$	$V_I$	$t_r = t_f$
0.8 V to 3.6 V	$0.5 \times V_{CC}$	$0.5 \times V_{CC}$	$V_{CC}$	$\leq 3.0 \text{ ns}$

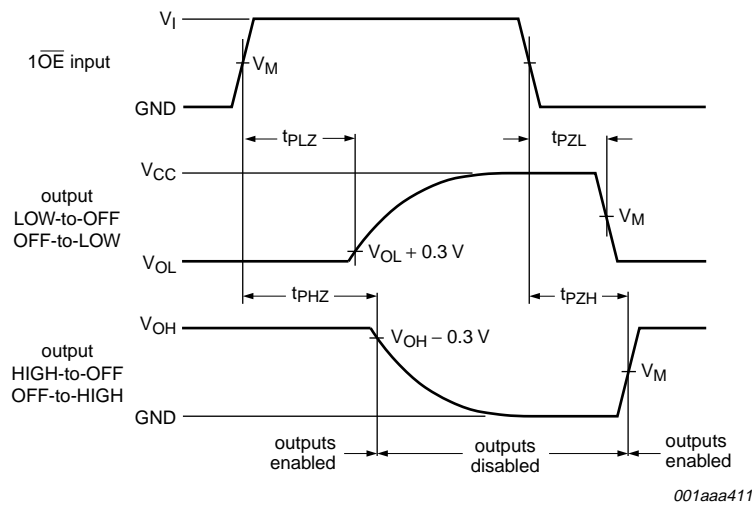

Measurement points are given in [Table 10](#).

Logic levels:  $V_{OL}$  and  $V_{OH}$  are typical output voltage drop that occur with the output load.

**Fig 8. 3-state enable and disable times**

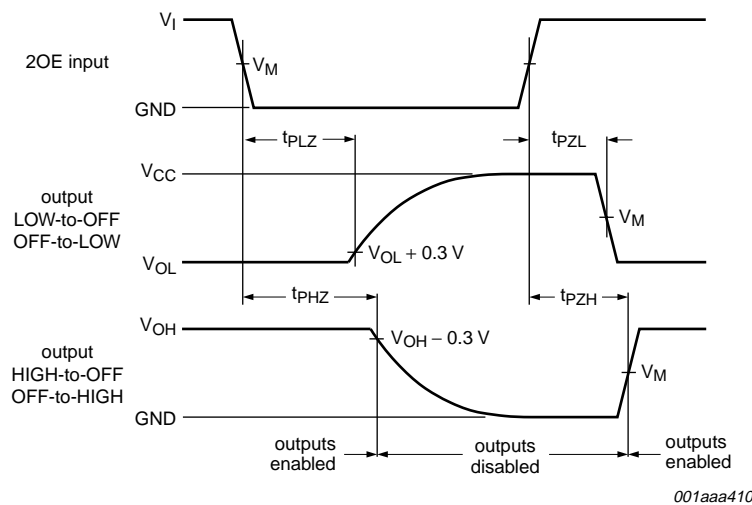

Measurement points are given in [Table 10](#).

Logic levels:  $V_{OL}$  and  $V_{OH}$  are typical output voltage drop that occur with the output load.

**Fig 9. 3-state enable and disable times**

**Table 10. Measurement points**

Supply voltage	Input	Output		
$V_{CC}$	$V_M$	$V_M$	$V_X$	$V_Y$
0.8 V to 1.6 V	$0.5 \times V_{CC}$	$0.5 \times V_{CC}$	$V_{OL} + 0.1 \text{ V}$	$V_{OH} - 0.1 \text{ V}$
1.65 V to 2.7 V	$0.5 \times V_{CC}$	$0.5 \times V_{CC}$	$V_{OL} + 0.15 \text{ V}$	$V_{OH} - 0.15 \text{ V}$
3.0 V to 3.6 V	$0.5 \times V_{CC}$	$0.5 \times V_{CC}$	$V_{OL} + 0.3 \text{ V}$	$V_{OH} - 0.3 \text{ V}$

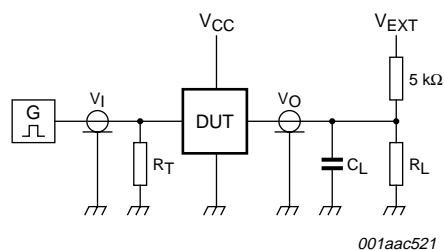

Test data is given in [Table 11](#).

Definitions for test circuit:

$R_L$  = Load resistance.

$C_L$  = Load capacitance including jig and probe capacitance.

$R_T$  = Termination resistance should be equal to the output impedance  $Z_o$  of the pulse generator.

$V_{EXT}$  = External voltage for measuring switching times.

**Fig 10. Load circuitry for switching times**

**Table 11. Test data**

Supply voltage	Load		$V_{EXT}$		
$V_{CC}$	$C_L$	$R_L$ [1]	$t_{PLH}$ , $t_{PHL}$	$t_{PZH}$ , $t_{PHZ}$	$t_{PZL}$ , $t_{PLZ}$
0.8 V to 3.6 V	5 pF, 10 pF, 15 pF and 30 pF	5 kΩ or 1 MΩ	open	GND	$2 \times V_{CC}$

[1] For measuring enable and disable times  $R_L = 5 \text{ k}\Omega$ , for measuring propagation delays, setup and hold times and pulse width  $R_L = 1 \text{ M}\Omega$ .

13. Package outline

VSSOP8: plastic very thin shrink small outline package; 8 leads; body width 2.3 mm

SOT765-1

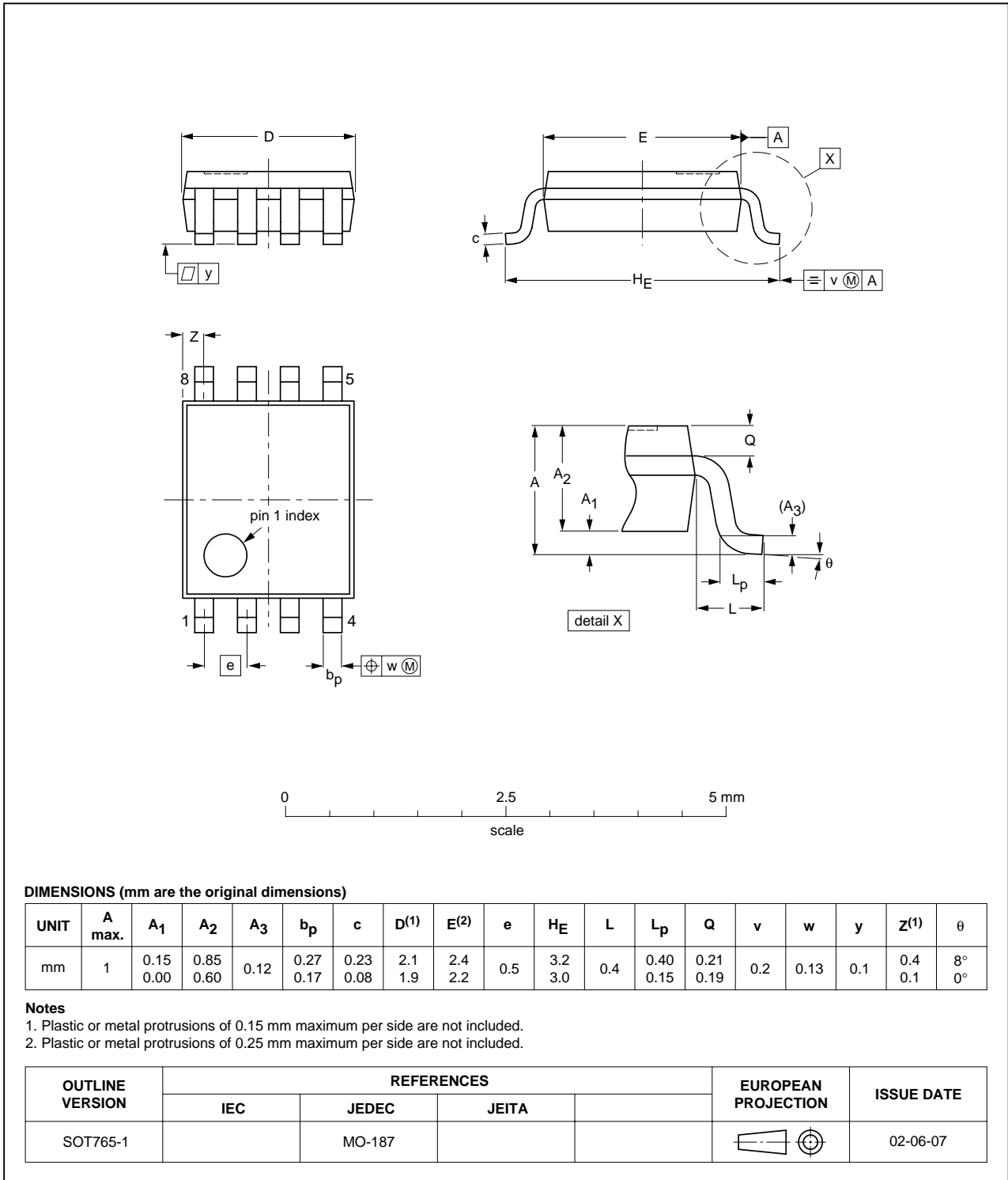

Fig 11. Package outline SOT765-1 (VSSOP8)



XSON8: plastic extremely thin small outline package; no leads; 8 terminals; body 1 x 1.95 x 0.5 mm

SOT833-1

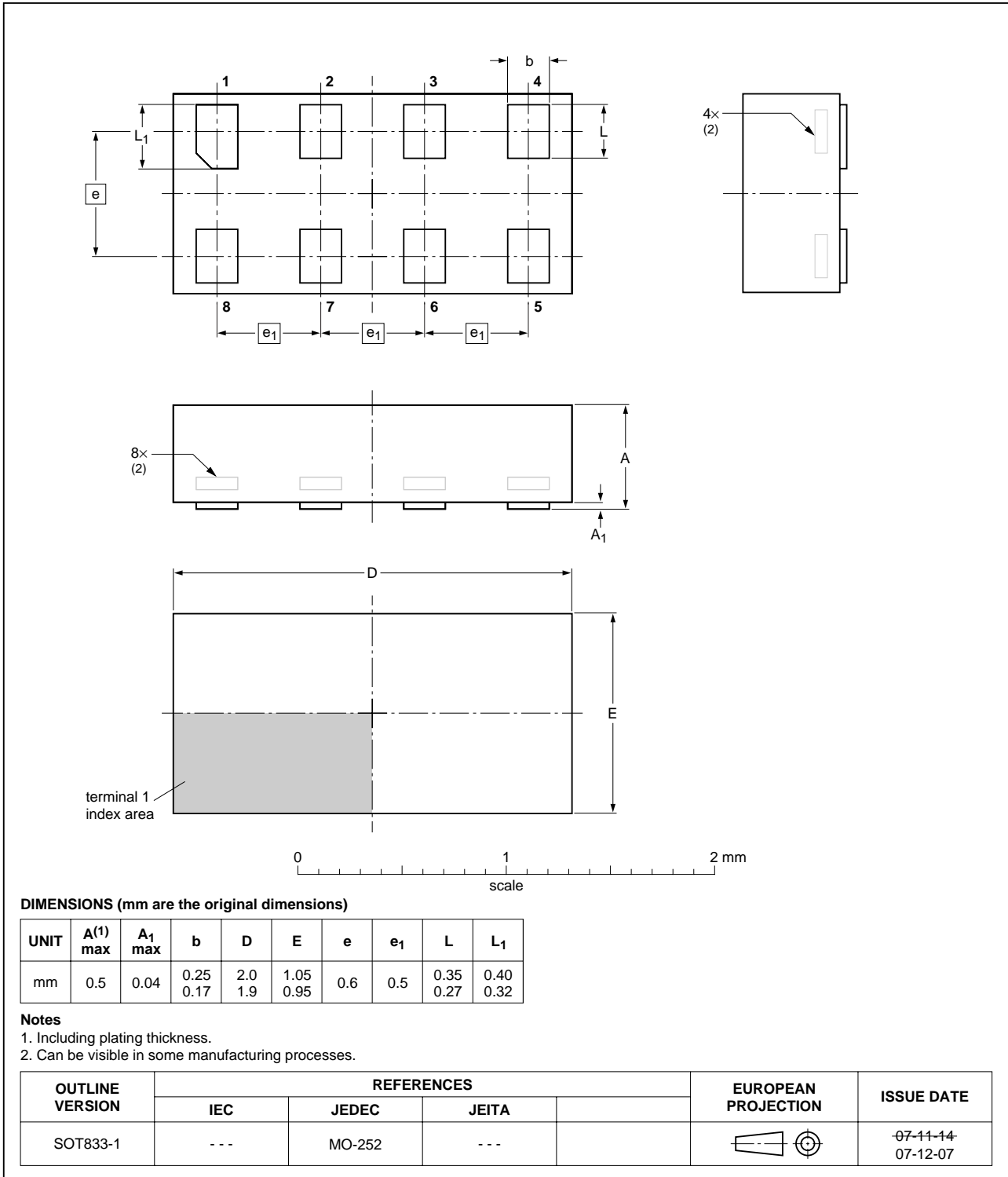

Fig 12. Package outline SOT833-1 (XSON8)

XSON8U: plastic extremely thin small outline package; no leads;  
8 terminals; UTLP based; body 3 x 2 x 0.5 mm

SOT996-2

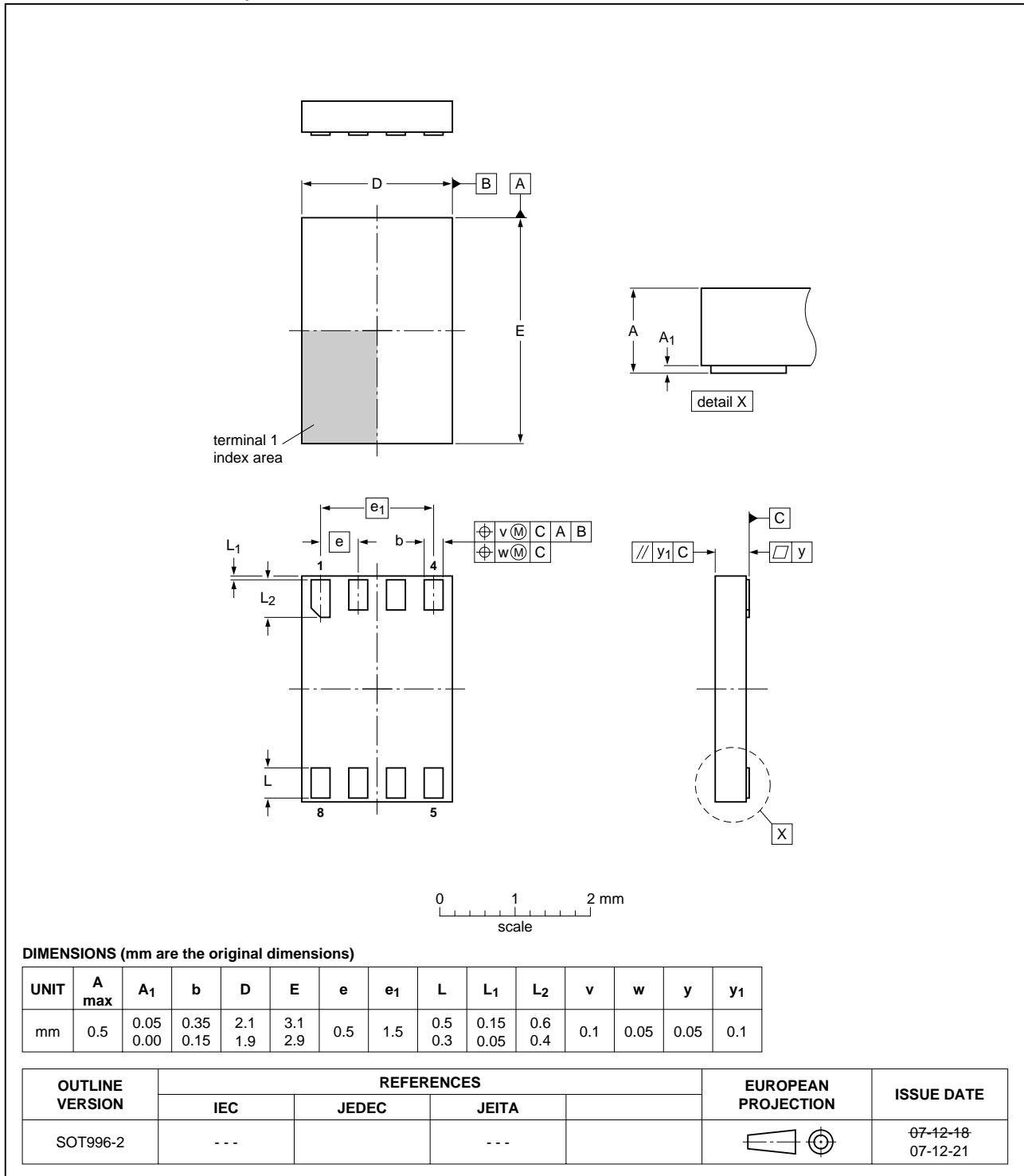
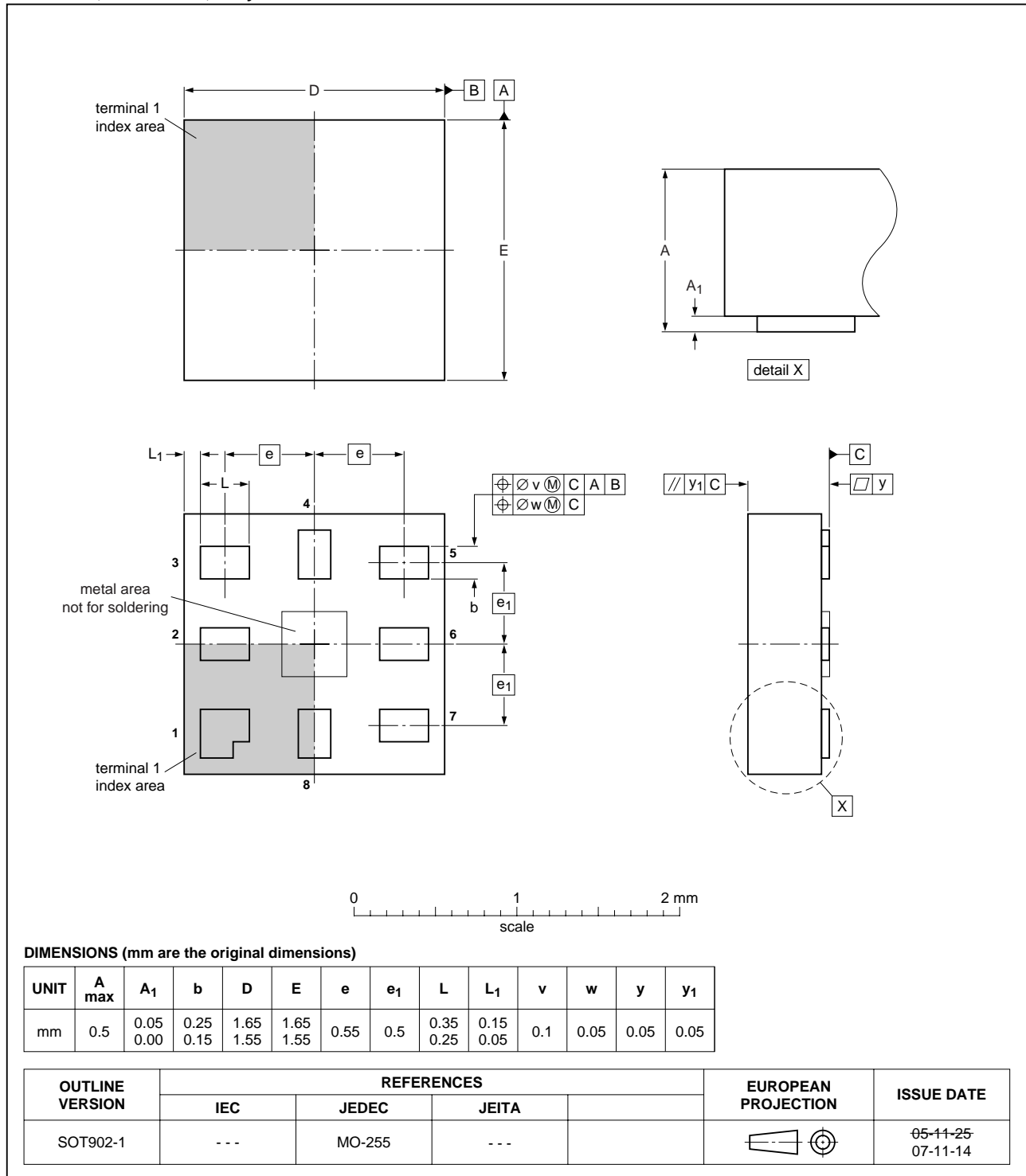

Fig 13. Package outline SOT996-2 (XSON8U)

**XQFN8U: plastic extremely thin quad flat package; no leads; 8 terminals; UTLP based; body 1.6 x 1.6 x 0.5 mm**

**SOT902-1**



**Fig 14. Package outline SOT902-1 (XQFN8U)**

## 14. Abbreviations

**Table 12. Abbreviations**

Acronym	Description
CDM	Charged Device Model
CMOS	Complementary Metal-Oxide Semiconductor
DUT	Device Under Test
ESD	ElectroStatic Discharge
HBM	Human Body Model
MM	Machine Model
TTL	Transistor-Transistor Logic

## 15. Revision history

**Table 13. Revision history**

Document ID	Release date	Data sheet status	Change notice	Supersedes
74AUP2G241_3	20090112	Product data sheet	-	74AUP2G241_2
Modifications:	<ul style="list-style-type: none"> <li>Added type number 74AUP2G241GD (XSON8U package).</li> </ul>			
74AUP2G241_2	20080219	Product data sheet	-	74AUP2G241_1
74AUP2G241_1	20061012	Product data sheet	-	-

## 16. Legal information

### 16.1 Data sheet status

Document status <sup>[1][2]</sup>	Product status <sup>[3]</sup>	Definition
Objective [short] data sheet	Development	This document contains data from the objective specification for product development.
Preliminary [short] data sheet	Qualification	This document contains data from the preliminary specification.
Product [short] data sheet	Production	This document contains the product specification.

[1] Please consult the most recently issued document before initiating or completing a design.

[2] The term 'short data sheet' is explained in section "Definitions".

[3] The product status of device(s) described in this document may have changed since this document was published and may differ in case of multiple devices. The latest product status information is available on the Internet at URL <http://www.nxp.com>.

### 16.2 Definitions

**Draft** — The document is a draft version only. The content is still under internal review and subject to formal approval, which may result in modifications or additions. NXP Semiconductors does not give any representations or warranties as to the accuracy or completeness of information included herein and shall have no liability for the consequences of use of such information.

**Short data sheet** — A short data sheet is an extract from a full data sheet with the same product type number(s) and title. A short data sheet is intended for quick reference only and should not be relied upon to contain detailed and full information. For detailed and full information see the relevant full data sheet, which is available on request via the local NXP Semiconductors sales office. In case of any inconsistency or conflict with the short data sheet, the full data sheet shall prevail.

### 16.3 Disclaimers

**General** — Information in this document is believed to be accurate and reliable. However, NXP Semiconductors does not give any representations or warranties, expressed or implied, as to the accuracy or completeness of such information and shall have no liability for the consequences of use of such information.

**Right to make changes** — NXP Semiconductors reserves the right to make changes to information published in this document, including without limitation specifications and product descriptions, at any time and without notice. This document supersedes and replaces all information supplied prior to the publication hereof.

**Suitability for use** — NXP Semiconductors products are not designed, authorized or warranted to be suitable for use in medical, military, aircraft, space or life support equipment, nor in applications where failure or

malfunction of an NXP Semiconductors product can reasonably be expected to result in personal injury, death or severe property or environmental damage. NXP Semiconductors accepts no liability for inclusion and/or use of NXP Semiconductors products in such equipment or applications and therefore such inclusion and/or use is at the customer's own risk.

**Applications** — Applications that are described herein for any of these products are for illustrative purposes only. NXP Semiconductors makes no representation or warranty that such applications will be suitable for the specified use without further testing or modification.

**Limiting values** — Stress above one or more limiting values (as defined in the Absolute Maximum Ratings System of IEC 60134) may cause permanent damage to the device. Limiting values are stress ratings only and operation of the device at these or any other conditions above those given in the Characteristics sections of this document is not implied. Exposure to limiting values for extended periods may affect device reliability.

**Terms and conditions of sale** — NXP Semiconductors products are sold subject to the general terms and conditions of commercial sale, as published at <http://www.nxp.com/profile/terms>, including those pertaining to warranty, intellectual property rights infringement and limitation of liability, unless explicitly otherwise agreed to in writing by NXP Semiconductors. In case of any inconsistency or conflict between information in this document and such terms and conditions, the latter will prevail.

**No offer to sell or license** — Nothing in this document may be interpreted or construed as an offer to sell products that is open for acceptance or the grant, conveyance or implication of any license under any copyrights, patents or other industrial or intellectual property rights.

### 16.4 Trademarks

Notice: All referenced brands, product names, service names and trademarks are the property of their respective owners.

## 17. Contact information

For more information, please visit: <http://www.nxp.com>

For sales office addresses, please send an email to: [salesaddresses@nxp.com](mailto:salesaddresses@nxp.com)

## 18. Contents

<b>1</b>	<b>General description</b> .....	<b>1</b>
<b>2</b>	<b>Features</b> .....	<b>1</b>
<b>3</b>	<b>Ordering information</b> .....	<b>2</b>
<b>4</b>	<b>Marking</b> .....	<b>2</b>
<b>5</b>	<b>Functional diagram</b> .....	<b>2</b>
<b>6</b>	<b>Pinning information</b> .....	<b>3</b>
6.1	Pinning .....	3
6.2	Pin description .....	3
<b>7</b>	<b>Functional description</b> .....	<b>4</b>
<b>8</b>	<b>Limiting values</b> .....	<b>4</b>
<b>9</b>	<b>Recommended operating conditions</b> .....	<b>4</b>
<b>10</b>	<b>Static characteristics</b> .....	<b>5</b>
<b>11</b>	<b>Dynamic characteristics</b> .....	<b>8</b>
<b>12</b>	<b>Waveforms</b> .....	<b>13</b>
<b>13</b>	<b>Package outline</b> .....	<b>16</b>
<b>14</b>	<b>Abbreviations</b> .....	<b>20</b>
<b>15</b>	<b>Revision history</b> .....	<b>20</b>
<b>16</b>	<b>Legal information</b> .....	<b>21</b>
16.1	Data sheet status .....	21
16.2	Definitions .....	21
16.3	Disclaimers .....	21
16.4	Trademarks .....	21
<b>17</b>	<b>Contact information</b> .....	<b>21</b>
<b>18</b>	<b>Contents</b> .....	<b>22</b>

Please be aware that important notices concerning this document and the product(s) described herein, have been included in section 'Legal information'.

founded by

**PHILIPS**

© NXP B.V. 2009.

All rights reserved.

For more information, please visit: <http://www.nxp.com>

For sales office addresses, please send an email to: [salesaddresses@nxp.com](mailto:salesaddresses@nxp.com)

Date of release: 12 January 2009

Document identifier: 74AUP2G241\_3