

74F164A Serial-In, Parallel-Out Shift Register

General Description

The 74F164A is a high-speed 8-bit serial-in/parallel-out shift register. Serial data is entered through a 2-input AND gate synchronous with the LOW-to-HIGH transition of the clock. The device features an asynchronous Master Reset which clears the register, setting all outputs LOW independent of the clock. The 74F164A is a faster version of the 74F164.

Features

- Typical shift frequency of 90 MHz
- Asynchronous Master Reset
- Gated serial data input
- Fully synchronous data transfers
- 74F164A is a faster version of the 74F164

Ordering Code:

Order Number	Package Number	Package Description
74F164ASC	M14A	14-Lead Small Outline Integrated Circuit (SOIC), JEDEC MS-120, 0.150 Narrow
74F164ASJ	M14D	14-Lead Small Outline Package (SOP), EIAJ TYPE II, 5.3mm Wide
74F164APC	N14A	14-Lead Plastic Dual-In-Line Package (PDIP), JEDEC MS-001, 0.300 Wide

Devices also available in Tape and Reel. Specify by appending the suffix letter "X" to the ordering code.

Logic Symbols

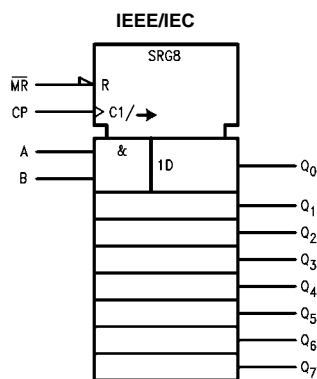
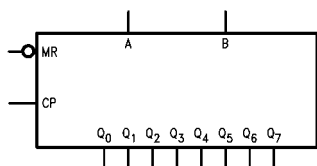

Connection Diagram

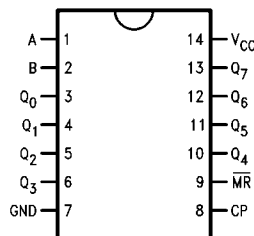

Unit Loading/Fan Out

Pin Names	Description	U.L. HIGH/LOW	Input I_{IH}/I_{IL} Output I_{OH}/I_{OL}
A, B	Data Inputs	1.0/1.0	20 μ A/-0.6 mA
CP	Clock Pulse Input (Active Rising Edge)	1.0/1.0	20 μ A/-0.6 mA
\overline{MR}	Master Reset Input (Active LOW)	1.0/1.0	20 μ A/-0.6 mA
Q_0 - Q_7	Outputs	50/33.3	-1 mA/20 mA

Functional Description

The 74F164A is an edge-triggered 8-bit shift register with serial data entry and an output from each of the eight stages. Data is entered serially through one of two inputs (A or B); either of these inputs can be used as an active HIGH Enable for data entry through the other input. An unused input must be tied HIGH.

Each LOW-to-HIGH transition on the Clock (CP) input shifts data one place to the right and enters into Q_0 the logical AND of the two data inputs ($A \cdot B$) that existed before the rising clock edge. A LOW level on the Master Reset (\overline{MR}) input overrides all other inputs and clears the register asynchronously, forcing all Q outputs LOW.

Mode Select Table

Operating Mode	Inputs			Outputs	
	\overline{MR}	A	B	Q_0	Q_1 - Q_7
Reset (Clear)	L	X	X	L	L-L
Shift	H	l	l	L	q_0 - q_6
	H	l	h	L	q_0 - q_6
	H	h	l	L	q_0 - q_6
	H	h	h	H	q_0 - q_6

H(h) = HIGH Voltage Levels
 L(l) = LOW Voltage Levels
 X = Immaterial
 q_n = Lower case letters indicate the state of the referenced input or output one setup time prior to the LOW-to-HIGH clock transition.

Logic Diagram

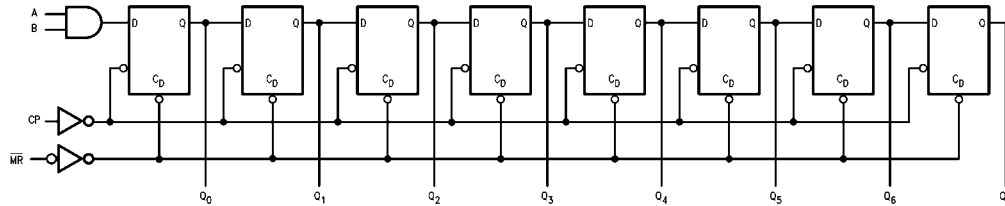

Please note that this diagram is provided only for the understanding of logic operations and should not be used to estimate propagation delays.

Absolute Maximum Ratings(Note 1)

Storage Temperature	-65°C to +150°C
Ambient Temperature under Bias	-55°C to +125°C
Junction Temperature under Bias	-55°C to +150°C
V _{CC} Pin Potential to Ground Pin	-0.5V to +7.0V
Input Voltage (Note 1)	-0.5V to +7.0V
Input Current (Note 1)	-30 mA to +5.0 mA
Voltage Applied to Output in HIGH State (with V _{CC} = 0V)	
Standard Output	-0.5V to V _{CC}
3-STATE Output	-0.5V to +5.5V
Current Applied to Output in LOW State (Max)	twice the rated I _{OL} (mA)
ESD Last Passing Voltage (Min)	4000V

Recommended Operating Conditions

Free Air Ambient Temperature	0°C to +70°C
Supply Voltage	+4.5V to +5.5V

Note 1: Absolute maximum ratings are values beyond which the device may be damaged or have its useful life impaired. Functional operation under these conditions is not implied.

Note 2: Either voltage limit or current limit is sufficient to protect inputs.

DC Electrical Characteristics

Symbol	Parameter	Min	Typ	Max	Units	V _{CC}	Conditions
V _{IH}	Input HIGH Voltage	2.0			V		Recognized as a HIGH Signal
V _{IL}	Input LOW Voltage			0.8	V		Recognized as a LOW Signal
V _{CD}	Input Clamp Diode Voltage			-1.2	V	Min	I _{IN} = -18 mA
V _{OH}	Output HIGH Voltage	10% V _{CC} 5% V _{CC}			V	Min	I _{OH} = -1 mA I _{OH} = -1 mA
V _{OL}	Output LOW Voltage	10% V _{CC}		0.5	V	Min	I _{OL} = 20 mA
I _{IH}	Input HIGH Current			5.0	μA	Max	V _{IN} = 2.7V
I _{BVI}	Input HIGH Current Breakdown Test			7.0	μA	Max	V _{IN} = 7.0V
I _{CEx}	Output HIGH Leakage Current			50	μA	Max	V _{OUT} = V _{CC}
V _{ID}	Input Leakage Test	4.75			V	0.0	I _{ID} = 1.9 μA All other pins grounded
I _{OD}	Output Leakage Circuit Current			3.75	μA	0.0	V _{IOD} = 150 mV All other pins grounded
I _{IL}	Input LOW Current			-0.6	mA	Max	V _{IN} = 0.5V
I _{OS}	Output Short-Circuit Current	-60		-150	mA	Max	V _{OUT} = 0V
I _{CC}	Power Supply Current		35	55	mA	Max	CP = HIGH MR = GND, A, B = GND

AC Electrical Characteristics

Symbol	Parameter	$T_A = +25^\circ\text{C}$ $V_{CC} = +5.0\text{V}$ $C_L = 50\text{ pF}$			$T_A = -55^\circ\text{C to } +125^\circ\text{C}$ $V_{CC} = 5.0\text{V}$ $C_L = 50\text{ pF}$		$T_A = 0^\circ\text{C to } +70^\circ\text{C}$ $V_{CC} = 5.0\text{V}$ $C_L = 50\text{ pF}$		Units
		Min	Typ	Max	Min	Max	Min	Max	
f_{MAX}	Maximum Clock Frequency	80	120		60		80		MHz
t_{PLH}	Propagation Delay CP to Q_n	3.0	4.8	7.5	2.5	9.0	3.0	7.5	ns
t_{PHL}	Propagation Delay \overline{MR} to Q_n	3.5	5.0	8.0	3.0	8.5	3.5	8.0	
t_{PHL}	Propagation Delay \overline{MR} to Q_n	5.0	7.0	10.0	4.0	12.5	5.0	10.5	ns

AC Operating Requirements

Symbol	Parameter	$T_A = +25^\circ\text{C}$ $V_{CC} = +5.0\text{V}$		$T_A = -55^\circ\text{C to } +125^\circ\text{C}$ $V_{CC} = 5.0\text{V}$		$T_A = 0^\circ\text{C to } +70^\circ\text{C}$ $V_{CC} = 5.0\text{V}$		Units
		Min	Max	Min	Max	Min	Max	
$t_{S(H)}$	Setup Time, HIGH or LOW	4.5		5.5		4.5		ns
$t_{S(L)}$	A or B to CP	4.0		4.0		4.0		
$t_{H(H)}$	Hold Time, HIGH or LOW	1.0		1.0		1.0		
$t_{H(L)}$	A or B to CP	1.0		1.0		1.0		ns
$t_{W(H)}$	CP Pulse Width HIGH or LOW	4.0		4.0		4.0		
$t_{W(L)}$	\overline{MR} Pulse Width, LOW	4.0		5.0		4.0		ns
t_{REC}	Recovery Time \overline{MR} to CP	5.0		6.5		5.0		ns

Physical Dimensions inches (millimeters) unless otherwise noted

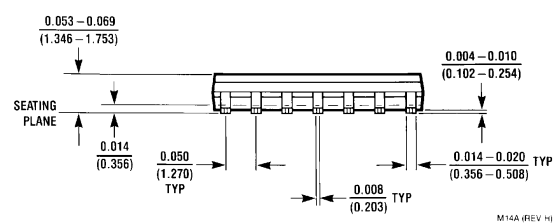
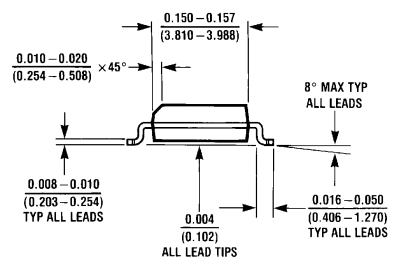
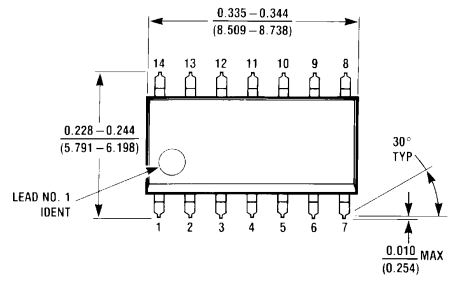

M14A (REV H)

14-Lead Small Outline Integrated Circuit (SOIC), JEDEC MS-120, 0.150 Narrow Package Number M14A

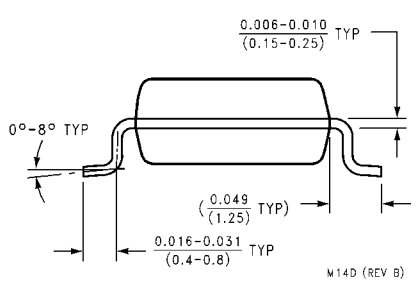
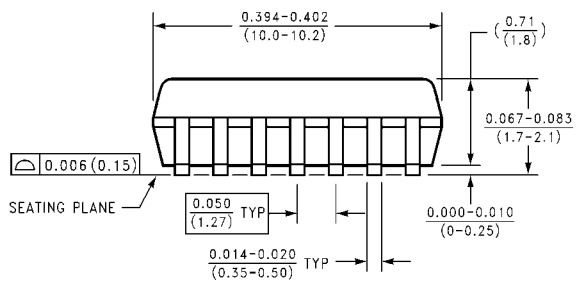
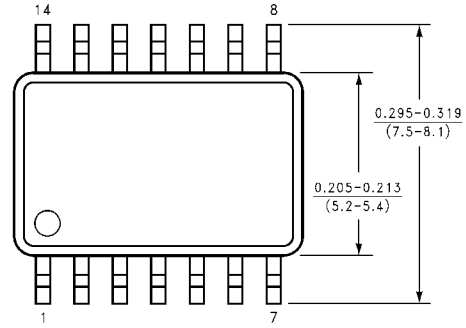

M14D (REV B)

14-Lead Small Outline Package (SOP), EIAJ TYPE II, 5.3mm Wide Package Number M14D

Physical Dimensions inches (millimeters) unless otherwise noted (Continued)



Fairchild does not assume any responsibility for use of any circuitry described, no circuit patent licenses are implied and Fairchild reserves the right at any time without notice to change said circuitry and specifications.

LIFE SUPPORT POLICY

FAIRCHILD'S PRODUCTS ARE NOT AUTHORIZED FOR USE AS CRITICAL COMPONENTS IN LIFE SUPPORT DEVICES OR SYSTEMS WITHOUT THE EXPRESS WRITTEN APPROVAL OF THE PRESIDENT OF FAIRCHILD SEMICONDUCTOR CORPORATION. As used herein:

1. Life support devices or systems are devices or systems which, (a) are intended for surgical implant into the body, or (b) support or sustain life, and (c) whose failure to perform when properly used in accordance with instructions for use provided in the labeling, can be reasonably expected to result in a significant injury to the user.
2. A critical component in any component of a life support device or system whose failure to perform can be reasonably expected to cause the failure of the life support device or system, or to affect its safety or effectiveness.

www.fairchildsemi.com