

74HC132; 74HCT132

Quad 2-input NAND Schmitt trigger

Rev. 4 — 1 December 2015

Product data sheet

1. General description

The 74HC132; 74HCT132 is a quad 2-input NAND gate with Schmitt-trigger inputs. Inputs include clamp diodes. This enables the use of current limiting resistors to interface inputs to voltages in excess of V_{CC} . Schmitt trigger inputs transform slowly changing input signals into sharply defined jitter-free output signals.

2. Features and benefits

- Complies with JEDEC standard no. 7A
- ESD protection:
 - ◆ HBM JESD22-A114F exceeds 2000 V
 - ◆ MM JESD22-A115-A exceeds 200 V
- Multiple package options
- Specified from $-40\text{ }^{\circ}\text{C}$ to $+85\text{ }^{\circ}\text{C}$ and from $-40\text{ }^{\circ}\text{C}$ to $+125\text{ }^{\circ}\text{C}$

3. Applications

- Wave and pulse shapers
- Astable multivibrators
- Monostable multivibrators



4. Ordering information

Table 1. Ordering information

| Type number | Package | | | |
|-------------|-------------------|---------|--|----------|
| | Temperature range | Name | Description | Version |
| 74HC132D | -40 °C to +125 °C | SO14 | plastic small outline package; 14 leads; body width 3.9 mm | SOT108-1 |
| 74HCT132D | | | | |
| 74HC132DB | -40 °C to +125 °C | SSOP14 | plastic shrink small outline package; 14 leads; body width 5.3 mm | SOT337-1 |
| 74HCT132DB | | | | |
| 74HC132PW | -40 °C to +125 °C | TSSOP14 | plastic thin shrink small outline package; 14 leads; body width 4.4 mm | SOT402-1 |
| 74HCT132PW | | | | |

5. Functional diagram

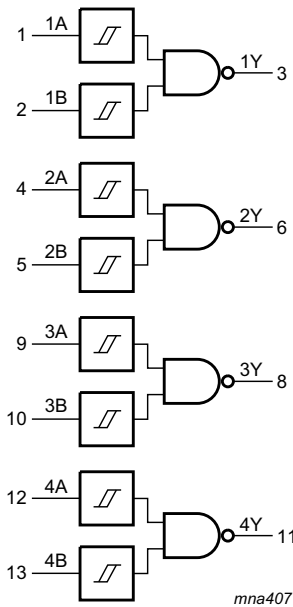

Fig 1. Logic symbol

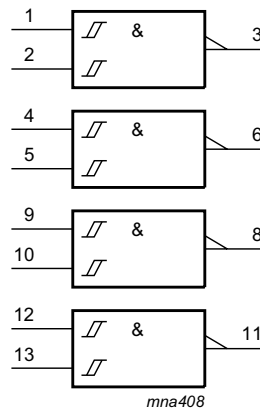

Fig 2. IEC logic symbol

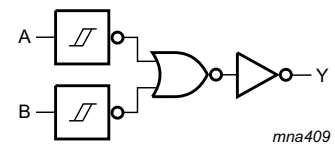

Fig 3. Logic diagram (one Schmitt trigger)

6. Pinning information

6.1 Pinning

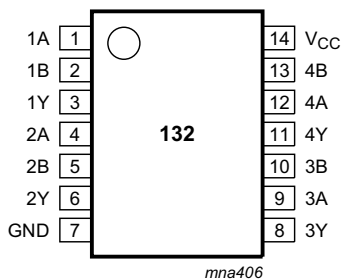

Fig 4. Pin configuration SO14 and (T)SSOP14

6.2 Pin description

Table 2. Pin description

| Symbol | Pin | Description |
|-----------------|--------------|----------------|
| 1A to 4A | 1, 4, 9, 12 | data input |
| 1B to 4B | 2, 5, 10, 13 | data input |
| 1Y to 4Y | 3, 6, 8, 11 | data output |
| GND | 7 | ground (0 V) |
| V _{CC} | 14 | supply voltage |

7. Functional description

Table 3. Function table^[1]

| Input | | Output |
|-------|----|--------|
| nA | nB | nY |
| L | L | H |
| L | H | H |
| H | L | H |
| H | H | L |

[1] H = HIGH voltage level; L = LOW voltage level; X = don't care.

8. Limiting values

Table 4. Limiting values

In accordance with the Absolute Maximum Rating System (IEC 60134). Voltages are referenced to GND (ground = 0 V).

| Symbol | Parameter | Conditions | Min | Max | Unit |
|-----------|-------------------------|--|------|----------|------|
| V_{CC} | supply voltage | | -0.5 | +7 | V |
| I_{IK} | input clamping current | $V_I < -0.5\text{ V}$ or $V_I > V_{CC} + 0.5\text{ V}$ [1] | - | ± 20 | mA |
| I_{OK} | output clamping current | $V_O < -0.5\text{ V}$ or $V_O > V_{CC} + 0.5\text{ V}$ [1] | - | ± 20 | mA |
| I_O | output current | $-0.5\text{ V} < V_O < V_{CC} + 0.5\text{ V}$ | - | ± 25 | mA |
| I_{CC} | supply current | | - | 50 | mA |
| I_{GND} | ground current | | -50 | - | mA |
| T_{stg} | storage temperature | | -65 | +150 | °C |
| P_{tot} | total power dissipation | SO14, and (T)SSOP14 packages [2] | - | 500 | mW |

[1] The input and output voltage ratings may be exceeded if the input and output current ratings are observed.

[2] For SO14 package: P_{tot} derates linearly with 8 mW/K above 70 °C.
For (T)SSOP14 packages: P_{tot} derates linearly with 5.5 mW/K above 60 °C.

9. Recommended operating conditions

Table 5. Recommended operating conditions

Voltages are referenced to GND (ground = 0 V)

| Symbol | Parameter | Conditions | 74HC132 | | | 74HCT132 | | | Unit |
|-----------|---------------------|------------|---------|-----|----------|----------|-----|----------|------|
| | | | Min | Typ | Max | Min | Typ | Max | |
| V_{CC} | supply voltage | | 2.0 | 5.0 | 6.0 | 4.5 | 5.0 | 5.5 | V |
| V_I | input voltage | | 0 | - | V_{CC} | 0 | - | V_{CC} | V |
| V_O | output voltage | | 0 | - | V_{CC} | 0 | - | V_{CC} | V |
| T_{amb} | ambient temperature | | -40 | +25 | +125 | -40 | +25 | +125 | °C |

10. Static characteristics

Table 6. Static characteristics

At recommended operating conditions; voltages are referenced to GND (ground = 0 V).

| Symbol | Parameter | Conditions | 25 °C | | | -40 °C to +85 °C | | -40 °C to +125 °C | | Unit |
|------------------|---------------------------|--|-------|------|------|------------------|------|-------------------|------|------|
| | | | Min | Typ | Max | Min | Max | Min | Max | |
| 74HC132 | | | | | | | | | | |
| V _{OH} | HIGH-level output voltage | V _I = V _{T+} or V _{T-} | | | | | | | | |
| | | I _O = -20 μA; V _{CC} = 2.0 V | 1.9 | 2.0 | - | 1.9 | - | 1.9 | - | V |
| | | I _O = -20 μA; V _{CC} = 4.5 V | 4.4 | 4.5 | - | 4.4 | - | 4.4 | - | V |
| | | I _O = -20 μA; V _{CC} = 6.0 V | 5.9 | 6.0 | - | 5.9 | - | 5.9 | - | V |
| | | I _O = -4.0 mA; V _{CC} = 4.5 V | 3.98 | 4.32 | - | 3.84 | - | 3.7 | - | V |
| | | I _O = -5.2 mA; V _{CC} = 6.0 V | 5.48 | 5.81 | - | 5.34 | - | 5.2 | - | V |
| V _{OL} | LOW-level output voltage | V _I = V _{T+} or V _{T-} | | | | | | | | |
| | | I _O = 20 μA; V _{CC} = 2.0 V | - | 0 | 0.1 | - | 0.1 | - | 0.1 | V |
| | | I _O = 20 μA; V _{CC} = 4.5 V | - | 0 | 0.1 | - | 0.1 | - | 0.1 | V |
| | | I _O = 20 μA; V _{CC} = 6.0 V | - | 0 | 0.1 | - | 0.1 | - | 0.1 | V |
| | | I _O = 4.0 mA; V _{CC} = 4.5 V | - | 0.15 | 0.26 | - | 0.33 | - | 0.4 | V |
| | | I _O = 5.2 mA; V _{CC} = 6.0 V | - | 0.16 | 0.26 | - | 0.33 | - | 0.4 | V |
| I _I | input leakage current | V _I = V _{CC} or GND; V _{CC} = 6.0 V | - | - | ±0.1 | - | ±1.0 | - | ±1.0 | μA |
| I _{CC} | supply current | V _I = V _{CC} or GND; I _O = 0 A; V _{CC} = 6.0 V | - | - | 2.0 | - | 20 | - | 40 | μA |
| C _I | input capacitance | | - | 3.5 | - | - | - | - | - | pF |
| 74HCT132 | | | | | | | | | | |
| V _{OH} | HIGH-level output voltage | V _I = V _{T+} or V _{T-} ; V _{CC} = 4.5 V | | | | | | | | |
| | | I _O = -20 μA | 4.4 | 4.5 | - | 4.4 | - | 4.4 | - | V |
| | | I _O = -4.0 mA | 3.98 | 4.32 | - | 3.84 | - | 3.7 | - | V |
| V _{OL} | LOW-level output voltage | V _I = V _{T+} or V _{T-} ; V _{CC} = 4.5 V | | | | | | | | |
| | | I _O = 20 μA; | - | 0 | 0.1 | - | 0.1 | - | 0.1 | V |
| | | I _O = 4.0 mA; | - | 0.15 | 0.26 | - | 0.33 | - | 0.4 | V |
| I _I | input leakage current | V _I = V _{CC} or GND; V _{CC} = 5.5 V | - | - | ±0.1 | - | ±1.0 | - | ±1.0 | μA |
| I _{CC} | supply current | V _I = V _{CC} or GND; I _O = 0 A; V _{CC} = 5.5 V | - | - | 2.0 | - | 20 | - | 40 | μA |
| ΔI _{CC} | additional supply current | per input pin; V _I = V _{CC} - 2.1 V; I _O = 0 A; other inputs at V _{CC} or GND; V _{CC} = 4.5 V to 5.5 V | - | 30 | 108 | - | 135 | - | 147 | μA |
| C _I | input capacitance | | - | 3.5 | - | - | - | - | - | pF |

11. Dynamic characteristics

Table 7. Dynamic characteristics

$GND = 0\text{ V}$; $C_L = 50\text{ pF}$; for load circuit see [Figure 6](#).

| Symbol | Parameter | Conditions | 25 °C | | | -40 °C to +125 °C | | Unit |
|-----------------|-------------------------------|--|-------|-----|-----|-------------------|--------------|------|
| | | | Min | Typ | Max | Max (85 °C) | Max (125 °C) | |
| 74HC132 | | | | | | | | |
| t_{pd} | propagation delay | nA, nB to nY; see Figure 5 [1] | | | | | | |
| | | $V_{CC} = 2.0\text{ V}$ | - | 36 | 125 | 155 | 190 | ns |
| | | $V_{CC} = 4.5\text{ V}$ | - | 13 | 25 | 31 | 38 | ns |
| | | $V_{CC} = 5.0\text{ V}$; $C_L = 15\text{ pF}$ | - | 11 | - | - | - | ns |
| | | $V_{CC} = 6.0\text{ V}$ | - | 10 | 21 | 26 | 32 | ns |
| t_t | transition time | see Figure 5 [2] | | | | | | |
| | | $V_{CC} = 2.0\text{ V}$ | - | 19 | 75 | 95 | 110 | ns |
| | | $V_{CC} = 4.5\text{ V}$ | - | 7 | 15 | 19 | 22 | ns |
| | | $V_{CC} = 6.0\text{ V}$ | - | 6 | 13 | 16 | 19 | ns |
| C_{PD} | power dissipation capacitance | per package; $V_I = GND$ to V_{CC} [3] | - | 24 | - | - | - | pF |
| 74HCT132 | | | | | | | | |
| t_{pd} | propagation delay | nA, nB to nY; see Figure 5 [1] | | | | | | |
| | | $V_{CC} = 4.5\text{ V}$ | - | 20 | 33 | 41 | 50 | ns |
| | | $V_{CC} = 5.0\text{ V}$; $C_L = 15\text{ pF}$ | - | 17 | - | - | - | ns |
| t_t | transition time | $V_{CC} = 4.5\text{ V}$; see Figure 5 [2] | - | 7 | 15 | 19 | 22 | ns |
| C_{PD} | power dissipation capacitance | per package; $V_I = GND$ to $V_{CC} - 1.5\text{ V}$ [3] | - | 20 | - | - | - | pF |

[1] t_{pd} is the same as t_{PHL} and t_{PLH} .

[2] t_t is the same as t_{THL} and t_{TLH} .

[3] C_{PD} is used to determine the dynamic power dissipation (P_D in μW):

$$P_D = C_{PD} \times V_{CC}^2 \times f_i \times N + \sum (C_L \times V_{CC}^2 \times f_o) \text{ where:}$$

f_i = input frequency in MHz;

f_o = output frequency in MHz;

C_L = output load capacitance in pF;

V_{CC} = supply voltage in V;

N = number of inputs switching;

$\sum (C_L \times V_{CC}^2 \times f_o)$ = sum of outputs.

12. Waveforms

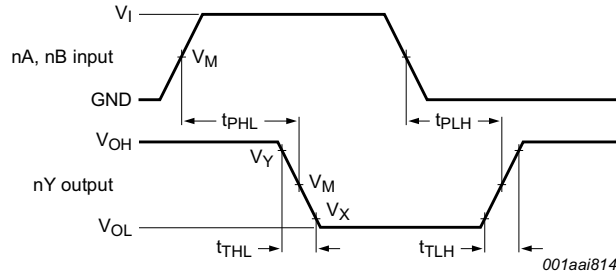

Measurement points are given in [Table 8](#).
 V_{OL} and V_{OH} are typical voltage output levels that occur with the output load.

Fig 5. Input to output propagation delays

Table 8. Measurement points

| Type | Input | Output | | |
|----------|-------------|-------------|-------------|-------------|
| | V_M | V_M | V_X | V_Y |
| 74HC132 | $0.5V_{CC}$ | $0.5V_{CC}$ | $0.1V_{CC}$ | $0.9V_{CC}$ |
| 74HCT132 | 1.3 V | 1.3 V | $0.1V_{CC}$ | $0.9V_{CC}$ |

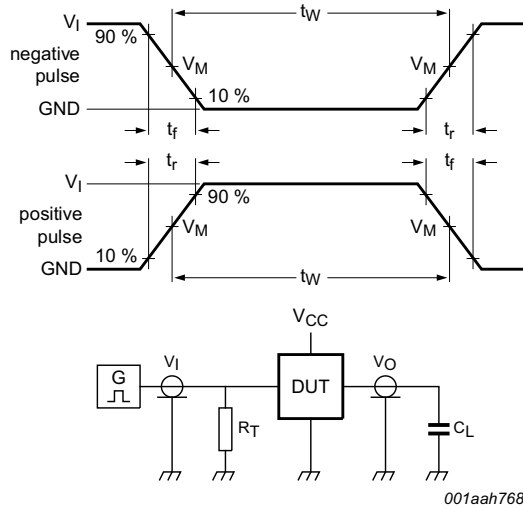

Test data is given in [Table 9](#).
 Definitions test circuit:
 R_T = termination resistance should be equal to output impedance Z_o of the pulse generator.
 C_L = load capacitance including jig and probe capacitance.

Fig 6. Test circuit for measuring switching times

Table 9. Test data

| Type | Input | | Load | Test |
|----------|----------|------------|--------------|--------------------|
| | V_I | t_r, t_f | C_L | |
| 74HC132 | V_{CC} | 6.0 ns | 15 pF, 50 pF | t_{PLH}, t_{PHL} |
| 74HCT132 | 3.0 V | 6.0 ns | 15 pF, 50 pF | t_{PLH}, t_{PHL} |

13. Transfer characteristics

Table 10. Transfer characteristics

At recommended operating conditions; voltages are referenced to GND (ground = 0 V); see Figure 7 and Figure 8.

| Symbol | Parameter | Conditions | $T_{amb} = 25\text{ }^\circ\text{C}$ | | | $T_{amb} = -40\text{ }^\circ\text{C}$ to $+85\text{ }^\circ\text{C}$ | | $T_{amb} = -40\text{ }^\circ\text{C}$ to $+125\text{ }^\circ\text{C}$ | | Unit |
|-----------------|----------------------------------|-------------------------|--------------------------------------|------|------|---|------|--|------|------|
| | | | Min | Typ | Max | Min | Max | Min | Max | |
| 74HC132 | | | | | | | | | | |
| V_{T+} | positive-going threshold voltage | $V_{CC} = 2.0\text{ V}$ | 0.7 | 1.18 | 1.5 | 0.7 | 1.5 | 0.7 | 1.5 | V |
| | | $V_{CC} = 4.5\text{ V}$ | 1.7 | 2.38 | 3.15 | 1.7 | 3.15 | 1.7 | 3.15 | V |
| | | $V_{CC} = 6.0\text{ V}$ | 2.1 | 3.14 | 4.2 | 2.1 | 4.2 | 2.1 | 4.2 | V |
| V_{T-} | negative-going threshold voltage | $V_{CC} = 2.0\text{ V}$ | 0.3 | 0.63 | 1.0 | 0.3 | 1.0 | 0.3 | 1.0 | V |
| | | $V_{CC} = 4.5\text{ V}$ | 0.9 | 1.67 | 2.2 | 0.9 | 2.2 | 0.9 | 2.2 | V |
| | | $V_{CC} = 6.0\text{ V}$ | 1.2 | 2.26 | 3.0 | 1.2 | 3.0 | 1.2 | 3.0 | V |
| V_H | hysteresis voltage | $V_{CC} = 2.0\text{ V}$ | 0.2 | 0.55 | 1.0 | 0.2 | 1.0 | 0.2 | 1.0 | V |
| | | $V_{CC} = 4.5\text{ V}$ | 0.4 | 0.71 | 1.4 | 0.4 | 1.4 | 0.4 | 1.4 | V |
| | | $V_{CC} = 6.0\text{ V}$ | 0.6 | 0.88 | 1.6 | 0.6 | 1.6 | 0.6 | 1.6 | V |
| 74HCT132 | | | | | | | | | | |
| V_{T+} | positive-going threshold voltage | $V_{CC} = 4.5\text{ V}$ | 1.2 | 1.41 | 1.9 | 1.2 | 1.9 | 1.2 | 1.9 | V |
| | | $V_{CC} = 5.5\text{ V}$ | 1.4 | 1.59 | 2.1 | 1.4 | 2.1 | 1.4 | 2.1 | V |
| V_{T-} | negative-going threshold voltage | $V_{CC} = 4.5\text{ V}$ | 0.5 | 0.85 | 1.2 | 0.5 | 1.2 | 0.5 | 1.2 | V |
| | | $V_{CC} = 5.5\text{ V}$ | 0.6 | 0.99 | 1.4 | 0.6 | 1.4 | 0.6 | 1.4 | V |
| V_H | hysteresis voltage | $V_{CC} = 4.5\text{ V}$ | 0.4 | 0.56 | - | 0.4 | - | 0.4 | - | V |
| | | $V_{CC} = 5.5\text{ V}$ | 0.4 | 0.60 | - | 0.4 | - | 0.4 | - | V |

14. Transfer characteristics waveforms

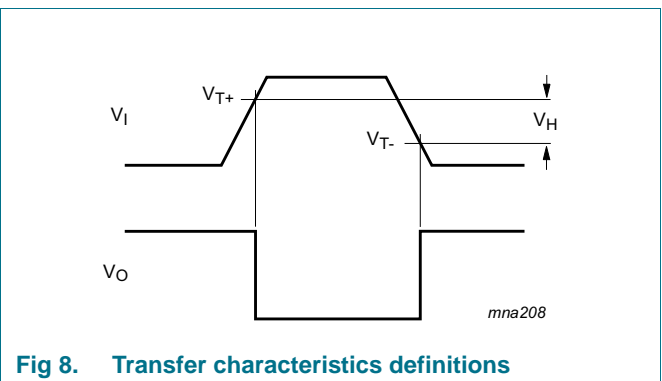
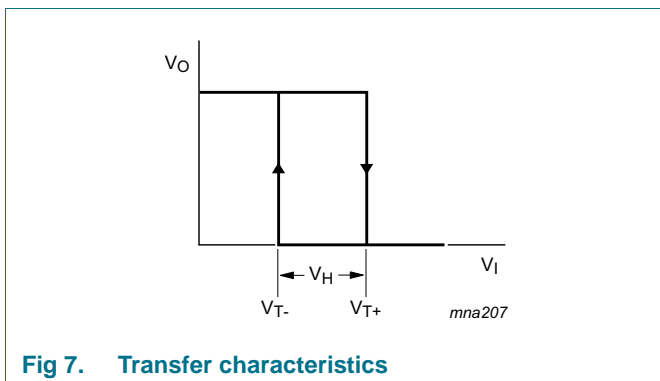

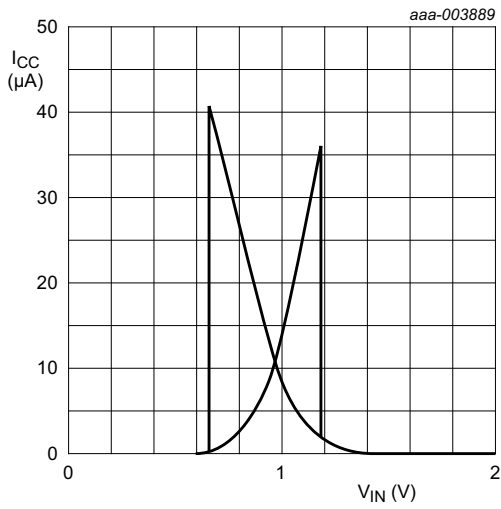

a. $V_{CC} = 2.0\text{ V}$

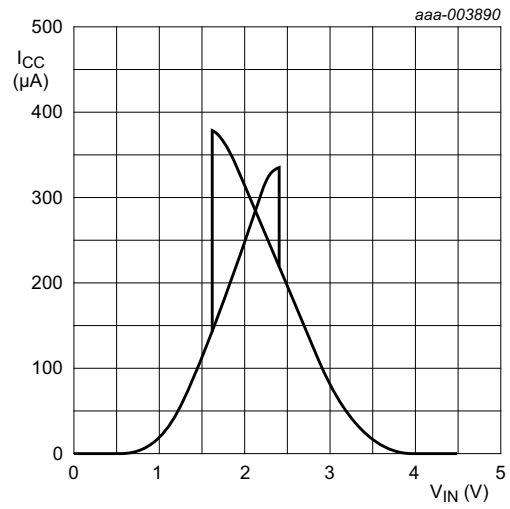

b. $V_{CC} = 4.5\text{ V}$

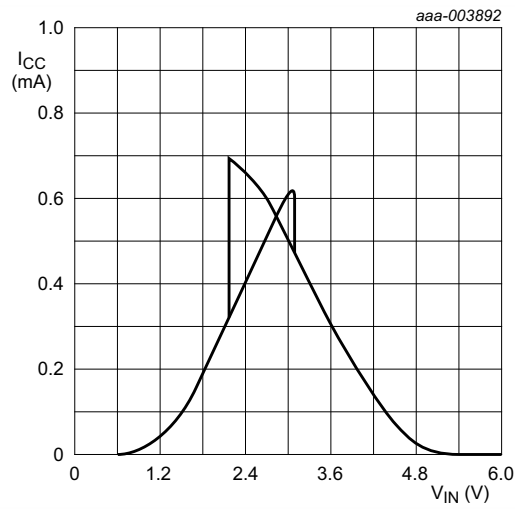

c. $V_{CC} = 6.0\text{ V}$

Fig 9. Typical 74HC132 transfer characteristics

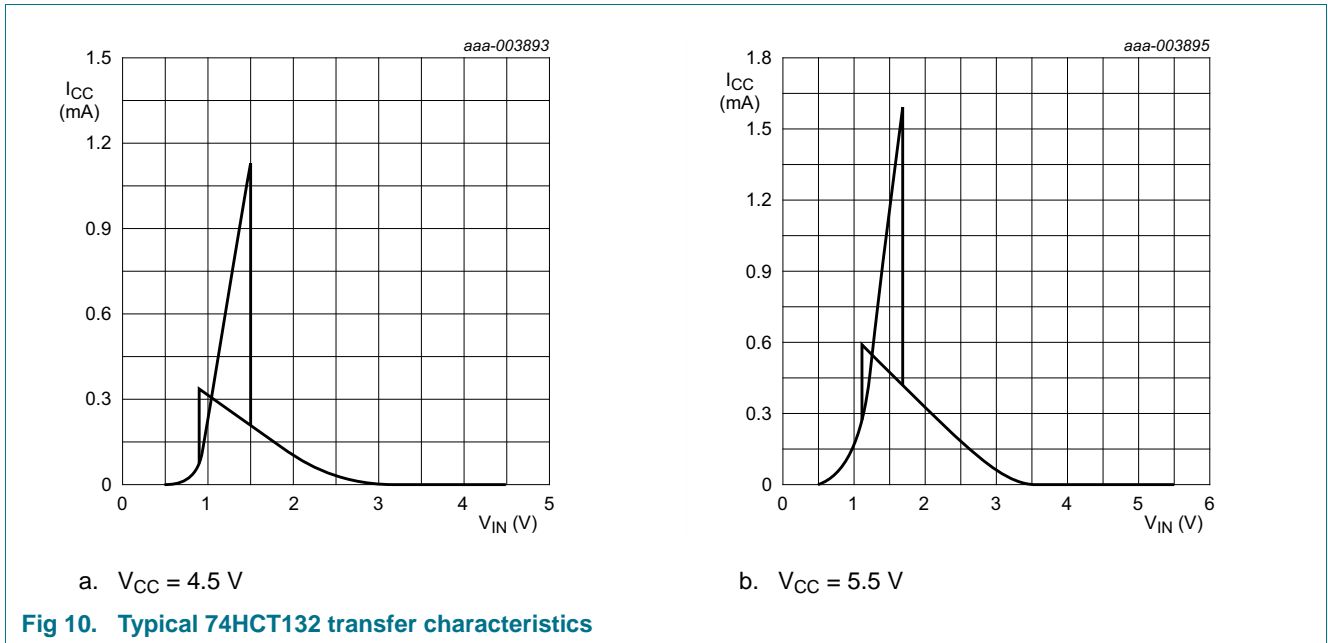

15. Application information

The slow input rise and fall times cause additional power dissipation, this can be calculated using the following formula:

$$P_{\text{add}} = f_i \times (t_r \times \Delta I_{\text{CC(AV)}} + t_f \times \Delta I_{\text{CC(AV)}}) \times V_{\text{CC}} \text{ where:}$$

P_{add} = additional power dissipation (μW);

f_i = input frequency (MHz);

t_r = rise time (ns); 10 % to 90 %;

t_f = fall time (ns); 90 % to 10 %;

$\Delta I_{\text{CC(AV)}}$ = average additional supply current (μA).

Average $\Delta I_{\text{CC(AV)}}$ differs with positive or negative input transitions, as shown in [Figure 11](#) and [Figure 12](#).

An example of a relaxation circuit using the 74HC132; 74HCT132 is shown in [Figure 13](#).

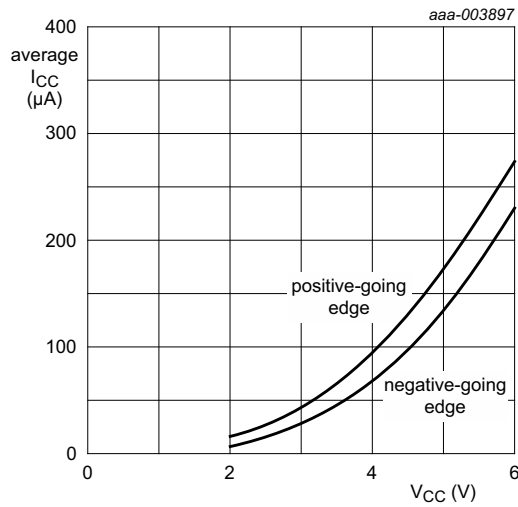

- (1) Positive-going edge.
- (2) Negative-going edge.

Fig 11. Average additional supply current as a function of V_{CC} for 74HC132; linear change of V_I between 0.1V_{CC} to 0.9V_{CC}.

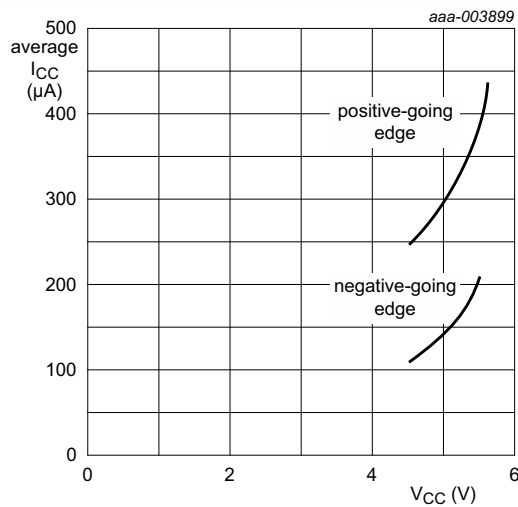

- (1) Positive-going edge.
- (2) Negative-going edge.

Fig 12. Average additional supply current as a function of V_{CC} for 74HCT132; linear change of V_I between 0.1V_{CC} to 0.9V_{CC}.

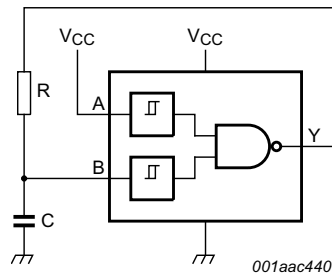

For 74HC132 and 74HCT132: $f = \frac{1}{T} \approx \frac{1}{K \times RC}$

For K-factor, see [Figure 14](#)

Fig 13. Relaxation oscillator

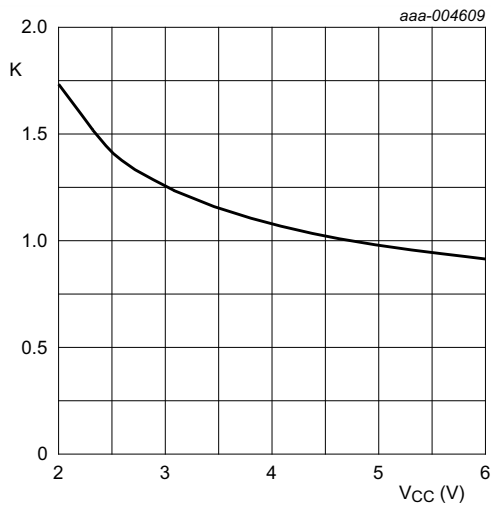

K-factor for 74HC132

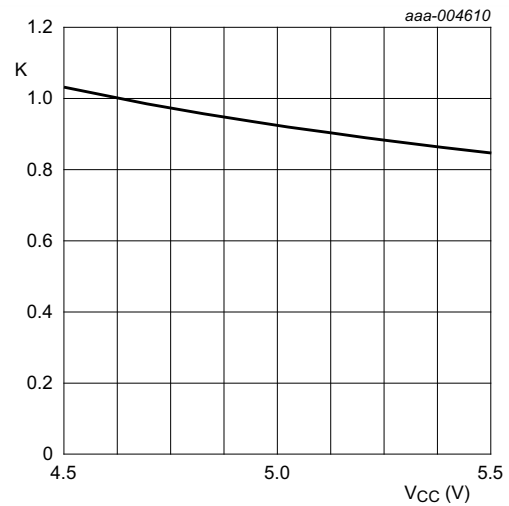

K-factor for 74HCT132

Fig 14. Typical K-factor for relaxation oscillator

16. Package outline

SO14: plastic small outline package; 14 leads; body width 3.9 mm

SOT108-1

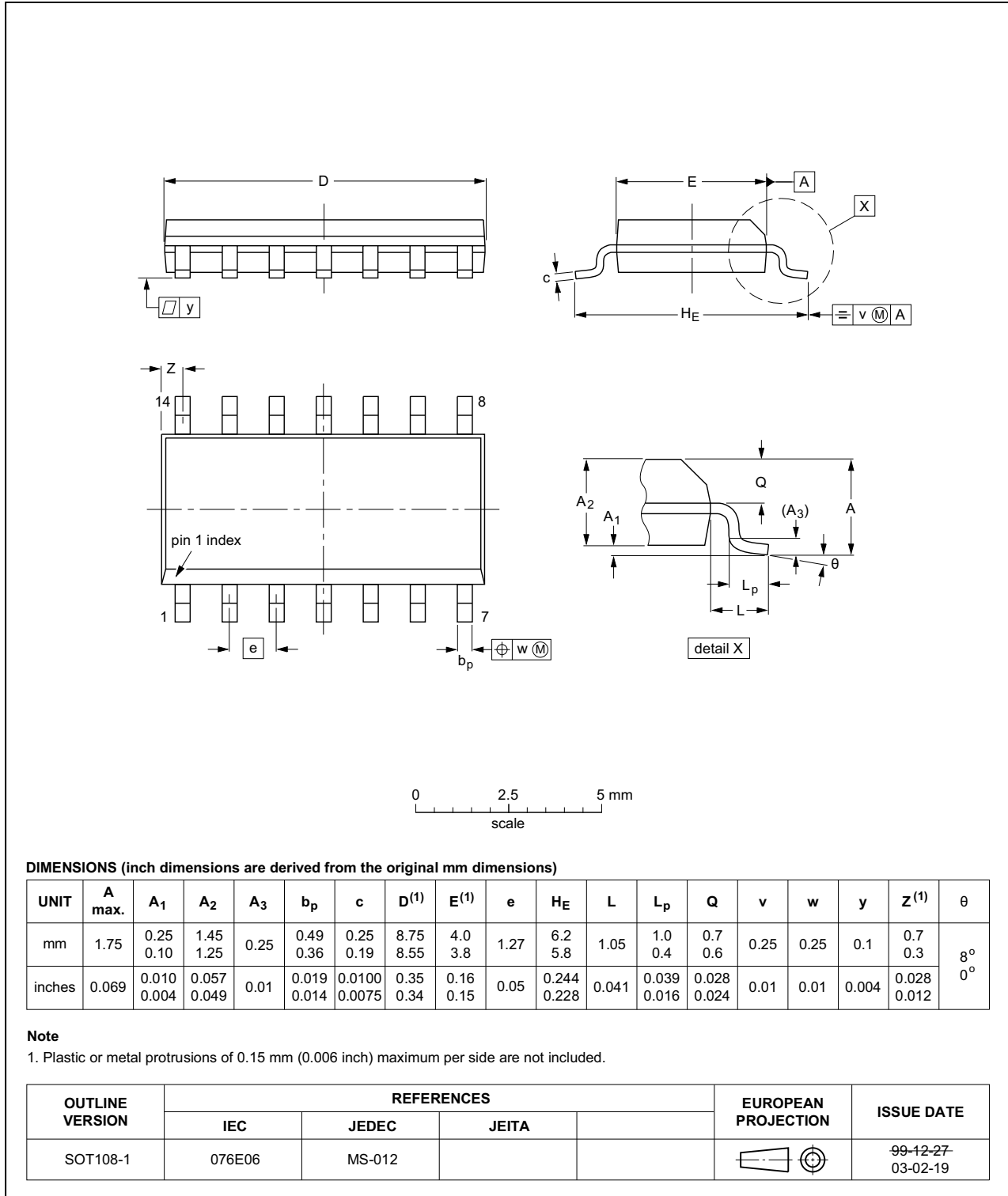

Fig 15. Package outline SOT108-1 (SO14)

SSOP14: plastic shrink small outline package; 14 leads; body width 5.3 mm

SOT337-1

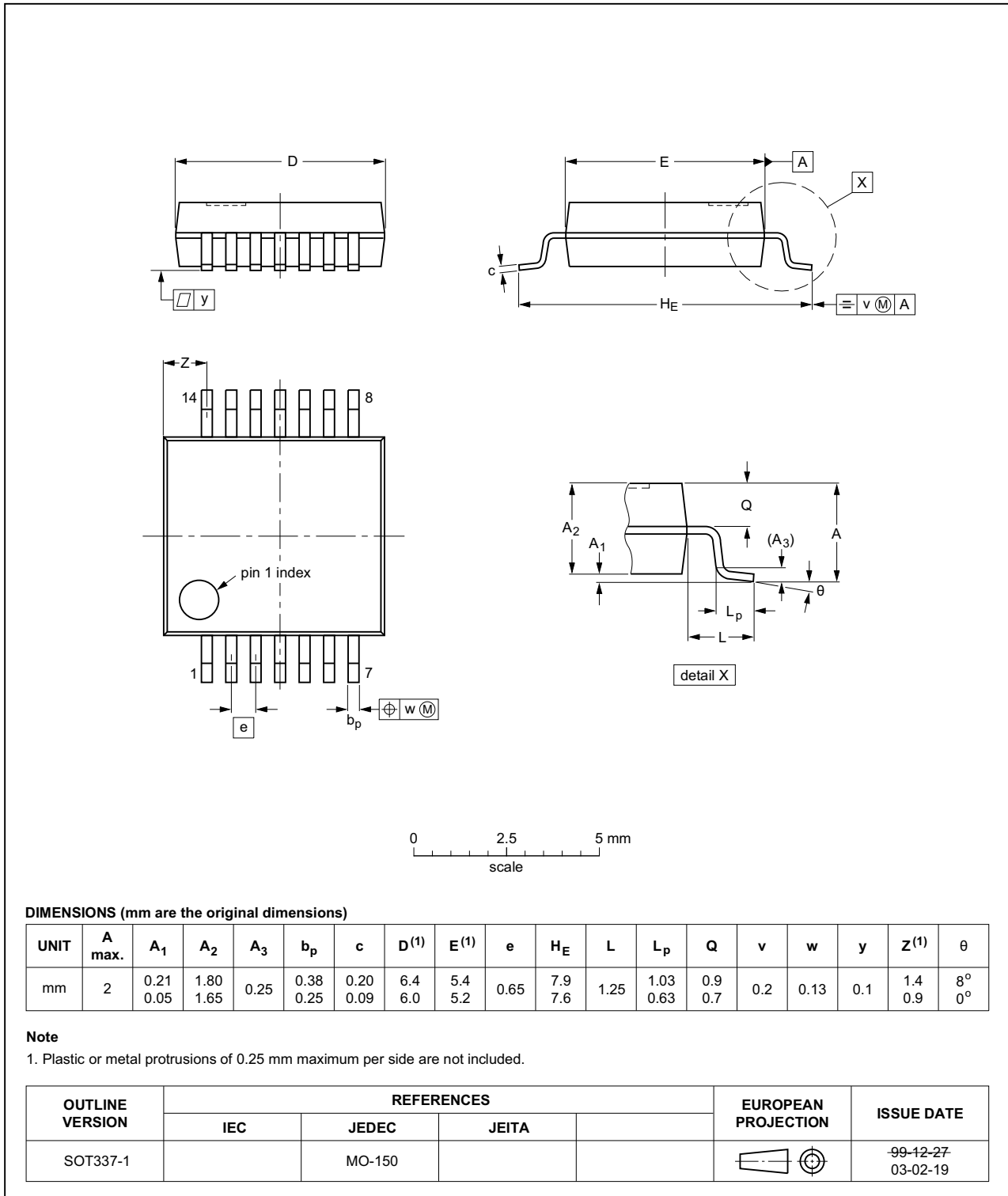

Fig 16. Package outline SOT337-1 (SSOP14)

TSSOP14: plastic thin shrink small outline package; 14 leads; body width 4.4 mm

SOT402-1

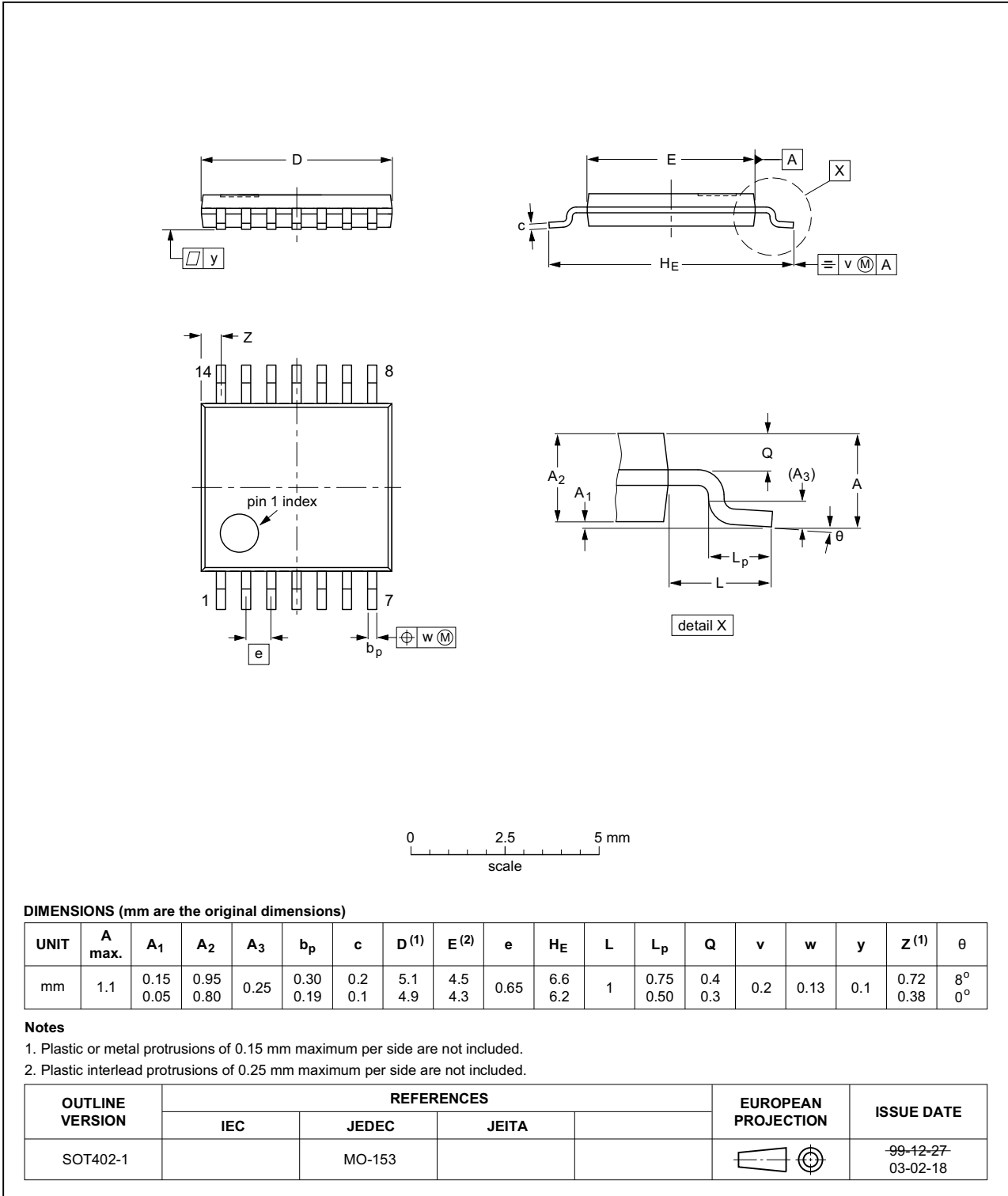

Fig 17. Package outline SOT402-1 (TSSOP14)

17. Abbreviations

Table 11. Abbreviations

| Acronym | Description |
|---------|---|
| CMOS | Complementary Metal-Oxide Semiconductor |
| DUT | Device Under Test |
| ESD | ElectroStatic Discharge |
| HBM | Human Body Model |
| MM | Machine Model |
| TTL | Transistor-Transistor Logic |

18. Revision history

Table 12. Revision history

| Document ID | Release date | Data sheet status | Change notice | Supersedes |
|---------------------|--|-----------------------|---------------|---------------------|
| 74HC_HCT132 v.4 | 20151201 | Product data sheet | - | 74HC_HCT132 v.3 |
| Modifications: | <ul style="list-style-type: none"> Type numbers 74HC132N and 74HCT132N (SOT27-1) removed. | | | |
| 74HC_HCT132 v.3 | 20120830 | Product data sheet | - | 74HC_HCT132_CNV v.2 |
| Modifications: | <ul style="list-style-type: none"> The format of this data sheet has been redesigned to comply with the new identity guidelines of NXP Semiconductors. Legal texts have been adapted to the new company name where appropriate. Figure 14 added (typical K-factor for relaxation oscillator). | | | |
| 74HC_HCT132_CNV v.2 | 19970826 | Product specification | - | - |

19. Legal information

19.1 Data sheet status

| Document status ^{[1][2]} | Product status ^[3] | Definition |
|-----------------------------------|-------------------------------|---|
| Objective [short] data sheet | Development | This document contains data from the objective specification for product development. |
| Preliminary [short] data sheet | Qualification | This document contains data from the preliminary specification. |
| Product [short] data sheet | Production | This document contains the product specification. |

[1] Please consult the most recently issued document before initiating or completing a design.

[2] The term 'short data sheet' is explained in section "Definitions".

[3] The product status of device(s) described in this document may have changed since this document was published and may differ in case of multiple devices. The latest product status information is available on the Internet at URL <http://www.nxp.com>.

19.2 Definitions

Draft — The document is a draft version only. The content is still under internal review and subject to formal approval, which may result in modifications or additions. NXP Semiconductors does not give any representations or warranties as to the accuracy or completeness of information included herein and shall have no liability for the consequences of use of such information.

Short data sheet — A short data sheet is an extract from a full data sheet with the same product type number(s) and title. A short data sheet is intended for quick reference only and should not be relied upon to contain detailed and full information. For detailed and full information see the relevant full data sheet, which is available on request via the local NXP Semiconductors sales office. In case of any inconsistency or conflict with the short data sheet, the full data sheet shall prevail.

Product specification — The information and data provided in a Product data sheet shall define the specification of the product as agreed between NXP Semiconductors and its customer, unless NXP Semiconductors and customer have explicitly agreed otherwise in writing. In no event however, shall an agreement be valid in which the NXP Semiconductors product is deemed to offer functions and qualities beyond those described in the Product data sheet.

19.3 Disclaimers

Limited warranty and liability — Information in this document is believed to be accurate and reliable. However, NXP Semiconductors does not give any representations or warranties, expressed or implied, as to the accuracy or completeness of such information and shall have no liability for the consequences of use of such information. NXP Semiconductors takes no responsibility for the content in this document if provided by an information source outside of NXP Semiconductors.

In no event shall NXP Semiconductors be liable for any indirect, incidental, punitive, special or consequential damages (including - without limitation - lost profits, lost savings, business interruption, costs related to the removal or replacement of any products or rework charges) whether or not such damages are based on tort (including negligence), warranty, breach of contract or any other legal theory.

Notwithstanding any damages that customer might incur for any reason whatsoever, NXP Semiconductors' aggregate and cumulative liability towards customer for the products described herein shall be limited in accordance with the *Terms and conditions of commercial sale* of NXP Semiconductors.

Right to make changes — NXP Semiconductors reserves the right to make changes to information published in this document, including without limitation specifications and product descriptions, at any time and without notice. This document supersedes and replaces all information supplied prior to the publication hereof.

Suitability for use — NXP Semiconductors products are not designed, authorized or warranted to be suitable for use in life support, life-critical or safety-critical systems or equipment, nor in applications where failure or malfunction of an NXP Semiconductors product can reasonably be expected to result in personal injury, death or severe property or environmental damage. NXP Semiconductors and its suppliers accept no liability for inclusion and/or use of NXP Semiconductors products in such equipment or applications and therefore such inclusion and/or use is at the customer's own risk.

Applications — Applications that are described herein for any of these products are for illustrative purposes only. NXP Semiconductors makes no representation or warranty that such applications will be suitable for the specified use without further testing or modification.

Customers are responsible for the design and operation of their applications and products using NXP Semiconductors products, and NXP Semiconductors accepts no liability for any assistance with applications or customer product design. It is customer's sole responsibility to determine whether the NXP Semiconductors product is suitable and fit for the customer's applications and products planned, as well as for the planned application and use of customer's third party customer(s). Customers should provide appropriate design and operating safeguards to minimize the risks associated with their applications and products.

NXP Semiconductors does not accept any liability related to any default, damage, costs or problem which is based on any weakness or default in the customer's applications or products, or the application or use by customer's third party customer(s). Customer is responsible for doing all necessary testing for the customer's applications and products using NXP Semiconductors products in order to avoid a default of the applications and the products or of the application or use by customer's third party customer(s). NXP does not accept any liability in this respect.

Limiting values — Stress above one or more limiting values (as defined in the Absolute Maximum Ratings System of IEC 60134) will cause permanent damage to the device. Limiting values are stress ratings only and (proper) operation of the device at these or any other conditions above those given in the Recommended operating conditions section (if present) or the Characteristics sections of this document is not warranted. Constant or repeated exposure to limiting values will permanently and irreversibly affect the quality and reliability of the device.

Terms and conditions of commercial sale — NXP Semiconductors products are sold subject to the general terms and conditions of commercial sale, as published at <http://www.nxp.com/profile/terms>, unless otherwise agreed in a valid written individual agreement. In case an individual agreement is concluded only the terms and conditions of the respective agreement shall apply. NXP Semiconductors hereby expressly objects to applying the customer's general terms and conditions with regard to the purchase of NXP Semiconductors products by customer.

No offer to sell or license — Nothing in this document may be interpreted or construed as an offer to sell products that is open for acceptance or the grant, conveyance or implication of any license under any copyrights, patents or other industrial or intellectual property rights.

Export control — This document as well as the item(s) described herein may be subject to export control regulations. Export might require a prior authorization from competent authorities.

Non-automotive qualified products — Unless this data sheet expressly states that this specific NXP Semiconductors product is automotive qualified, the product is not suitable for automotive use. It is neither qualified nor tested in accordance with automotive testing or application requirements. NXP Semiconductors accepts no liability for inclusion and/or use of non-automotive qualified products in automotive equipment or applications.

In the event that customer uses the product for design-in and use in automotive applications to automotive specifications and standards, customer (a) shall use the product without NXP Semiconductors' warranty of the product for such automotive applications, use and specifications, and (b) whenever customer uses the product for automotive applications beyond

NXP Semiconductors' specifications such use shall be solely at customer's own risk, and (c) customer fully indemnifies NXP Semiconductors for any liability, damages or failed product claims resulting from customer design and use of the product for automotive applications beyond NXP Semiconductors' standard warranty and NXP Semiconductors' product specifications.

Translations — A non-English (translated) version of a document is for reference only. The English version shall prevail in case of any discrepancy between the translated and English versions.

19.4 Trademarks

Notice: All referenced brands, product names, service names and trademarks are the property of their respective owners.

20. Contact information

For more information, please visit: <http://www.nxp.com>

For sales office addresses, please send an email to: salesaddresses@nxp.com

21. Contents

| | | |
|-----------|---|-----------|
| 1 | General description | 1 |
| 2 | Features and benefits | 1 |
| 3 | Applications | 1 |
| 4 | Ordering information | 2 |
| 5 | Functional diagram | 2 |
| 6 | Pinning information | 3 |
| 6.1 | Pinning | 3 |
| 6.2 | Pin description | 3 |
| 7 | Functional description | 3 |
| 8 | Limiting values | 4 |
| 9 | Recommended operating conditions | 4 |
| 10 | Static characteristics | 5 |
| 11 | Dynamic characteristics | 6 |
| 12 | Waveforms | 7 |
| 13 | Transfer characteristics | 8 |
| 14 | Transfer characteristics waveforms | 8 |
| 15 | Application information | 10 |
| 16 | Package outline | 13 |
| 17 | Abbreviations | 16 |
| 18 | Revision history | 16 |
| 19 | Legal information | 17 |
| 19.1 | Data sheet status | 17 |
| 19.2 | Definitions | 17 |
| 19.3 | Disclaimers | 17 |
| 19.4 | Trademarks | 18 |
| 20 | Contact information | 18 |
| 21 | Contents | 19 |

Please be aware that important notices concerning this document and the product(s) described herein, have been included in section 'Legal information'.

© NXP Semiconductors N.V. 2015. All rights reserved.

For more information, please visit: <http://www.nxp.com>
 For sales office addresses, please send an email to: salesaddresses@nxp.com

Date of release: 1 December 2015
 Document identifier: 74HC_HCT132