HD74HC298

Quad. 2-input Multiplexers (with storage)

HITACHI



Description

This circuit is controlled by the signals word select and clock. When the word select input is taken low word 1 (A_1 , B_1 , C_1 and D_1) is presented to the inputs of the flip-flops, and when word select is high word 2 (A_2 , B_2 , C_2 and D_2) is presented to the inputs of the flip-flops. The selected word is clocked to the output terminals on the negative edge of the clock pulse.

Features

- High Speed Operation: t_{pd} (Clock to Q) = 19 ns typ ($C_L = 50$ pF)
- High Output Current: Fanout of 10 LSTTL Loads
- Wide Operating Voltage: $V_{CC} = 2$ to 6 V
- Low Input Current: 1 μ A max
- Low Quiescent Supply Current: I_{CC} (static) = 4 μ A max

Function Table

Inputs		Outputs			
Word Select	Clock	Q_A	Q_B	Q_C	Q_D
L		a_1	b_1	c_1	d_1
H		a_2	b_2	c_2	d_2
X	H	Q_{A0}	Q_{B0}	Q_{C0}	Q_{D0}

HD74HC298

Pin Arrangement

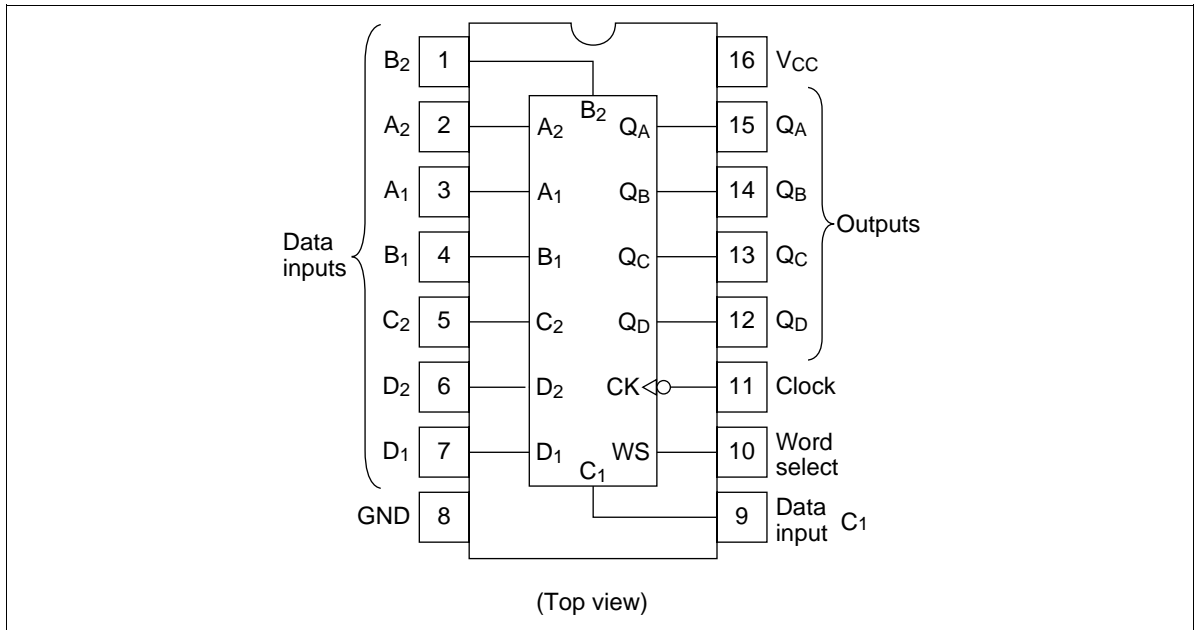

DC Characteristics

Item	Symbol	V _{CC} (V)	Ta = 25°C			Ta = -40 to +85°C		Unit	Test Conditions	
			Min	Typ	Max	Min	Max			
Input voltage	V _{IH}	2.0	1.5	—	—	1.5	—	V		
		4.5	3.15	—	—	3.15	—			
		6.0	4.2	—	—	4.2	—			
	V _{IL}	2.0	—	—	0.5	—	0.5			V
		4.5	—	—	1.35	—	1.35			
		6.0	—	—	1.8	—	1.8			
Output voltage	V _{OH}	2.0	1.9	2.0	—	1.9	—	V	Vin = V _{IH} or V _{IL} I _{OH} = -20 μA	
		4.5	4.4	4.5	—	4.4	—			
		6.0	5.9	6.0	—	5.9	—			
		4.5	4.18	—	—	4.13	—			I _{OH} = -4 mA
		6.0	5.68	—	—	5.63	—			I _{OH} = -5.2 mA
	V _{OL}	2.0	—	0.0	0.1	—	0.1	V	Vin = V _{IH} or V _{IL} I _{OL} = 20 μA	
		4.5	—	0.0	0.1	—	0.1			
		6.0	—	0.0	0.1	—	0.1			
		4.5	—	—	0.26	—	0.33			I _{OL} = 4 mA
		6.0	—	—	0.26	—	0.33			I _{OL} = 5.2 mA
Input current	I _{in}	6.0	—	—	±0.1	—	±1.0	μA	Vin = V _{CC} or GND	
Quiescent supply current	I _{CC}	6.0	—	—	4.0	—	40	μA	Vin = V _{CC} or GND, I _{out} = 0 μA	

HD74HC298

AC Characteristics ($C_L = 50$ pF, Input $t_r = t_f = 6$ ns)

Item	Symbol	V_{CC} (V)	Ta = 25°C		Ta = -40 to +85°C		Unit	Test Conditions	
			Min	Typ	Max	Min			Max
Propagation delay time	t_{PLH}	2.0	—	—	170	—	215	ns	Clock to Q
	t_{PHL}	4.5	—	19	34	—	43		
		6.0	—	—	29	—	37		
Pulse width	t_w	2.0	80	—	—	100	—	ns	Clock
		4.5	16	10	—	20	—		
		6.0	14	—	—	17	—		
Setup time	t_{su}	2.0	150	—	—	190	—	ns	
		4.5	30	16	—	38	—		
		6.0	26	—	—	33	—		
Hold time	t_h	2.0	5	—	—	5	—	ns	
		4.5	5	-5	—	5	—		
		6.0	5	—	—	5	—		
Output rise/fall time	t_{TLH}	2.0	—	—	75	—	95	ns	
	t_{THL}	4.5	—	5	15	—	19		
		6.0	—	—	13	—	16		
Input capacitance	C_{in}	—	—	5	10	—	10	pF	

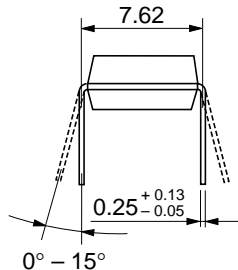
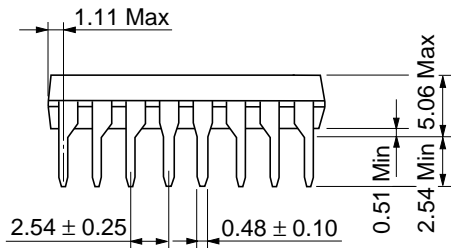
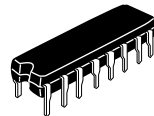
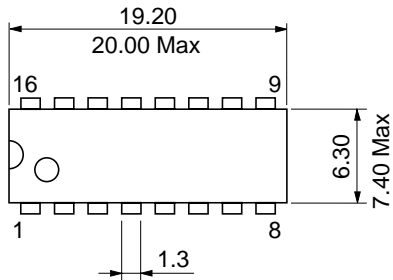

Hitachi Code	DP-16
JEDEC	Conforms
EIAJ	Conforms
Weight (reference value)	1.07 g

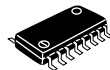

*Dimension including the plating thickness
Base material dimension

Hitachi Code	FP-16DA
JEDEC	—
EIAJ	Conforms
Weight (reference value)	0.24 g



*Dimension including the plating thickness
Base material dimension

Hitachi Code	FP-16DN
JEDEC	Conforms
EIAJ	Conforms
Weight (reference value)	0.15 g