

## 74LCX157

# Low Voltage Quad 2-Input Multiplexer with 5V Tolerant Inputs

### General Description

The LCX157 is a high-speed quad 2-input multiplexer. Four bits of data from two sources can be selected using the common Select and Enable inputs. The four outputs present the selected data in the true (noninverted) form. The LCX157 can also be used as a function generator.

The 74LCX157 is fabricated with advanced CMOS technology to achieve high speed operation while maintaining CMOS low power dissipation.

### Features

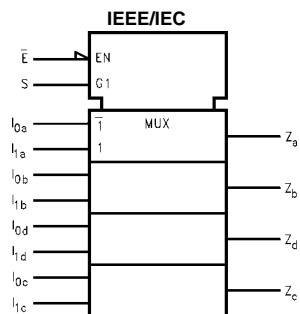
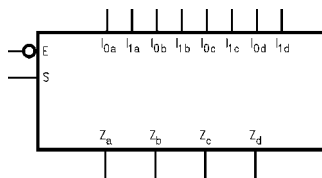
- 5V tolerant inputs
- 2.3V–3.6V  $V_{CC}$  specifications provided
- 5.8 ns  $t_{PD}$  max ( $V_{CC} = 3.3V$ ), 10  $\mu A$   $I_{CC}$  max
- Power down high impedance inputs and outputs
- $\pm 24$  mA output drive ( $V_{CC} = 3.0V$ )
- Implements patented noise/EMI reduction circuitry
- Latch-up performance exceeds 500 mA
- ESD performance:
  - Human body model > 2000V
  - Machine model > 200V

### Ordering Code:

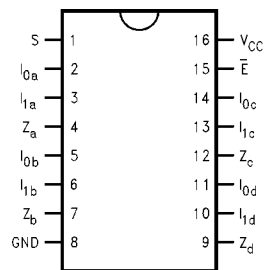
Order Number	Package Number	Package Description
74LCX157M	M16A	16-Lead Small Outline Integrated Circuit (SOIC), JEDEC MS-012, 0.150" Narrow
74LCX157SJ	M16D	16-Lead Small Outline Package (SOP), EIAJ TYPE II, 5.3mm Wide
74LCX157MTC	MTC16	16-Lead Thin Shrink Small Outline Package (TSSOP), JEDEC MO-153, 4.4mm Wide

Devices also available in Tape and Reel. Specify by appending the suffix letter "X" to the ordering code.

### Logic Symbols



### Connection Diagram



### Pin Descriptions

Pin Names	Description
$I_{0a}$ – $I_{0d}$	Source 0 Data Inputs
$I_{1a}$ – $I_{1d}$	Source 1 Data Inputs
$\bar{E}$	Enable Input
S	Select Input
$Z_a$ – $Z_d$	Outputs

## Functional Description

The LCX157 is a quad 2-input multiplexer. It selects four bits of data from two sources under the control of a common Select input (S). The Enable input ( $\bar{E}$ ) is active-LOW. When  $\bar{E}$  is HIGH, all of the outputs (Z) are forced LOW regardless of all other inputs. The LCX157 is the logic implementation of a 4-pole, 2-position switch where the position of the switch is determined by the logic levels supplied to the Select input. The logic equations for the outputs are shown below:

$$Z_a = \bar{E} \cdot (I_{1a} \cdot S + I_{0a} \cdot \bar{S})$$

$$Z_b = \bar{E} \cdot (I_{1b} \cdot S + I_{0b} \cdot \bar{S})$$

$$Z_c = \bar{E} \cdot (I_{1c} \cdot S + I_{0c} \cdot \bar{S})$$

$$Z_d = \bar{E} \cdot (I_{1d} \cdot S + I_{0d} \cdot \bar{S})$$

A common use of the LCX157 is the moving of data from two groups of registers to four common output busses. The particular register from which the data comes is determined by the state of the Select input. A less obvious use is as a function generator. The LCX157 can generate any four of

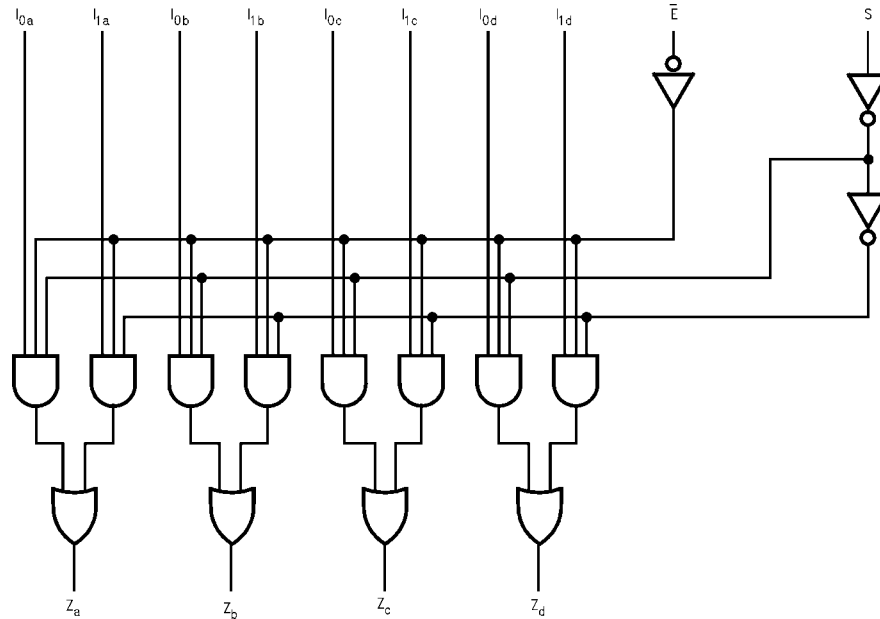
the sixteen different functions of two variables with one variable common. This is useful for implementing gating functions.

## Truth Table

Inputs				Outputs
$\bar{E}$	S	$I_0$	$I_1$	Z
H	X	X	X	L
L	H	X	L	L
L	H	X	H	H
L	L	L	X	L
L	L	H	X	H

H = HIGH Voltage Level  
L = LOW Voltage Level  
X = Immaterial

## Logic Diagram



Please note that this diagram is provided only for the understanding of logic operations and should not be used to estimate propagation delays.

Absolute Maximum Ratings (Note 1)					
Symbol	Parameter	Value	Conditions	Units	
$V_{CC}$	Supply Voltage	-0.5 to +7.0		V	
$V_I$	DC Input Voltage	-0.5 to +7.0		V	
$V_O$	DC Output Voltage	-0.5 to $V_{CC} + 0.5$	Output in HIGH or LOW State (Note 2)	V	
$I_{IK}$	DC Input Diode Current	-50	$V_I < GND$	mA	
$I_{OK}$	DC Output Diode Current	-50	$V_O < GND$	mA	
		+50	$V_O > V_{CC}$		
$I_O$	DC Output Source/Sink Current	$\pm 50$		mA	
$I_{CC}$	DC Supply Current per Supply Pin	$\pm 100$		mA	
$I_{GND}$	DC Ground Current per Ground Pin	$\pm 100$		mA	
$T_{STG}$	Storage Temperature	-65 to +150		°C	

Recommended Operating Conditions (Note 3)					
Symbol	Parameter	Min	Max	Units	
$V_{CC}$	Supply Voltage	Operating	2.0	3.6	V
		Data Retention	1.5	3.6	
$V_I$	Input Voltage	0	5.5	V	
$V_O$	Output Voltage	0	$V_{CC}$	V	
$I_{OH}/I_{OL}$	Output Current	$V_{CC} = 3.0V - 3.6V$		$\pm 24$	mA
		$V_{CC} = 2.7V - 3.0V$		$\pm 12$	
		$V_{CC} = 2.3V - 2.7V$		$\pm 8$	
$T_A$	Free-Air Operating Temperature	-40	85	°C	
$\Delta t/\Delta V$	Input Edge Rate, $V_{IN} = 0.8V - 2.0V$ , $V_{CC} = 3.0V$	0	10	ns/V	

**Note 1:** The Absolute Maximum Ratings are those values beyond which the safety of the device cannot be guaranteed. The device should not be operated at these limits. The parametric values defined in the Electrical Characteristics tables are not guaranteed at the Absolute Maximum Ratings. The "Recommended Operating Conditions" table will define the conditions for actual device operation.

**Note 2:**  $I_O$  Absolute Maximum Rating must be observed.

**Note 3:** Unused inputs must be held HIGH or LOW. They may not float.

### DC Electrical Characteristics

Symbol	Parameter	Conditions	$V_{CC}$ (V)	$T_A = -40^\circ\text{C to } +85^\circ\text{C}$		Units
				Min	Max	
$V_{IH}$	HIGH Level Input Voltage		2.3 - 2.7	1.7		V
			2.7 - 3.6	2.0		
$V_{IL}$	LOW Level Input Voltage		2.3 - 2.7		0.7	V
			2.7 - 3.6		0.8	
$V_{OH}$	HIGH Level Output Voltage	$I_{OH} = -100 \mu\text{A}$	2.3 - 3.6	$V_{CC} - 0.2$		V
		$I_{OH} = -8 \text{ mA}$	2.3	1.8		
		$I_{OH} = -12 \text{ mA}$	2.7	2.2		
		$I_{OH} = -18 \text{ mA}$	3.0	2.4		
		$I_{OH} = -24 \text{ mA}$	3.0	2.2		
$V_{OL}$	LOW Level Output Voltage	$I_{OL} = 100 \mu\text{A}$	2.3 - 3.6		0.2	V
		$I_{OH} = 8 \text{ mA}$	2.3		0.6	
		$I_{OL} = 12 \text{ mA}$	2.7		0.4	
		$I_{OL} = 16 \text{ mA}$	3.0		0.4	
		$I_{OL} = 24 \text{ mA}$	3.0		0.55	
$I_I$	Input Leakage Current	$0 \leq V_I \leq 5.5V$	2.3 - 3.6		$\pm 5.0$	$\mu\text{A}$
$I_{OFF}$	Power-Off Leakage Current	$V_I$ or $V_O = 5.5V$	0		10	$\mu\text{A}$
$I_{CC}$	Quiescent Supply Current	$V_I = V_{CC}$ or GND	2.3 - 3.6		10	$\mu\text{A}$
		$3.6V \leq V_I \leq 5.5V$	2.3 - 3.6		$\pm 10$	
$\Delta I_{CC}$	Increase in $I_{CC}$ per Input	$V_{IH} = V_{CC} - 0.6V$	2.3 - 3.6		500	$\mu\text{A}$

## AC Electrical Characteristics

Symbol	Parameter	$T_A = -40^\circ\text{C to } +85^\circ\text{C}, R_L = 500\Omega$						Units
		$V_{CC} = 3.3V \pm 0.3V$		$V_{CC} = 2.7V$		$V_{CC} = 2.5V \pm 0.2V$		
		$C_L = 50\text{ pF}$		$C_L = 50\text{ pF}$		$C_L = 30\text{ pF}$		
		Min	Max	Min	Max	Min	Max	
$t_{PHL}$	Propagation Delay	1.5	7.0	1.5	8.0	1.5	8.4	ns
$t_{PLH}$	$S \rightarrow Z_n$	1.5	7.0	1.5	8.0	1.5	8.4	
$t_{PHL}$	Propagation Delay	1.5	7.0	1.5	8.0	1.5	8.4	ns
$t_{PLH}$	$\bar{E} \rightarrow Z_n$	1.5	7.0	1.5	8.0	1.5	8.4	
$t_{PHL}$	Propagation Delay	1.5	5.8	1.5	6.3	1.5	7.0	ns
$t_{PLH}$	$I_n \rightarrow Z_n$	1.5	5.8	1.5	6.3	1.5	7.0	
$t_{OSHL}$	Output to Output Skew		1.0					ns
$t_{OSLH}$	(Note 4)		1.0					

**Note 4:** Skew is defined as the absolute value of the difference between the actual propagation delay for any two separate outputs of the same device. The specification applies to any outputs switching in the same direction, either HIGH-to-LOW ( $t_{OSHL}$ ) or LOW-to-HIGH ( $t_{OSLH}$ ). Parameter guaranteed by design.

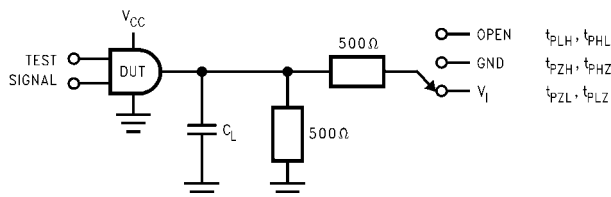
## Dynamic Switching Characteristics

Symbol	Parameter	Conditions	$V_{CC}$ (V)	$T_A = 25^\circ\text{C}$	Units
				Typical	
$V_{OLP}$	Quiet Output Dynamic Peak $V_{OL}$	$C_L = 50\text{ pF}, V_{IH} = 3.3V, V_{IL} = 0V$ $C_L = 30\text{ pF}, V_{IH} = 2.5V, V_{IL} = 0V$	3.3 2.5	0.8 0.6	V
$V_{OLV}$	Quiet Output Dynamic Valley $V_{OL}$	$C_L = 50\text{ pF}, V_{IH} = 3.3V, V_{IL} = 0V$ $C_L = 30\text{ pF}, V_{IH} = 2.5V, V_{IL} = 0V$	3.3 2.5	-0.8 -0.6	V

## Capacitance

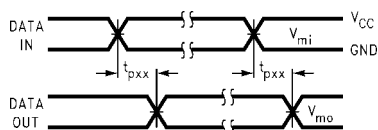
Symbol	Parameter	Conditions	Typical	Units
$C_{IN}$	Input Capacitance	$V_{CC} = \text{Open}, V_I = 0V \text{ or } V_{CC}$	7	pF
$C_{OUT}$	Output Capacitance	$V_{CC} = 3.3V, V_I = 0V \text{ or } V_{CC}$	8	pF
$C_{PD}$	Power Dissipation Capacitance	$V_{CC} = 3.3V, V_I = 0V \text{ or } V_{CC}, f = 10\text{ MHz}$	25	pF

**AC LOADING and WAVEFORMS** Generic for LCX Family

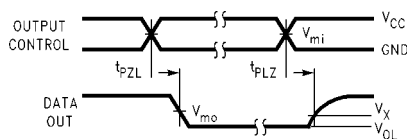


**FIGURE 1. AC Test Circuit ( $C_L$  includes probe and jig capacitance)**

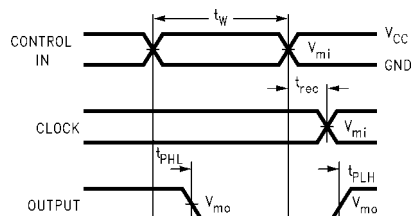
Test	Switch
$t_{PLH}$ , $t_{PHL}$	Open
$t_{PZL}$ , $t_{PLZ}$	6V at $V_{CC} = 3.3 \pm 0.3V$ $V_{CC} \times 2$ at $V_{CC} = 2.5 \pm 0.2V$
$t_{PZH}$ , $t_{PHZ}$	GND



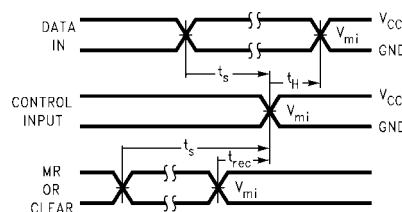
**Waveform for Inverting and Non-Inverting Functions**



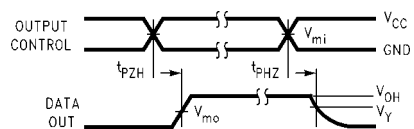
**3-STATE Output Low Enable and Disable Times for Logic**



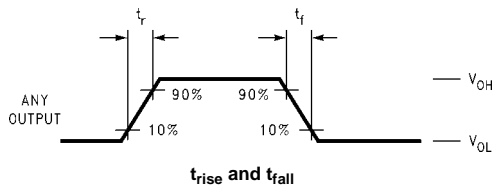
**Propagation Delay, Pulse Width and  $t_{rec}$  Waveforms**



**Setup Time, Hold Time and Recovery Time for Logic**



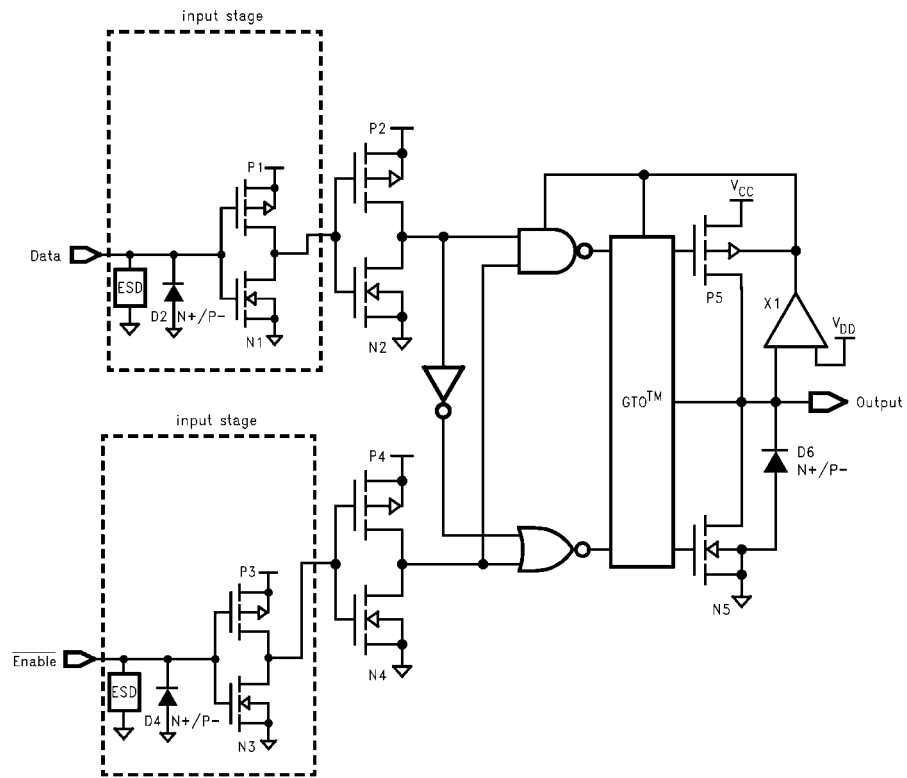
**3-STATE Output High Enable and Disable Times for Logic**



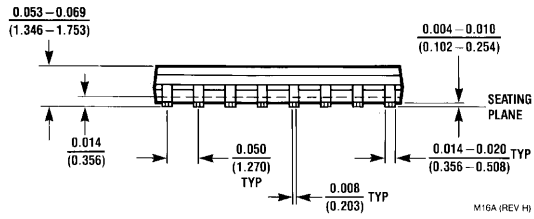
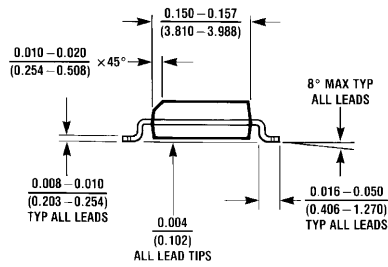
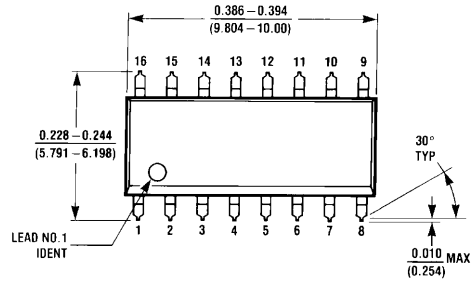
**FIGURE 2. Waveforms**  
(Input Characteristics;  $f = 1MHz$ ,  $t_r = t_f = 3ns$ )

Symbol	$V_{CC}$		
	$3.3V \pm 0.3V$	2.7V	$2.5V \pm 0.2V$
$V_{mi}$	1.5V	1.5V	$V_{CC}/2$
$V_{mo}$	1.5V	1.5V	$V_{CC}/2$
$V_x$	$V_{OL} + 0.3V$	$V_{OL} + 0.3V$	$V_{OL} + 0.15V$
$V_y$	$V_{OH} - 0.3V$	$V_{OH} - 0.3V$	$V_{OH} - 0.15V$

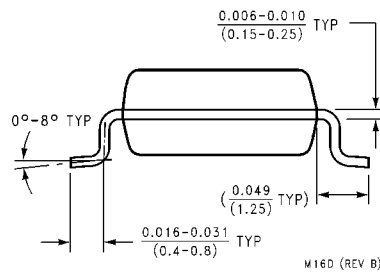
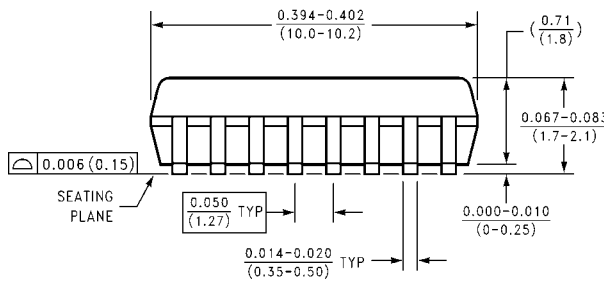
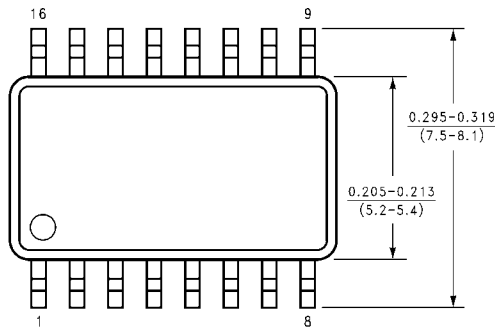
**Schematic Diagram** Generic for LCX Family



**Physical Dimensions** inches (millimeters) unless otherwise noted

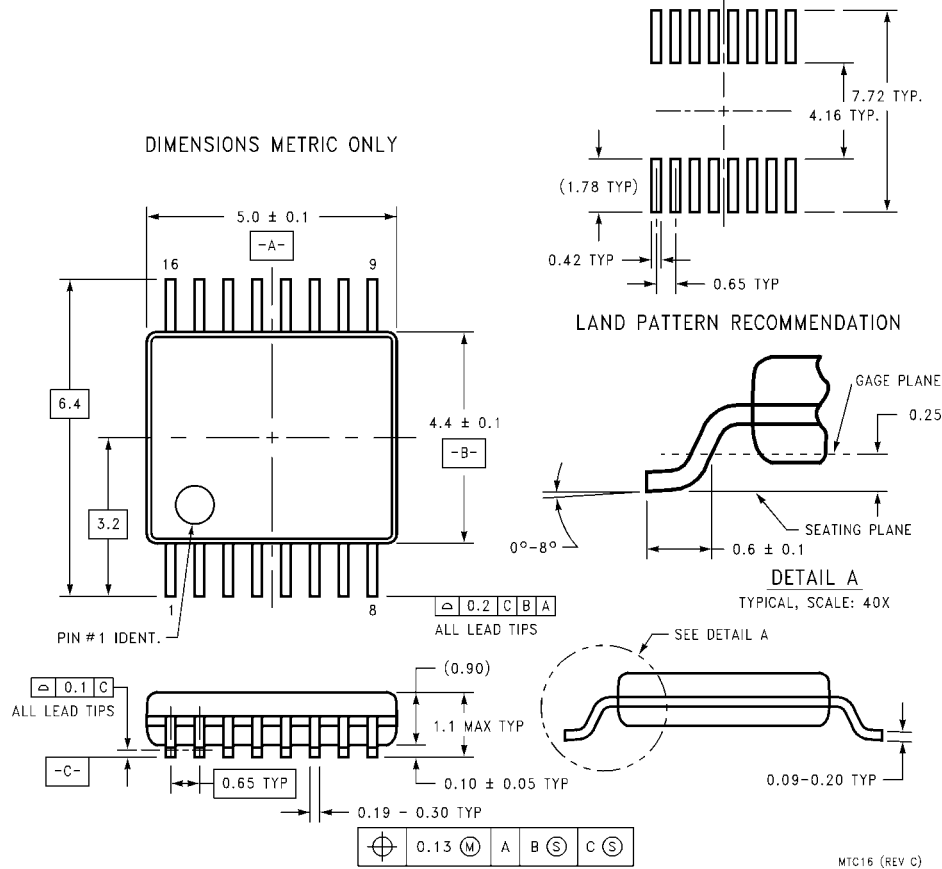


**16-Lead Small Outline Integrated Circuit (SOIC), JEDEC MS-012, 0.150" Narrow  
Package Number M16A**



**16-Lead Small Outline Package (SOP), EIAJ TYPE II, 5.3mm Wide  
Package Number M16D**

**Physical Dimensions** inches (millimeters) unless otherwise noted (Continued)



16-Lead Thin Shrink Small Outline Package (TSSOP), JEDEC MO-153, 4.4mm Wide  
Package Number MTC16

**LIFE SUPPORT POLICY**

FAIRCHILD'S PRODUCTS ARE NOT AUTHORIZED FOR USE AS CRITICAL COMPONENTS IN LIFE SUPPORT DEVICES OR SYSTEMS WITHOUT THE EXPRESS WRITTEN APPROVAL OF THE PRESIDENT OF FAIRCHILD SEMICONDUCTOR CORPORATION. As used herein:

1. Life support devices or systems are devices or systems which, (a) are intended for surgical implant into the body, or (b) support or sustain life, and (c) whose failure to perform when properly used in accordance with instructions for use provided in the labeling, can be reasonably expected to result in a significant injury to the user.
2. A critical component in any component of a life support device or system whose failure to perform can be reasonably expected to cause the failure of the life support device or system, or to affect its safety or effectiveness.

[www.fairchildsemi.com](http://www.fairchildsemi.com)