

# Schmitt-Trigger Positive-NAND Gates and Inverters with Totem-Pole Outputs

LS13 LS14

## FEATURES

- Operation from Very Slow Transitions
- Temperature-Compensated Threshold Levels
- Temperature-Compensated Hysteresis, Typically 0.8V
- High Noise Immunity

## DESCRIPTION

Each circuit functions as a NAND gate or inverter, but because of the Schmitt action, it has different input threshold levels for positive- and negative-going signals. The hysteresis or backlash, which is the difference between the two threshold levels, is typically 800 millivolts.

These circuits are temperature compensated and can be triggered from the slowest of input ramps and still give clean, jitter-free output signals.

## PIN-OUT AND LOGIC DIAGRAMS

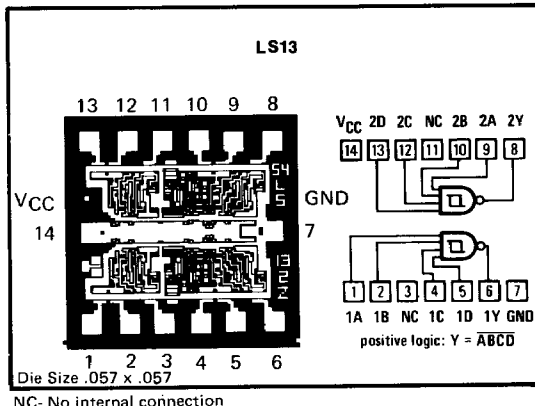

## SCHMATIC (EACH GATE)

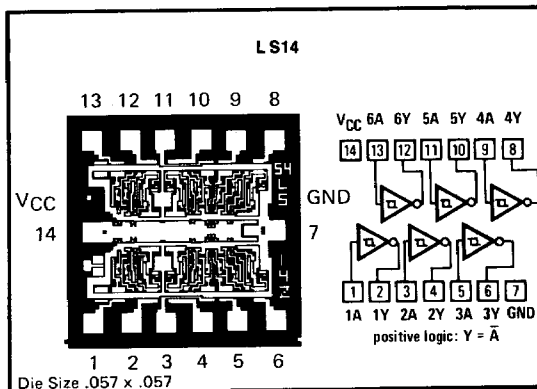
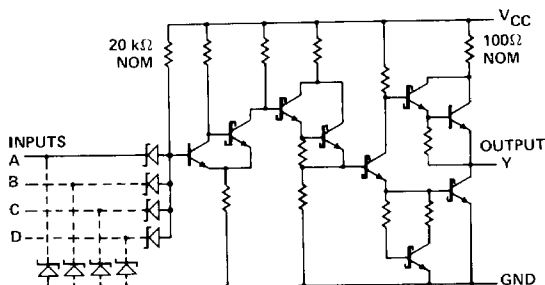

## Recommended Operating Conditions

	9LS/54LS			9LS/74LS			Unit
	Min	Nom	Max	Min	Nom	Max	
Supply voltage, $V_{CC}$	4.5	5	5.5	4.75	5	5.25	V
High-level output current, $I_{OH}$			-400			-400	$\mu A$
Low-level output current, $I_{OL}$			4			8	mA
Operating free-air temperature, $T_A$	-55		125	0		70	$^{\circ}C$

# Schmitt-Trigger Positive-NAND Gates and Inverters with Totem-Pole Outputs

LS13 LS14

## Electrical Characteristics Over Recommended Free-Air Temperature Range (Unless Otherwise Noted)

Parameter	Test Conditions*	9LS/54LS			9LS/74LS			Unit	
		Min	Typ**	Max	Min	Typ**	Max		
$V_{T+}$	$V_{CC}=5V$	1.4	1.6	1.9	1.4	1.6	1.9	V	
$V_{T-}$	$V_{CC}=5V$	.5	.8	1.0	.5	.8	1.0	V	
$V_{T+} - V_{T-}$	$V_{CC}=5V$	0.4	0.8		0.4	0.8		V	
$V_I$	$V_{CC}=\text{MIN}, I_I = -18\text{mA}$			-1.5			-1.5	V	
$V_{OH}$	$V_{CC}=\text{MIN}, I_{OH} = -400\mu\text{A}, V_I = 0.6V$	2.5	3.4		2.7	3.4		V	
$V_{OL}$	$V_{CC}=\text{MIN}, V_I = 2V$							V	
				$I_{OL} = 4\text{mA}$					
				$I_{OL} = 8\text{mA}$					
$I_{T+}$	$V_{CC}=5V, V_I = V_{T+}$						0.35	0.5	mA
$I_{T-}$	$V_{CC}=5V, V_I = V_{T-}$						-0.14		mA
$I_I$	$V_{CC}=\text{MAX}, V_I = 7V$						-0.18		mA
$I_{IH}$	$V_{CC}=\text{MAX}, V_I = 2.7V$						0.1		mA
$I_{IL}$	$V_{CC}=\text{MAX}, V_I = 0.4V$						20		$\mu\text{A}$
$I_{OS}$	$V_{CC}=\text{MAX}$						-0.4		mA
$I_{CCH}$	$V_{CC}=\text{MAX}, V_I = 0V$						-15		mA
							-100		mA
							2.9	6	mA
							8.6	16	mA
$I_{CCL}$	$V_{CC}=\text{MAX}, V_I = 4.5V$						4.1	7	mA
							12	21	mA
							4.1	7	mA
							12	21	mA

\*For conditions shown as MIN or MAX, use the appropriate value specified under recommended operating conditions for the applicable device type.

\*\*All typical values are at  $V_{CC} = 5V, T_A = 25^\circ\text{C}$ .

†Not more than one output should be shorted at a time.

## Switching Characteristics, $V_{CC} = 5V$ Over Recommended Free-Air Temperature Range

Parameter		$-55^\circ\text{C}$			$+25^\circ\text{C}$			$+125^\circ\text{C}$			Unit	
		Min	Typ	Max	Min	Typ	Max	Min	Typ	Max		
<b>Test Conditions: <math>C_L = 15\text{pF}, R_L = 2\text{k}\Omega</math> (See Fig. A, page 2-174)</b>												
$t_{PLH}$	LS13	16	28			15	22			16	30	ns
	LS14	16	28			15	22			16	30	ns
$t_{PHL}$	LS13	22	38			18	27			20	38	ns
	LS14	17	32			15	22			16	30	ns
<b>Test Conditions: <math>C_L = 50\text{pF}, R_L = 2\text{k}\Omega</math> (See Fig. A, page 2-174)</b>												
$t_{PLH}$	LS13	20	38			20	27			20	38	ns
	LS14	20	38			20	27			21	38	ns
$t_{PHL}$	LS13	25	42			25	33			25	42	ns
	LS14	21	38			20	27			21	38	ns

Note: AC specification shown under  $-55^\circ\text{C}$  and  $+125^\circ\text{C}$  are for 9LS devices only. All 50pF specifications are for 9LS only.

### PARAMETER MEASUREMENT INFORMATION

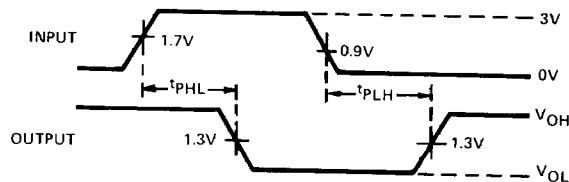

### VOLTAGE WAVEFORMS

- NOTES:
- The input waveform is supplied by a generator with the following characteristics:  
 $Z_{out} = 50\Omega$  and  $PRR \leq 1\text{ MHz}, t_r \leq 15\text{ ns}, t_f \leq 6\text{ ns}$ .
  - $C_L$  includes probe and jig capacitance.
  - All diodes are 1N916 or 1N3064.

## TYPICAL CHARACTERISTICS†

**POSITIVE-GOING THRESHOLD VOLTAGE VS FREE-AIR TEMPERATURE.**

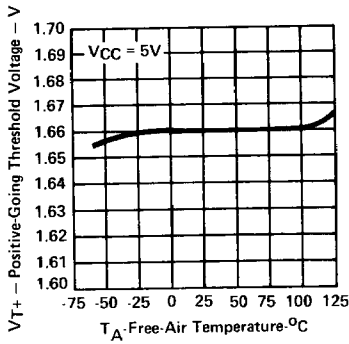

**NEGATIVE-GOING THRESHOLD VOLTAGE VS FREE-AIR TEMPERATURE.**

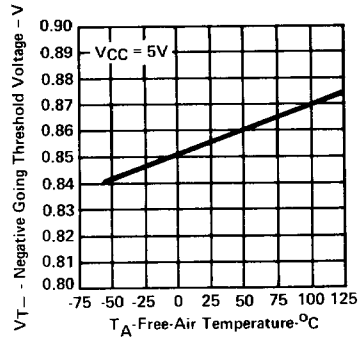

**HYSTERESIS VS FREE-AIR TEMPERATURE.**

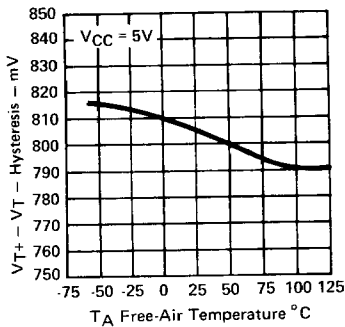

**DISTRIBUTION OF UNITS FOR HYSTERESIS.**

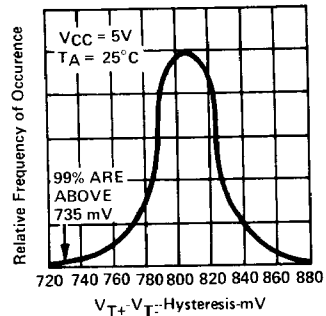

**THRESHOLD VOLTAGES AND HYSTERESIS VS SUPPLY VOLTAGE.**

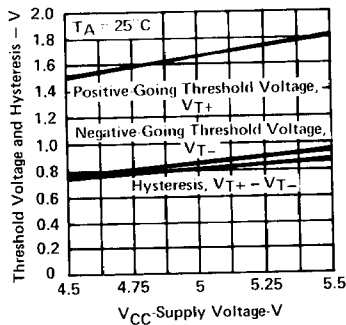

**OUTPUT VOLTAGE VS INPUT VOLTAGE.**

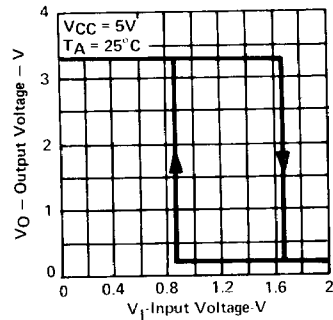

† Data for temperatures below 0°C and above 70°C and supply voltages below 4.75V and above 5.25 are applicable for 9LS/54LS13, and 9LS/54LS14.

# Schmitt-Trigger Positive-NAND Gates and Inverters with Totem-Pole Outputs

LS13 LS14

## TYPICAL APPLICATION DATA

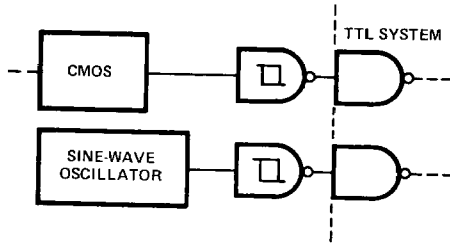

TTL SYSTEM INTERFACE FOR SLOW INPUT WAVEFORMS

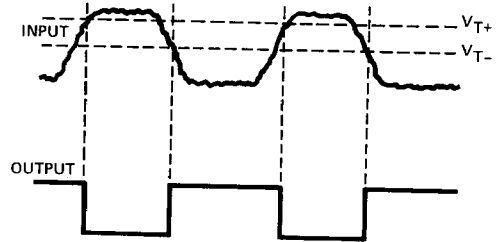

PULSE SHAPER

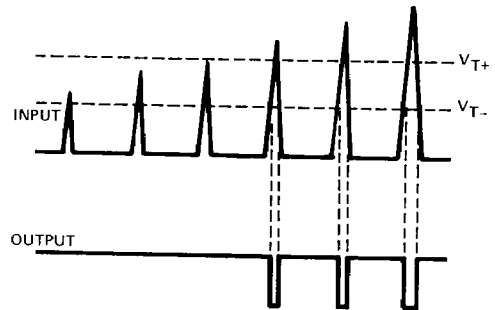
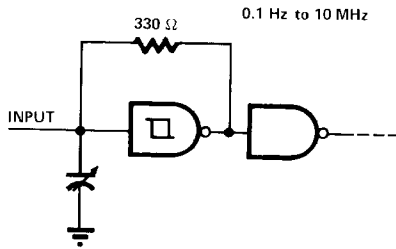

THRESHOLD DETECTOR

MULTIVIBRATOR

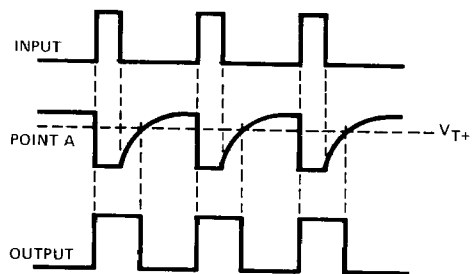
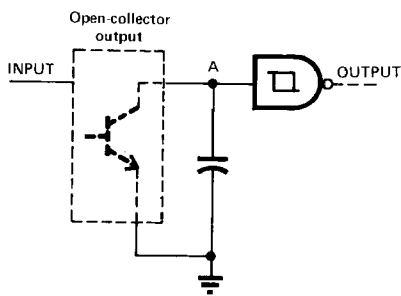

PULSE STRETCHER