



QUAD 2-INPUT MULTIPLEXER

The LSTTL/MSI SN54L/74LS158 is a high speed Quad 2-input Multiplexer. It selects four bits of data from two sources using the common Select and Enable inputs. The four buffered outputs present the selected data in the inverted form. The LS158 can also generate any four of the 16 different functions of two variables. The LS158 is fabricated with the Schottky barrier diode process for high speed and is completely compatible with all Motorola TTL families.

- Schottky Process for High Speed
- Multifunction Capability
- Inverted Outputs
- Input Clamp Diodes Limit High Speed Termination Effects
- ESD > 3500 Volts
- Special Circuitry Ensures Glitch Free Multiplexing

CONNECTION DIAGRAM DIP (TOP VIEW)

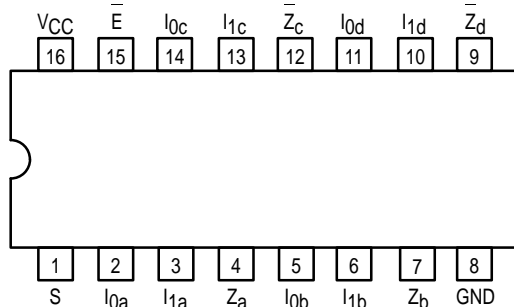

NOTE:
The Flatpak version has the same pinouts (Connection Diagram) as the Dual In-Line Package.

PIN NAMES

S	Common Select Input
E	Enable (Active LOW) Input
I0a-I0d	Data Inputs from Source 0
I1a-I1d	Data Inputs from Source 1
Za-Zd	Inverted Outputs (Note b)

LOADING (Note a)

	HIGH	LOW
S	1.0 U.L.	0.5 U.L.
E	1.0 U.L.	0.5 U.L.
I0a-I0d	0.5 U.L.	0.25 U.L.
I1a-I1d	0.5 U.L.	0.25 U.L.
Za-Zd	10 U.L.	5 (2.5) U.L.

NOTES:

- a) 1 TTL Unit Load (U.L.) = 40 μ A HIGH/1.6 mA LOW.
b) The Output LOW drive factor is 2.5 U.L. for Military (54) and 5 U.L. for Commercial (74) Temperature Ranges.

LOGIC DIAGRAM

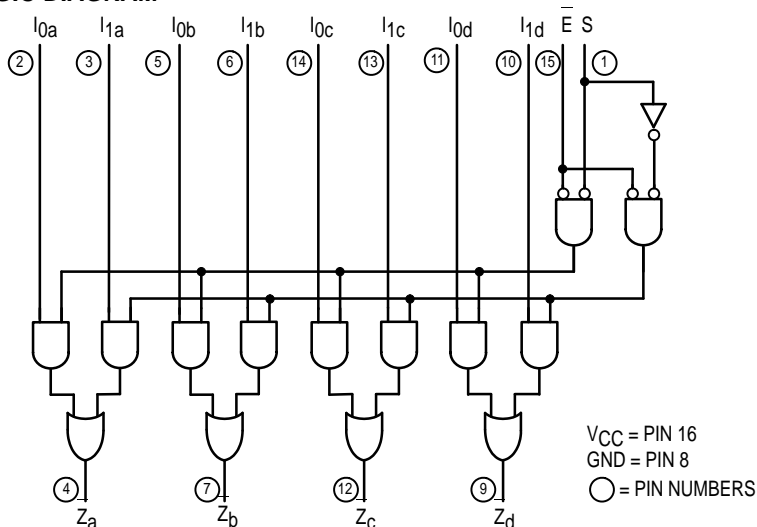

SN54/74LS158

QUAD 2-INPUT MULTIPLEXER LOW POWER SCHOTTKY

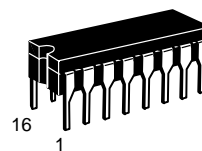

J SUFFIX
CERAMIC
CASE 620-09

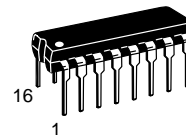

N SUFFIX
PLASTIC
CASE 648-08

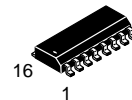

D SUFFIX
SOIC
CASE 751B-03

ORDERING INFORMATION

SN54LSXXXJ Ceramic
SN74LSXXXN Plastic
SN74LSXXXD SOIC

LOGIC SYMBOL

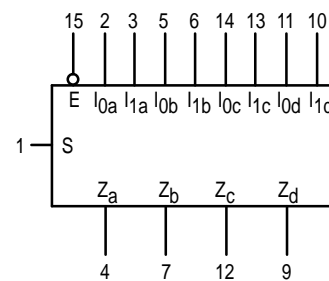

VCC = PIN 16
GND = PIN 8

SN54/74LS158

FUNCTIONAL DESCRIPTION

The LS158 is a Quad 2-input Multiplexer fabricated with the Schottky barrier diode process for high speed. It selects four bits of data from two sources under the control of a common Select Input (S) and presents the data in inverted form at the four outputs. The Enable Input (E) is active LOW. When E is HIGH, all of the outputs (Z) are forced HIGH regardless of all other inputs.

The LS158 is the logic implementation of a 4-pole, 2-position switch where the position of the switch is deter-

mined by the logic levels supplied to the Select Input.

A common use of the LS158 is the moving of data from two groups of registers to four common output busses. The particular register from which the data comes is determined by the state of the Select Input. A less obvious use is as a function generator. The LS158 can generate four functions of two variables with one variable common. This is useful for implementing gating functions.

TRUTH TABLE

ENABLE	SELECT INPUT	INPUTS		OUTPUT
E	S	I ₀	I ₁	Z
H	X	X	X	H
L	L	L	X	H
L	L	H	X	L
L	H	X	L	H
L	H	X	H	L

H = HIGH Voltage Level
 L = LOW Voltage Level
 X = Don't Care

GUARANTEED OPERATING RANGES

Symbol	Parameter		Min	Typ	Max	Unit
V _{CC}	Supply Voltage	54 74	4.5 4.75	5.0 5.0	5.5 5.25	V
T _A	Operating Ambient Temperature Range	54 74	-55 0	25 25	125 70	°C
I _{OH}	Output Current — High	54, 74			-0.4	mA
I _{OL}	Output Current — Low	54 74			4.0 8.0	mA

SN54/74LS158

DC CHARACTERISTICS OVER OPERATING TEMPERATURE RANGE (unless otherwise specified)

Symbol	Parameter	Limits			Unit	Test Conditions
		Min	Typ	Max		
V _{IH}	Input HIGH Voltage	2.0			V	Guaranteed Input HIGH Voltage for All Inputs
V _{IL}	Input LOW Voltage	54		0.7	V	Guaranteed Input LOW Voltage for All Inputs
		74		0.8		
V _{IK}	Input Clamp Diode Voltage		-0.65	-1.5	V	V _{CC} = MIN, I _{IN} = -18 mA
V _{OH}	Output HIGH Voltage	54	2.5	3.5	V	V _{CC} = MIN, I _{OH} = MAX, V _{IN} = V _{IH} or V _{IL} per Truth Table
		74	2.7	3.5	V	
V _{OL}	Output LOW Voltage	54, 74	0.25	0.4	V	I _{OL} = 4.0 mA
		74	0.35	0.5	V	I _{OL} = 8.0 mA
I _{IH}	Input HIGH Current I _Q , I ₁ E, S			20 40	μA	V _{CC} = MAX, V _{IN} = 2.7 V
	I _Q , I ₁ E, S			0.1 0.2	mA	V _{CC} = MAX, V _{IN} = 7.0 V
I _{IL}	Input LOW Current I _Q , I ₁ E, S			-0.4 -0.8	mA	V _{CC} = MAX, V _{IN} = 0.4 V
I _{OS}	Short Circuit Current (Note 1)	-20		-100	mA	V _{CC} = MAX
I _{CC}	Power Supply Current			8.0	mA	V _{CC} = MAX All inputs at 4.5 V. All outputs open.
I _{CC}	Power Supply Current			11	mA	V _{CC} = MAX All other input combinations. All outputs open.

Note 1: Not more than one output should be shorted at a time, nor for more than 1 second.

AC CHARACTERISTICS (T_A = 25°C)

Symbol	Parameter	Limits			Unit	Test Conditions
		Min	Typ	Max		
t _{PLH} t _{PHL}	Propagation Delay Data to Output		7.0 10	12 15	ns	V _{CC} = 5.0 V C _L = 15 pF
t _{PLH} t _{PHL}	Propagation Delay Enable to Output		11 18	17 24	ns	
t _{PLH} t _{PHL}	Propagation Delay Select to Output		13 16	20 24	ns	

AC WAVEFORMS

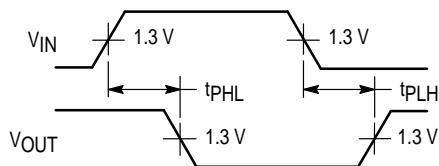

Figure 1

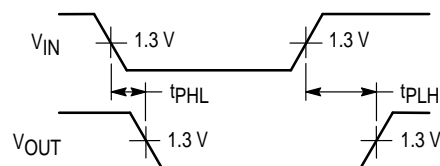

Figure 2