

# SN74LS47

## BCD to 7-Segment Decoder/Driver

The SN74LS47 are Low Power Schottky BCD to 7-Segment Decoder/Drivers consisting of NAND gates, input buffers and seven AND-OR-INVERT gates. They offer active LOW, high sink current outputs for driving indicators directly. Seven NAND gates and one driver are connected in pairs to make BCD data and its complement available to the seven decoding AND-OR-INVERT gates. The remaining NAND gate and three input buffers provide lamp test, blanking input/ripple-blanking output and ripple-blanking input.

The circuits accept 4-bit binary-coded-decimal (BCD) and, depending on the state of the auxiliary inputs, decodes this data to drive a 7-segment display indicator. The relative positive-logic output levels, as well as conditions required at the auxiliary inputs, are shown in the truth tables. Output configurations of the SN74LS47 are designed to withstand the relatively high voltages required for 7-segment indicators.

These outputs will withstand 15 V with a maximum reverse current of 250  $\mu$ A. Indicator segments requiring up to 24 mA of current may be driven directly from the SN74LS47 high performance output transistors. Display patterns for BCD input counts above nine are unique symbols to authenticate input conditions.

The SN74LS47 incorporates automatic leading and/or trailing-edge zero-blanking control (RBI and RBO). Lamp test (LT) may be performed at any time which the BI/RBO node is a HIGH level. This device also contains an overriding blanking input (BI) which can be used to control the lamp intensity by varying the frequency and duty cycle of the BI input signal or to inhibit the outputs.

- Lamp Intensity Modulation Capability (BI/RBO)
- Open Collector Outputs
- Lamp Test Provision
- Leading/Trailing Zero Suppression
- Input Clamp Diodes Limit High-Speed Termination Effects

### GUARANTEED OPERATING RANGES

Symbol	Parameter	Min	Typ	Max	Unit
V <sub>CC</sub>	Supply Voltage	4.75	5.0	5.25	V
T <sub>A</sub>	Operating Ambient Temperature Range	0	25	70	°C
I <sub>OH</sub>	Output Current – High BI/RBO			-50	$\mu$ A
I <sub>OL</sub>	Output Current – Low BI/RBO BI/RBO			3.2	mA
V <sub>O(off)</sub>	Off-State Output Voltage a to g			15	V
I <sub>O(on)</sub>	On-State Output Current a to g			24	mA



**ON Semiconductor**

Formerly a Division of Motorola

<http://onsemi.com>

**LOW  
POWER  
SCHOTTKY**

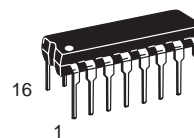

**PLASTIC  
N SUFFIX  
CASE 648**

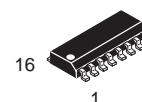

**SOIC  
D SUFFIX  
CASE 751B**

### ORDERING INFORMATION

Device	Package	Shipping
SN74LS47N	16 Pin DIP	2000 Units/Box
SN74LS47D	16 Pin	2500/Tape & Reel

# SN74LS47

## CONNECTION DIAGRAM DIP (TOP VIEW)

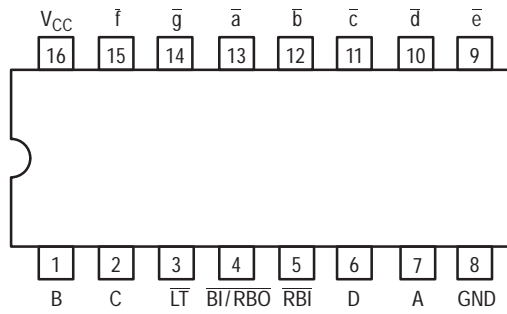

### PIN NAMES

A, B, C, D	BCD Inputs
$\overline{RBI}$	Ripple-Blanking Input
$\overline{LT}$	Lamp-Test Input
$\overline{BI/RBO}$	Blanking Input or Ripple-Blanking Output
$\overline{a}$ , to $\overline{g}$	Outputs

### LOADING (Note a)

	HIGH	LOW
A, B, C, D	0.5 U.L.	0.25 U.L.
$\overline{RBI}$	0.5 U.L.	0.25 U.L.
$\overline{LT}$	0.5 U.L.	0.25 U.L.
$\overline{BI/RBO}$	0.5 U.L.	0.75 U.L.
	1.2 U.L.	2.0 U.L.
$\overline{a}$ , to $\overline{g}$	Open-Collector	15 U.L.

### NOTES:

- 1 Unit Load (U.L.) = 40  $\mu$ A HIGH, 1.6 mA LOW.
- Output current measured at  $V_{OUT} = 0.5$  V  
The Output LOW drive factor is 15 U.L. for Commercial (74) Temperature Ranges.

### LOGIC SYMBOL

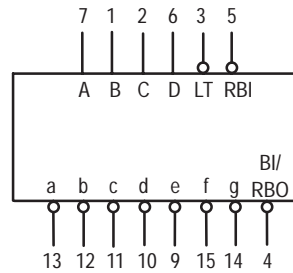

$V_{CC}$  = PIN 16  
GND = PIN 8

# SN74LS47

## LOGIC DIAGRAM

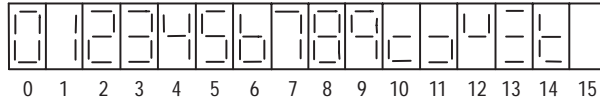
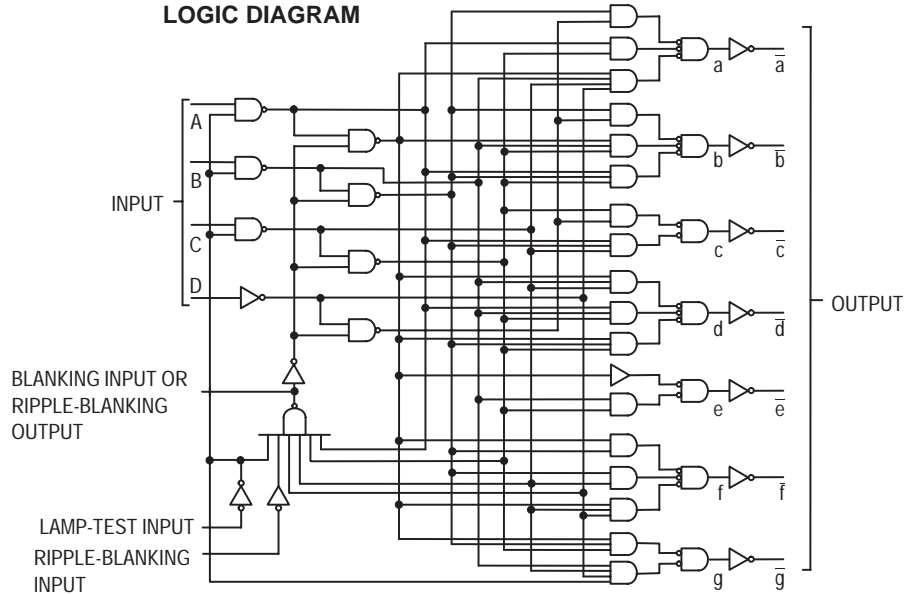

## NUMERICAL DESIGNATIONS — RESULTANT DISPLAYS

## TRUTH TABLE

DECIMAL OR FUNCTION	INPUTS							OUTPUTS							NOTE
	LT	RBI	D	C	B	A	BI/RBO	$\bar{a}$	$\bar{b}$	$\bar{c}$	$\bar{d}$	$\bar{e}$	$\bar{f}$	$\bar{g}$	
0	H	H	L	L	L	L	H	L	L	L	L	L	L	H	A
1	H	X	L	L	L	H	H	H	L	L	H	H	H	H	A
2	H	X	L	L	H	L	H	L	L	H	L	L	H	L	
3	H	X	L	L	H	H	H	L	L	L	L	H	H	L	
4	H	X	L	H	L	L	H	H	L	L	H	H	L	L	
5	H	X	L	H	L	H	H	L	H	L	L	H	L	L	
6	H	X	L	H	H	L	H	H	H	L	L	L	L	L	
7	H	X	L	H	H	H	H	L	L	L	H	H	H	H	
8	H	X	H	L	L	L	H	L	L	L	L	L	L	L	
9	H	X	H	L	L	H	H	L	L	L	H	H	L	L	
10	H	X	H	L	H	L	H	H	H	H	L	L	H	L	
11	H	X	H	L	H	H	H	H	H	L	L	H	H	L	
12	H	X	H	H	L	L	H	H	L	H	H	H	L	L	
13	H	X	H	H	L	H	H	L	H	H	L	H	L	L	
14	H	X	H	H	H	L	H	H	H	H	L	L	L	L	
15	H	X	H	H	H	H	H	H	H	H	H	H	H	H	
$\bar{BI}$	X	X	X	X	X	X	L	H	H	H	H	H	H	H	B
RBI	H	L	L	L	L	L	L	H	H	H	H	H	H	H	C
LT	L	X	X	X	X	X	H	L	L	L	L	L	L	L	D

H = HIGH Voltage Level  
L = LOW Voltage Level  
X = Immaterial

### NOTES:

- (A) BI/RBO is wire-AND logic serving as blanking Input (BI) and/or ripple-blanking output ( $\bar{RBO}$ ). The blanking out (BI) must be open or held at a HIGH level when output functions 0 through 15 are desired, and ripple-blanking input (RBI) must be open or at a HIGH level if blanking of a decimal 0 is not desired. X = input may be HIGH or LOW.
- (B) When a LOW level is applied to the blanking input (forced condition) all segment outputs go to a LOW level regardless of the state of any other input condition.
- (C) When ripple-blanking input (RBI) and inputs A, B, C, and D are at LOW level, with the lamp test input at HIGH level, all segment outputs go to a HIGH level and the ripple-blanking output (RBO) goes to a LOW level (response condition).
- (D) When the blanking input/ripple-blanking output (BI/RBO) is open or held at a HIGH level, and a LOW level is applied to lamp test input, all segment outputs go to a LOW level.

# SN74LS47

## DC CHARACTERISTICS OVER OPERATING TEMPERATURE RANGE (unless otherwise specified)

Symbol	Parameter	Limits			Unit	Test Conditions
		Min	Typ	Max		
$V_{IH}$	Input HIGH Voltage	2.0			V	Guaranteed Input HIGH Theshold Voltage for All Inputs
$V_{IL}$	Input LOW Voltage			0.8	V	Guaranteed Input LOW Threshold Voltage for All Inputs
$V_{IK}$	Input Clamp Diode Voltage		-0.65	-1.5	V	$V_{CC} = \text{MIN}$ , $I_{IN} = -18 \text{ mA}$
$V_{OH}$	Output HIGH Voltage, $\overline{BI}/\overline{R\overline{B}\overline{O}}$	2.4	4.2		V	$V_{CC} = \text{MIN}$ , $I_{OH} = -50 \mu\text{A}$ , $V_{IN} = V_{IN}$ or $V_{IL}$ per Truth Table
$V_{OL}$	Output LOW Voltage $\overline{BI}/\overline{R\overline{B}\overline{O}}$		0.25	0.4	V	$I_{OL} = 1.6 \text{ mA}$
			0.35	0.5	V	$I_{OL} = 3.2 \text{ mA}$
$I_{O(\text{off})}$	Off-State Output Current $\overline{a}$ thru $\overline{g}$			250	$\mu\text{A}$	$V_{CC} = \text{MAX}$ , $V_{IN} = V_{IN}$ or $V_{IL}$ per Truth Table, $V_{O(\text{off})} = 15 \text{ V}$
$V_{O(\text{on})}$	On-State Output Voltage $\overline{a}$ thru $\overline{g}$		0.25	0.4	V	$I_{O(\text{on})} = 12 \text{ mA}$
			0.35	0.5	V	$I_{O(\text{on})} = 24 \text{ mA}$
$I_{IH}$	Input HIGH Current			20	$\mu\text{A}$	$V_{CC} = \text{MAX}$ , $V_{IN} = 2.7 \text{ V}$
				0.1	mA	$V_{CC} = \text{MAX}$ , $V_{IN} = 7.0 \text{ V}$
$I_{IL}$	Input LOW Current $\overline{BI}/\overline{R\overline{B}\overline{O}}$ Any Input except $\overline{BI}/\overline{R\overline{B}\overline{O}}$			-1.2 -0.4	mA	$V_{CC} = \text{MAX}$ , $V_{IN} = 0.4 \text{ V}$
$I_{OS}$ $\overline{BI}/\overline{R\overline{B}\overline{O}}$	Output Short Circuit Current (Note 1)	-0.3		-2.0	mA	$V_{CC} = \text{MAX}$ , $V_{OUT} = 0 \text{ V}$
$I_{CC}$	Power Supply Current		7.0	13	mA	$V_{CC} = \text{MAX}$

Note 1: Not more than one output should be shorted at a time, nor for more than 1 second.

## AC CHARACTERISTICS ( $T_A = 25^\circ\text{C}$ )

Symbol	Parameter	Limits			Unit	Test Conditions
		Min	Typ	Max		
$t_{PHL}$ $t_{PLH}$	Propagation Delay, Address Input to Segment Output			100	ns	$V_{CC} = 5.0 \text{ V}$ $C_L = 15 \text{ pF}$
$t_{PHL}$ $t_{PLH}$	Propagation Delay, $\overline{RB\overline{I}}$ Input To Segment Output			100	ns	
				100	ns	

## AC WAVEFORMS

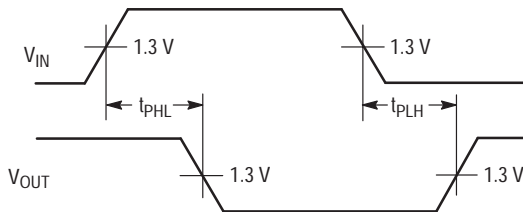

Figure 1.

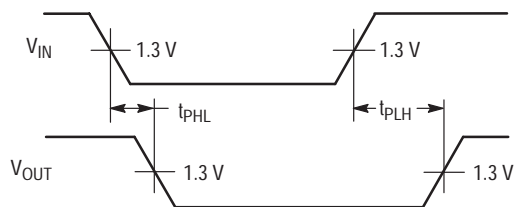

Figure 2.

# SN74LS47

## PACKAGE DIMENSIONS

**N SUFFIX**  
**PLASTIC PACKAGE**  
**CASE 648-08**  
**ISSUE R**



**NOTES:**

1. DIMENSIONING AND TOLERANCING PER ANSI Y14.5M, 1982.
2. CONTROLLING DIMENSION: INCH.
3. DIMENSION L TO CENTER OF LEADS WHEN FORMED PARALLEL.
4. DIMENSION B DOES NOT INCLUDE MOLD FLASH.
5. ROUNDED CORNERS OPTIONAL.

DIM	INCHES		MILLIMETERS	
	MIN	MAX	MIN	MAX
A	0.740	0.770	18.80	19.55
B	0.250	0.270	6.35	6.85
C	0.145	0.175	3.69	4.44
D	0.015	0.021	0.39	0.53
F	0.040	0.70	1.02	1.77
G	0.100 BSC		2.54 BSC	
H	0.050 BSC		1.27 BSC	
J	0.008	0.015	0.21	0.38
K	0.110	0.130	2.80	3.30
L	0.295	0.305	7.50	7.74
M	0° 10°		0° 10°	
S	0.020	0.040	0.51	1.01

# SN74LS47

## PACKAGE DIMENSIONS

### D SUFFIX PLASTIC SOIC PACKAGE CASE 751B-05 ISSUE J



#### NOTES:

1. DIMENSIONING AND TOLERANCING PER ANSI Y14.5M, 1982.
2. CONTROLLING DIMENSION: MILLIMETER.
3. DIMENSIONS A AND B DO NOT INCLUDE MOLD PROTRUSION.
4. MAXIMUM MOLD PROTRUSION 0.15 (0.006) PER SIDE.
5. DIMENSION D DOES NOT INCLUDE DAMBAR PROTRUSION. ALLOWABLE DAMBAR PROTRUSION SHALL BE 0.127 (0.005) TOTAL IN EXCESS OF THE D DIMENSION AT MAXIMUM MATERIAL CONDITION.

DIM	MILLIMETERS		INCHES	
	MIN	MAX	MIN	MAX
A	9.80	10.00	0.386	0.393
B	3.80	4.00	0.150	0.157
C	1.35	1.75	0.054	0.068
D	0.35	0.49	0.014	0.019
F	0.40	1.25	0.016	0.049
G	1.27 BSC		0.050 BSC	
J	0.19	0.25	0.008	0.009
K	0.10	0.25	0.004	0.009
M	0° 7°		0° 7°	
P	5.80	6.20	0.229	0.244
R	0.25	0.50	0.010	0.019

**Notes**

**ON Semiconductor** and  are trademarks of Semiconductor Components Industries, LLC (SCILLC). SCILLC reserves the right to make changes without further notice to any products herein. SCILLC makes no warranty, representation or guarantee regarding the suitability of its products for any particular purpose, nor does SCILLC assume any liability arising out of the application or use of any product or circuit, and specifically disclaims any and all liability, including without limitation special, consequential or incidental damages. "Typical" parameters which may be provided in SCILLC data sheets and/or specifications can and do vary in different applications and actual performance may vary over time. All operating parameters, including "Typicals" must be validated for each customer application by customer's technical experts. SCILLC does not convey any license under its patent rights nor the rights of others. SCILLC products are not designed, intended, or authorized for use as components in systems intended for surgical implant into the body, or other applications intended to support or sustain life, or for any other application in which the failure of the SCILLC product could create a situation where personal injury or death may occur. Should Buyer purchase or use SCILLC products for any such unintended or unauthorized application, Buyer shall indemnify and hold SCILLC and its officers, employees, subsidiaries, affiliates, and distributors harmless against all claims, costs, damages, and expenses, and reasonable attorney fees arising out of, directly or indirectly, any claim of personal injury or death associated with such unintended or unauthorized use, even if such claim alleges that SCILLC was negligent regarding the design or manufacture of the part. SCILLC is an Equal Opportunity/Affirmative Action Employer.

## PUBLICATION ORDERING INFORMATION

### North America Literature Fulfillment:

Literature Distribution Center for ON Semiconductor  
P.O. Box 5163, Denver, Colorado 80217 USA  
**Phone:** 303-675-2175 or 800-344-3860 Toll Free USA/Canada  
**Fax:** 303-675-2176 or 800-344-3867 Toll Free USA/Canada  
**Email:** ONlit@hibbertco.com

**N. American Technical Support:** 800-282-9855 Toll Free USA/Canada

**EUROPE:** LDC for ON Semiconductor – European Support

**German Phone:** (+1) 303-308-7140 (M-F 2:30pm to 5:00pm Munich Time)  
**Email:** ONlit-german@hibbertco.com  
**French Phone:** (+1) 303-308-7141 (M-F 2:30pm to 5:00pm Toulouse Time)  
**Email:** ONlit-french@hibbertco.com  
**English Phone:** (+1) 303-308-7142 (M-F 1:30pm to 5:00pm UK Time)  
**Email:** ONlit@hibbertco.com

**ASIA/PACIFIC:** LDC for ON Semiconductor – Asia Support

**Phone:** 303-675-2121 (Tue-Fri 9:00am to 1:00pm, Hong Kong Time)  
Toll Free from Hong Kong 800-4422-3781  
**Email:** ONlit-asia@hibbertco.com

**JAPAN:** ON Semiconductor, Japan Customer Focus Center  
4-32-1 Nishi-Gotanda, Shinagawa-ku, Tokyo, Japan 141-8549

**Phone:** 81-3-5487-8345  
**Email:** r14153@onsemi.com

**Fax Response Line:** 303-675-2167  
800-344-3810 Toll Free USA/Canada

**ON Semiconductor Website:** <http://onsemi.com>

For additional information, please contact your local  
Sales Representative.