

1. General description

The 74LVC1G99 provides a low voltage, ultra-configurable, multiple function gate with 3-state output. The device can be configured as one of several logic functions including, AND, OR, NAND, NOR, XOR, XNOR, inverter, buffer and MUX. No external components are required to configure the device as all inputs can be connected directly to V_{CC} or \overline{GND} . The 3-state output is controlled by the output enable input (\overline{OE}). A HIGH level at \overline{OE} causes the output (Y) to assume a high-impedance OFF-state. When \overline{OE} is LOW, the output state is determined by the signals applied to the Schmitt-trigger inputs (A, B, C and D).

Due to the use of Schmitt-trigger inputs the device is tolerant of slowly changing input signals, transforming them into sharply defined, jitter free output signals. By eliminating leakage current paths to V_{CC} and GND, the inputs and disabled output are also over-voltage tolerant, making the device suitable for mixed-voltage applications.

This device is fully specified for partial power-down applications using I_{OFF} . The I_{OFF} circuitry disables the output, preventing the damaging backflow current through the device when it is powered down.

The 74LVC1G99 is fully specified over the supply range from 1.65 V to 5.5 V.

2. Features and benefits

- Wide supply voltage range from 1.65 V to 5.5 V
- 5 V tolerant inputs for interfacing with 5 V logic
- High noise immunity
- Complies with JEDEC standard:
 - ◆ JESD8-7 (1.65 V to 1.95 V)
 - ◆ JESD8-5 (2.3 V to 2.7 V)
 - ◆ JESD8-B/JESD36 (2.7 V to 3.6 V)
- ESD protection:
 - ◆ HBM JESD22-A114F exceeds 2000 V
 - ◆ MM JESD22-A115-A exceeds 200 V
- ± 24 mA output drive ($V_{CC} = 3.0$ V)
- CMOS low power consumption
- Latch-up performance exceeds 250 mA
- Direct interface with TTL levels
- Inputs accept voltages up to 5 V
- Multiple package options
- Specified from -40 °C to $+85$ °C and -40 °C to $+125$ °C.

3. Ordering information

Table 1. Ordering information

Type number	Package			Version
	Temperature range	Name	Description	
74LVC1G99DP	-40 °C to +125 °C	TSSOP8	plastic thin shrink small outline package; 8 leads; body width 3 mm; lead length 0.5 mm	SOT505-2
74LVC1G99GT	-40 °C to +125 °C	XSON8	plastic extremely thin small outline package; no leads; 8 terminals; body 1 × 1.95 × 0.5 mm	SOT833-1
74LVC1G99GF	-40 °C to +125 °C	XSON8	extremely thin small outline package; no leads; 8 terminals; body 1.35 × 1 × 0.5 mm	SOT1089
74LVC1G99GD	-40 °C to +125 °C	XSON8U	plastic extremely thin small outline package; no leads; 8 terminals; UTLF based; body 3 × 2 × 0.5 mm	SOT996-2
74LVC1G99GM	-40 °C to +125 °C	XQFN8U	plastic extremely thin quad flat package; no leads; 8 terminals; UTLF based; body 1.6 × 1.6 × 0.5 mm	SOT902-1

4. Marking

Table 2. Marking codes [\[1\]](#)

Type number	Marking code
74LVC1G99DP	V99
74LVC1G99GT	V99
74LVC1G99GF	YF
74LVC1G99GD	V99
74LVC1G99GM	V99

[1] The pin 1 indicator is located on the lower left corner of the device, below the marking code.

5. Functional diagram

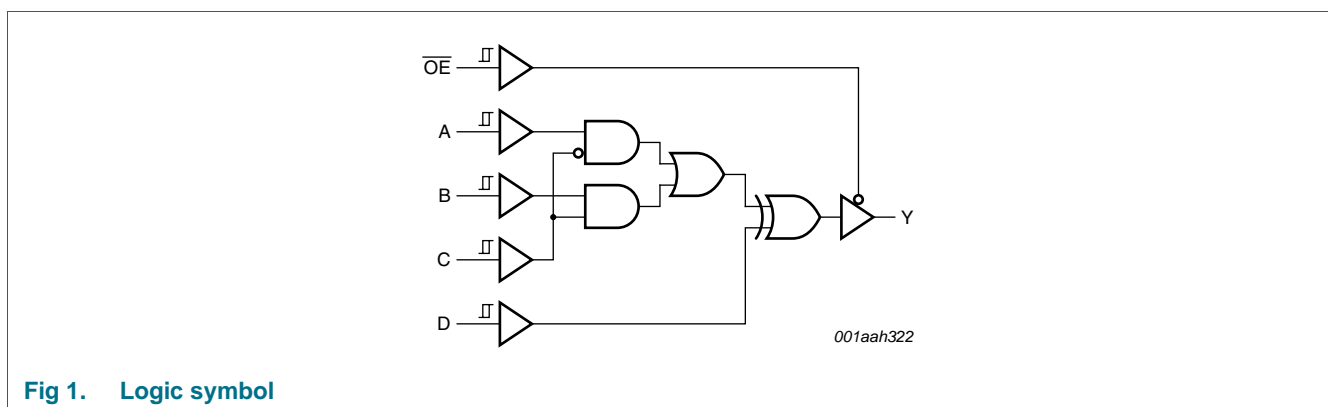

Fig 1. Logic symbol

6. Pinning information

6.1 Pinning

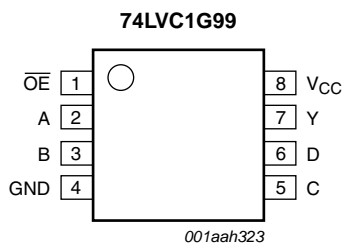

Fig 2. Pin configuration SOT505-2 (TSSOP8)

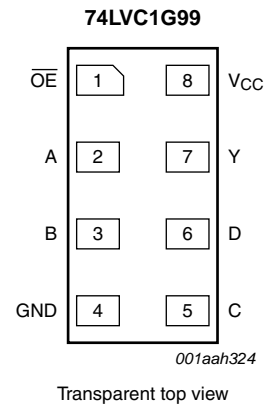

Fig 3. Pin configuration SOT833-1 and SOT1089 (XSON8)

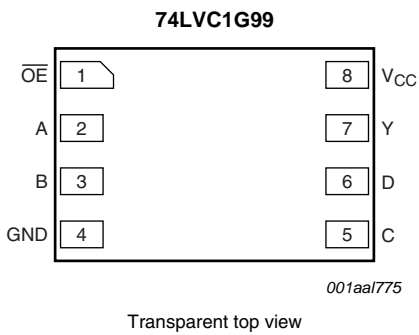

Fig 4. Pin configuration SOT996-2 (XSON8U)

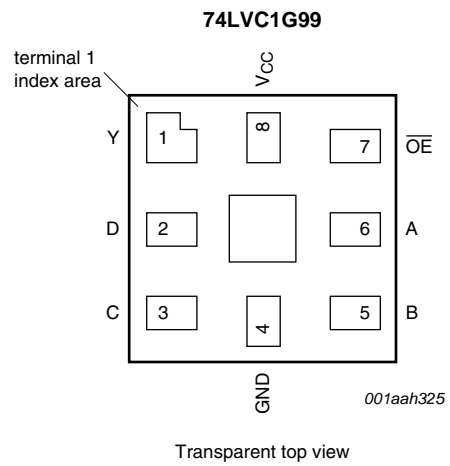

Fig 5. Pin configuration SOT902-1 (XQFN8U)

6.2 Pin description

Table 3. Pin description

Symbol	Pin		Description
	SOT505-2, SOT833-1, SOT996-2 and SOT1089	SOT902-1	
\overline{OE}	1	7	output enable input \overline{OE} (active LOW)
A	2	6	data input
B	3	5	data input
GND	4	4	ground (0 V)
C	5	3	data input
D	6	2	data input
Y	7	1	data output
V _{CC}	8	8	supply voltage

7. Functional description

Table 4. Function table^[1]

Input					Output
\overline{OE}	D	C	B	A	Y
L	L	L	L	L	L
L	L	L	L	H	H
L	L	L	H	L	L
L	L	L	H	H	H
L	L	H	L	L	L
L	L	H	L	H	L
L	L	H	H	L	H
L	L	H	H	H	H
L	H	L	L	L	H
L	H	L	L	H	L
L	H	L	H	L	H
L	H	L	H	H	L
L	H	H	L	L	H
L	H	H	L	H	H
L	H	H	H	L	L
L	H	H	H	H	L
H	X	X	X	X	Z

[1] H = HIGH voltage level;
 L = LOW voltage level;
 X = don't care;
 Z = high-impedance OFF-state.

7.1 Logic configurations

Table 5. Function selection table

Primary function	Complementary function
3-state buffer	
3-state inverter	
3-state 2-input multiplexer	
3-state 2-input multiplexer with inverting output	
3-state 2-input AND	3-state 2-input NOR with two inverting inputs
3-state 2-input AND with one inverting input	3-state 2-input NOR with one inverting input
3-state 2-input AND with two inverting inputs	3-state 2-input NOR
3-state 2-input NAND	3-state 2-input OR with two inverting inputs
3-state 2-input NAND with one inverting input	3-state 2-input OR with one inverting input
3-state 2-input NAND with two inverting inputs	3-state 2-input OR
3-state 2-input XOR	
3-state 2-input XNOR	3-state 2-input XOR with one inverting input

7.2 3-state buffer functions available

Table 6. Function table^[1]

See Figure 6.

Function	Input				
	\overline{OE}	A	B	C	D
3-state buffer	L	input	H or L	L	L
	L	H or L	input	H	L
	L	L	H	input	L
	L	H	L	input	H
	L	H	H or L	L	input
	L	H or L	L	H	input
	L	L	L	H or L	input

[1] H = HIGH voltage level;
L = LOW voltage level.

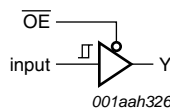

Fig 6. 3-state buffer function

7.3 3-state inverter functions available

Table 7. Function table^[1]
See Figure 7.

Function	Input				
	$\overline{\text{OE}}$	A	B	C	D
3-state inverter	L	input	H or L	L	H
	L	X	input	H	H
	L	L	H	input	H
	L	H	L	input	L
	L	H	H or L	L	input
	L	H or L	H	H	input
	L	H	H	H or L	input

[1] H = HIGH voltage level;
L = LOW voltage level.
X = don't care.

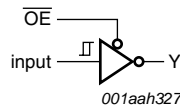

Fig 7. 3-state inverter function

7.4 3-state multiplexer functions available

Table 8. Function table^[1]
See Figure 8.

Function	Input				
	$\overline{\text{OE}}$	A	B	C	D
3-state 2-input multiplexer	L	input 1	input 2	$\overline{\text{input 1}}$ or input 2	L
	L	input 2	input 1	$\overline{\text{input 2}}$ or input 1	L
	L	input 1	input 2	$\overline{\text{input 1}}$ or input 2	H
	L	input 2	input 1	$\overline{\text{input 2}}$ or input 1	H

[1] H = HIGH voltage level;
L = LOW voltage level.

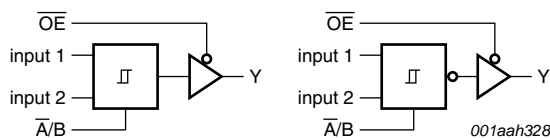

Fig 8. 3-state 2-input multiplexer function

7.5 3-state AND/NOR functions available

Table 9. Function table^[1]
See Figure 9.

Number of inputs	Function		Input				
	AND/NAND	OR/NOR	\overline{OE}	A	B	C	D
2	3-state AND	3-state NOR	L	L	input 1	input 2	L
2	3-state AND	3-state NOR	L	L	input 2	input 1	L

[1] H = HIGH voltage level;
L = LOW voltage level.

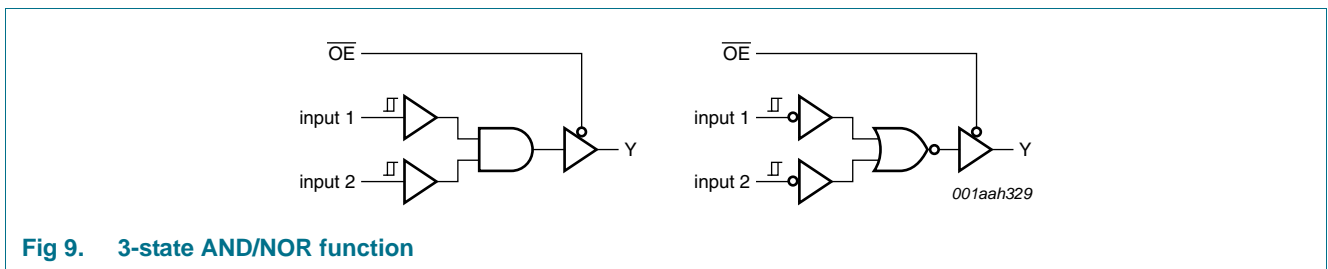

Fig 9. 3-state AND/NOR function

Table 10. Function table^[1]
See Figure 10.

Number of inputs	Function		Input				
	AND/NAND	OR/NOR	\overline{OE}	A	B	C	D
2	3-state AND	3-state NOR	L	input 2	L	input 1	L
2	3-state AND	3-state NOR	L	H	input 1	input 2	H

[1] H = HIGH voltage level;
L = LOW voltage level.

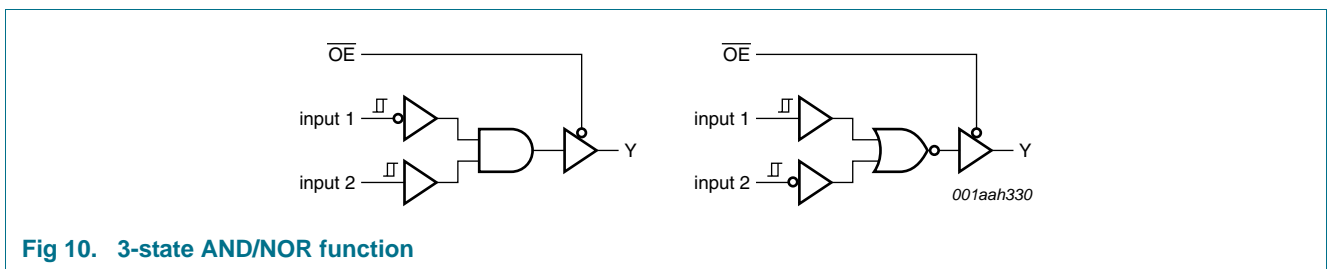

Fig 10. 3-state AND/NOR function

Table 11. Function table^[1]

See Figure 11.

Number of inputs	Function		Input				
	AND/NAND	OR/NOR	$\overline{\text{OE}}$	A	B	C	D
2	3-state AND	3-state NOR	L	input 1	L	input 2	L
2	3-state AND	3-state NOR	L	H	input 2	input 1	H

[1] H = HIGH voltage level;
L = LOW voltage level.

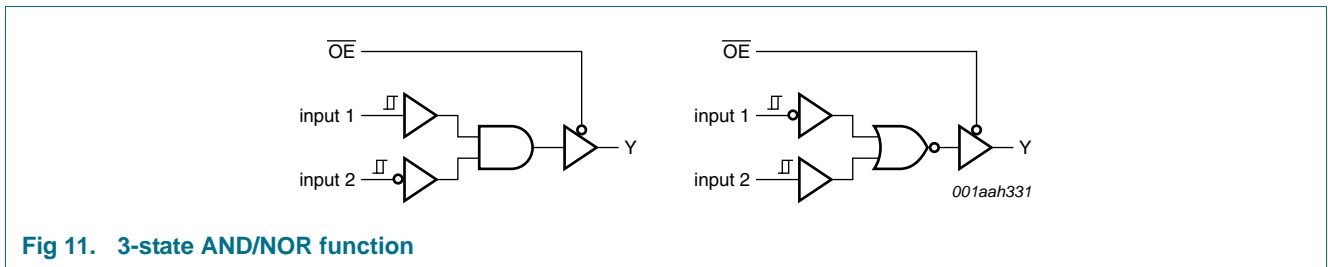

Fig 11. 3-state AND/NOR function

Table 12. Function table^[1]

See Figure 12.

Number of inputs	Function		Input				
	AND/NAND	OR/NOR	$\overline{\text{OE}}$	A	B	C	D
2	3-state AND	3-state NOR	L	input 1	H	input 2	L
2	3-state AND	3-state NOR	L	input 2	H	input 1	L

[1] H = HIGH voltage level;
L = LOW voltage level.

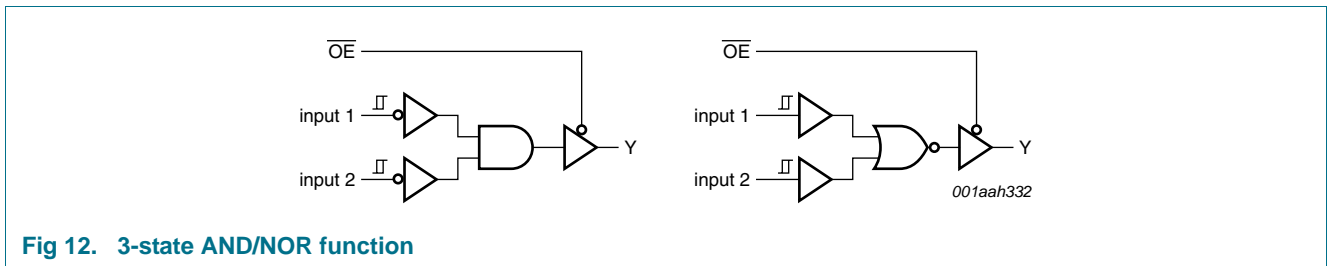

Fig 12. 3-state AND/NOR function

7.6 3-state NAND/OR functions available

Table 13. Function table^[1]

See Figure 13.

Number of inputs	Function		Input				
	AND/NAND	OR/NOR	\overline{OE}	A	B	C	D
2	3-state NAND	3-state OR	L	L	input 1	input 2	H
2	3-state NAND	3-state OR	L	L	input 2	input 1	H

[1] H = HIGH voltage level;
L = LOW voltage level.

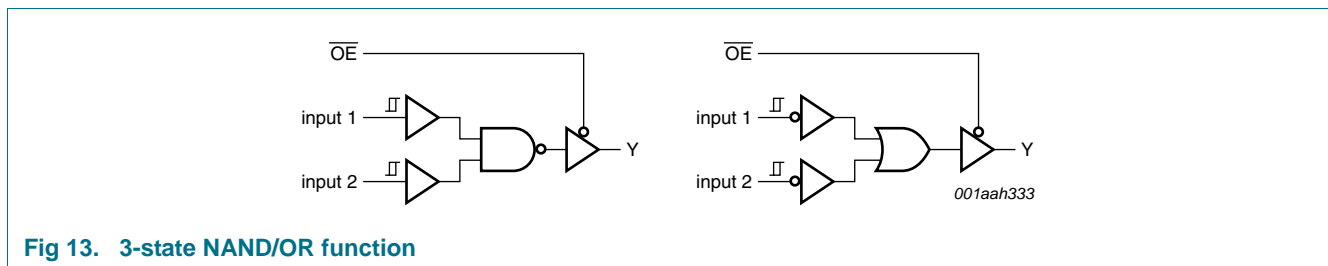

Fig 13. 3-state NAND/OR function

Table 14. Function table^[1]

See Figure 14.

Number of inputs	Function		Input				
	AND/NAND	OR/NOR	\overline{OE}	A	B	C	D
2	3-state NAND	3-state OR	L	input 2	L	input 1	H
2	3-state NAND	3-state OR	L	H	input 1	input 2	L

[1] H = HIGH voltage level;
L = LOW voltage level.

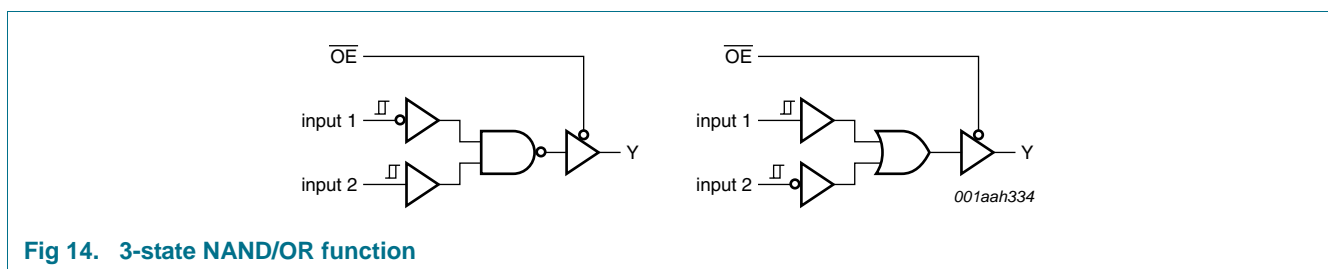

Fig 14. 3-state NAND/OR function

Table 15. Function table^[1]

See Figure 15.

Number of inputs	Function		Input				
	AND/NAND	OR/NOR	$\overline{\text{OE}}$	A	B	C	D
2	3-state NAND	3-state OR	L	input 1	L	input 2	H
2	3-state NAND	3-state OR	L	H	input 2	input 1	L

[1] H = HIGH voltage level;
L = LOW voltage level.

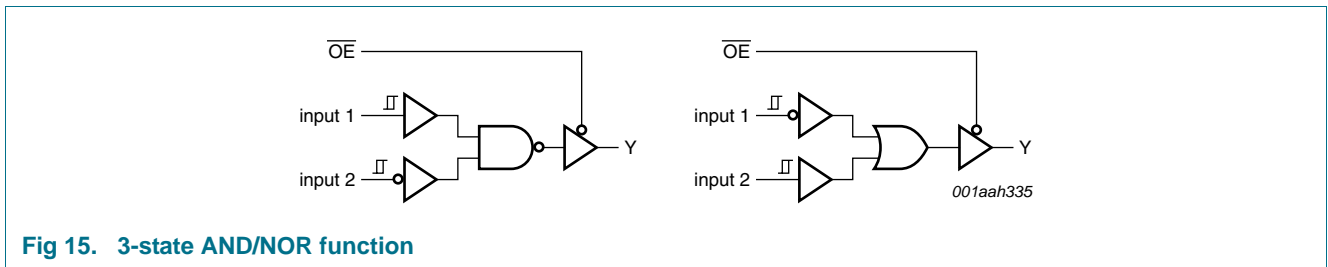

Fig 15. 3-state AND/NOR function

Table 16. Function table^[1]

See Figure 16.

Number of inputs	Function		Input				
	AND/NAND	OR/NOR	$\overline{\text{OE}}$	A	B	C	D
2	3-state NAND	3-state OR	L	input 1	H	input 2	L
2	3-state NAND	3-state OR	L	input 2	H	input 1	L

[1] H = HIGH voltage level;
L = LOW voltage level.

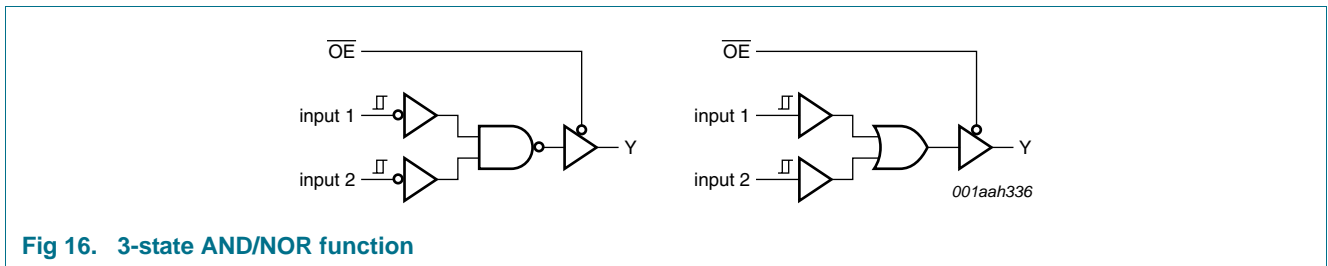

Fig 16. 3-state AND/NOR function

7.7 3-state XOR/XNOR functions available

Table 17. Function table^[1]
See Figure 17.

Function	Input				
	OE	A	B	C	D
3-state XOR	L	input 1	H or L	L	input 2
	L	input 2	H or L	L	input 1
	L	H or L	input 1	H	input 2
	L	H or L	input 2	H	input 1
	L	L	H	input 1	input 2
	L	L	H	input 2	input 1

[1] H = HIGH voltage level;
L = LOW voltage level.

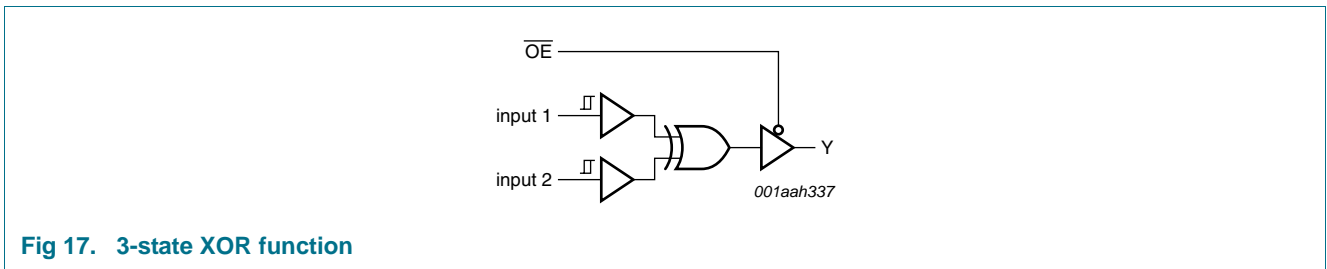

Fig 17. 3-state XOR function

Table 18. Function table^[1]
See Figure 18.

Function	Input				
	OE	A	B	C	D
3-state XOR	L	H	L	input 1	input 2

[1] H = HIGH voltage level;
L = LOW voltage level.

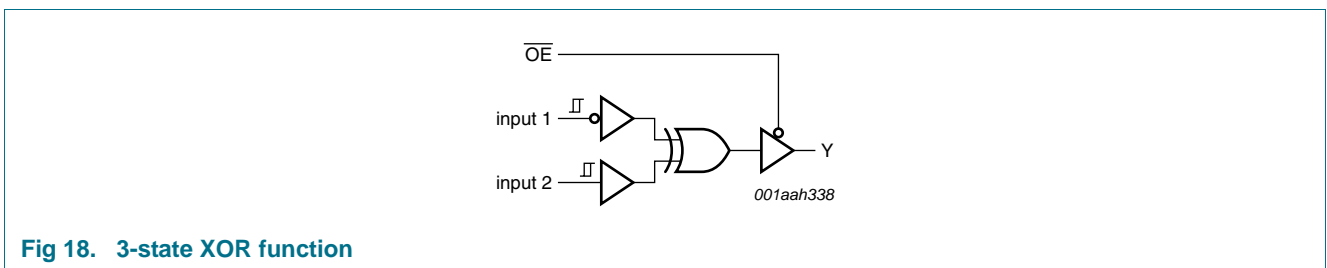

Fig 18. 3-state XOR function

Table 19. Function table^[1]

See Figure 19.

Function	Input				
	$\overline{\text{OE}}$	A	B	C	D
3-state XOR	L	H	L	input 1	input 2

[1] H = HIGH voltage level;
L = LOW voltage level.

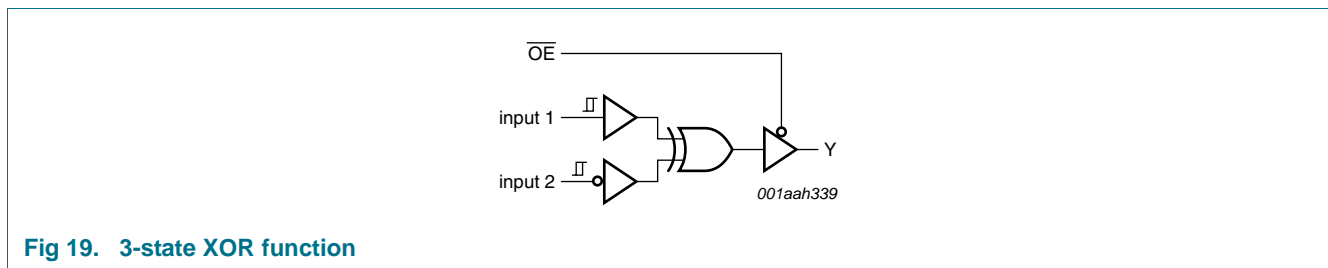

Fig 19. 3-state XOR function

Table 20. Function table^[1]

See Figure 20.

Function	Input				
	$\overline{\text{OE}}$	A	B	C	D
3-state XNOR	L	H	L	input 1	input 2
	L	H	L	input 2	input 1

[1] H = HIGH voltage level;
L = LOW voltage level.

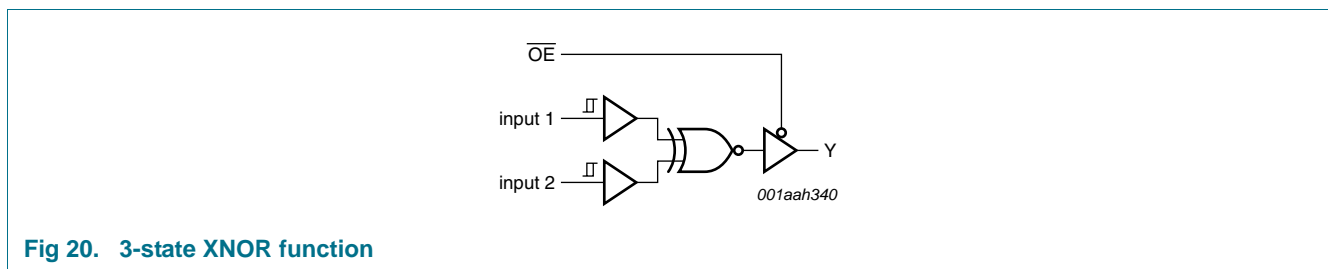

Fig 20. 3-state XNOR function

8. Limiting values

Table 21. Limiting values

In accordance with the Absolute Maximum Rating System (IEC 60134). Voltages are referenced to GND (ground = 0 V).

Symbol	Parameter	Conditions	Min	Max	Unit
V_{CC}	supply voltage		-0.5	+6.5	V
I_{IK}	input clamping current	$V_I < 0$ V	-50	-	mA
V_I	input voltage		[1] -0.5	+6.5	V
I_{OK}	output clamping current	$V_O > V_{CC}$ or $V_O < 0$ V	-	± 50	mA
V_O	output voltage	Active mode	[1][2] -0.5	$V_{CC} + 0.5$	V
		Power-down mode	[1][2] -0.5	+6.5	V
I_O	output current	$V_O = 0$ V to V_{CC}	-	± 50	mA
I_{CC}	supply current		-	100	mA
I_{GND}	ground current		-100	-	mA
P_{tot}	total power dissipation	$T_{amb} = -40$ °C to +125 °C	[3] -	250	mW
T_{stg}	storage temperature		-65	+150	°C

[1] The input and output voltage ratings may be exceeded if the input and output current ratings are observed.

[2] When $V_{CC} = 0$ V (Power-down mode), the output voltage can be 5.5 V in normal operation.

[3] For TSSOP8 package: above 110 °C the value of P_{tot} derates linearly with 8.0 mW/K.

For XSON8, XSON8U and XQFN8U packages: above 118 °C the value of P_{tot} derates linearly with 7.8 mW/K.

9. Recommended operating conditions

Table 22. Operating conditions

Symbol	Parameter	Conditions	Min	Max	Unit
V_{CC}	supply voltage		1.65	5.5	V
V_I	input voltage		0	5.5	V
V_O	output voltage	Active mode	0	V_{CC}	V
		Power-down mode; $V_{CC} = 0$ V	0	5.5	V
T_{amb}	ambient temperature		-40	+125	°C
$\Delta t/\Delta V$	input transition rise and fall rate	$V_{CC} = 1.65$ V to 2.7 V	-	20	ns/V
		$V_{CC} = 2.7$ V to 4.5 V	-	10	ns/V
		$V_{CC} = 4.5$ V to 5.5 V	-	5	ns/V

10. Static characteristics

Table 23. Static characteristics

At recommended operating conditions. Voltages are referenced to GND (ground = 0 V).

Symbol	Parameter	Conditions	Min	Typ ^[1]	Max	Unit
T_{amb} = -40 °C to +85 °C						
V _{OH}	HIGH-level output voltage	V _I = V _{T+} or V _{T-}				
		I _O = -100 μA; V _{CC} = 1.65 V to 5.5 V	V _{CC} - 0.1	-	-	V
		I _O = -4 mA; V _{CC} = 1.65 V	1.2	-	-	V
		I _O = -8 mA; V _{CC} = 2.3 V	1.9	-	-	V
		I _O = -12 mA; V _{CC} = 2.7 V	2.2	-	-	V
		I _O = -24 mA; V _{CC} = 3.0 V	2.3	-	-	V
		I _O = -32 mA; V _{CC} = 4.5 V	3.8	-	-	V
V _{OL}	LOW-level output voltage	V _I = V _{T+} or V _{T-}				
		I _O = 100 μA; V _{CC} = 1.65 V to 5.5 V	-	-	0.1	V
		I _O = 4 mA; V _{CC} = 1.65 V	-	-	0.45	V
		I _O = 8 mA; V _{CC} = 2.3 V	-	-	0.3	V
		I _O = 12 mA; V _{CC} = 2.7 V	-	-	0.4	V
		I _O = 24 mA; V _{CC} = 3.0 V	-	-	0.55	V
		I _O = 32 mA; V _{CC} = 4.5 V	-	-	0.55	V
I _I	input leakage current	V _{CC} = 0 V to 5.5 V; V _I = 5.5 V or GND	-	±0.1	±5	μA
I _{OZ}	OFF-state output current	V _{CC} = 3.6 V; V _I = V _{IH} or V _{IL} ; V _O = 5.5 V or GND	-	±0.1	±10	μA
I _{OFF}	power-off leakage current	V _{CC} = 0 V; V _I or V _O = 5.5 V	-	±0.1	±10	μA
I _{CC}	supply current	V _{CC} = 1.65 V to 5.5 V; V _I = 5.5 V or GND; I _O = 0 A	-	0.1	10	μA
ΔI _{CC}	additional supply current	per pin; V _{CC} = 2.3 V to 5.5 V; V _I = V _{CC} - 0.6 V; I _O = 0 A	-	5	500	μA
C _I	input capacitance	V _{CC} = 3.3 V; V _I = GND to V _{CC}	-	2.5	-	pF
T_{amb} = -40 °C to +125 °C						
V _{OH}	HIGH-level output voltage	V _I = V _{T+} or V _{T-}				
		I _O = -100 μA; V _{CC} = 1.65 V to 5.5 V	V _{CC} - 0.1	-	-	V
		I _O = -4 mA; V _{CC} = 1.65 V	0.95	-	-	V
		I _O = -8 mA; V _{CC} = 2.3 V	1.7	-	-	V
		I _O = -12 mA; V _{CC} = 2.7 V	1.9	-	-	V
		I _O = -24 mA; V _{CC} = 3.0 V	2.0	-	-	V
		I _O = -32 mA; V _{CC} = 4.5 V	3.4	-	-	V
V _{OL}	LOW-level output voltage	V _I = V _{T+} or V _{T-}				
		I _O = 100 μA; V _{CC} = 1.65 V to 5.5 V	-	-	0.1	V
		I _O = 4 mA; V _{CC} = 1.65 V	-	-	0.70	V
		I _O = 8 mA; V _{CC} = 2.3 V	-	-	0.45	V
		I _O = 12 mA; V _{CC} = 2.7 V	-	-	0.60	V
		I _O = 24 mA; V _{CC} = 3.0 V	-	-	0.80	V
		I _O = 32 mA; V _{CC} = 4.5 V	-	-	0.80	V

Table 23. Static characteristics ...continued

At recommended operating conditions. Voltages are referenced to GND (ground = 0 V).

Symbol	Parameter	Conditions	Min	Typ ^[1]	Max	Unit
I_I	input leakage current	$V_{CC} = 0\text{ V to }5.5\text{ V}$; $V_I = 5.5\text{ V or GND}$	-	-	± 100	μA
I_{OZ}	OFF-state output current	$V_{CC} = 3.6\text{ V}$; $V_I = V_{IH}$ or V_{IL} ; $V_O = 5.5\text{ V or GND}$	-	-	± 200	μA
I_{OFF}	power-off leakage current	$V_{CC} = 0\text{ V}$; V_I or $V_O = 5.5\text{ V}$	-	-	± 200	μA
I_{CC}	supply current	$V_{CC} = 1.65\text{ V to }5.5\text{ V}$; $V_I = 5.5\text{ V or GND}$; $I_O = 0\text{ A}$	-	-	200	μA
ΔI_{CC}	additional supply current	per pin; $V_{CC} = 2.3\text{ V to }5.5\text{ V}$; $V_I = V_{CC} - 0.6\text{ V}$; $I_O = 0\text{ A}$	-	-	5000	μA

[1] All typical values are measured at $V_{CC} = 3.3\text{ V}$ and $T_{amb} = 25\text{ }^\circ\text{C}$.

11. Dynamic characteristics

Table 24. Dynamic characteristicsVoltages are referenced to GND (ground = 0 V; for test circuit see [Figure 23](#)).

Symbol	Parameter	Conditions	25 °C			-40 °C to +125 °C			Unit
			Min	Typ ^[1]	Max	Min	Max (85 °C)	Max (125 °C)	
t_{pd}	propagation delay	A to Y; see Figure 21 ^[2]							
		$V_{CC} = 1.65\text{ V to }1.95\text{ V}$	-	7.5	-	2.8	30.8	38.5	ns
		$V_{CC} = 2.3\text{ V to }2.7\text{ V}$	-	5.0	-	2.0	11.7	14.6	ns
		$V_{CC} = 2.7\text{ V}$	-	5.4	-	2.0	9.0	11.3	ns
		$V_{CC} = 3.0\text{ V to }3.6\text{ V}$	-	4.5	-	1.8	8.4	10.5	ns
		$V_{CC} = 4.5\text{ V to }5.5\text{ V}$	-	3.8	-	1.8	5.5	6.9	ns
		B to Y; see Figure 21 ^[2]							
		$V_{CC} = 1.65\text{ V to }1.95\text{ V}$	-	7.5	-	2.8	28.9	36.2	ns
		$V_{CC} = 2.3\text{ V to }2.7\text{ V}$	-	5.0	-	2.0	11.3	14.2	ns
		$V_{CC} = 2.7\text{ V}$	-	5.4	-	2.0	9.0	11.3	ns
		$V_{CC} = 3.0\text{ V to }3.6\text{ V}$	-	4.5	-	1.8	8.2	10.3	ns
		$V_{CC} = 4.5\text{ V to }5.5\text{ V}$	-	3.8	-	1.8	5.4	6.8	ns
		C to Y; see Figure 21 ^[2]							
		$V_{CC} = 1.65\text{ V to }1.95\text{ V}$	-	7.8	-	3.2	29.8	37.3	ns
		$V_{CC} = 2.3\text{ V to }2.7\text{ V}$	-	5.2	-	2.3	12.3	15.4	ns
		$V_{CC} = 2.7\text{ V}$	-	5.3	-	2.3	9.6	12.0	ns
		$V_{CC} = 3.0\text{ V to }3.6\text{ V}$	-	4.6	-	2.3	8.6	10.8	ns
		$V_{CC} = 4.5\text{ V to }5.5\text{ V}$	-	3.8	-	1.8	5.7	7.2	ns
		D to Y; see Figure 21 ^[2]							
		$V_{CC} = 1.65\text{ V to }1.95\text{ V}$	-	7.0	-	2.8	25.7	32.2	ns
$V_{CC} = 2.3\text{ V to }2.7\text{ V}$	-	4.6	-	2.0	10.7	13.4	ns		
$V_{CC} = 2.7\text{ V}$	-	4.8	-	2.0	9.2	11.5	ns		
$V_{CC} = 3.0\text{ V to }3.6\text{ V}$	-	4.1	-	1.8	7.6	9.5	ns		
$V_{CC} = 4.5\text{ V to }5.5\text{ V}$	-	3.4	-	1.6	5.2	6.5	ns		

Table 24. Dynamic characteristics ...continuedVoltages are referenced to GND (ground = 0 V; for test circuit see [Figure 23](#)).

Symbol	Parameter	Conditions	25 °C			-40 °C to +125 °C			Unit
			Min	Typ ^[1]	Max	Min	Max (85 °C)	Max (125 °C)	
t _{en}	enable time	OE to Y; see Figure 22 ^[3]							
		V _{CC} = 1.65 V to 1.95 V	-	5.7	-	2.0	25.2	32.0	ns
		V _{CC} = 2.3 V to 2.7 V	-	3.8	-	1.4	11.3	14.0	ns
		V _{CC} = 2.7 V	-	4.2	-	1.4	8.6	11.0	ns
		V _{CC} = 3.0 V to 3.6 V	-	3.5	-	1.4	7.0	9.0	ns
		V _{CC} = 4.5 V to 5.5 V	-	2.7	-	1.4	4.7	6.0	ns
t _{dis}	disable time	OE to Y; see Figure 22 ^[4]							
		V _{CC} = 1.65 V to 1.95 V	-	5.7	-	3.0	15.0	19.0	ns
		V _{CC} = 2.3 V to 2.7 V	-	3.6	-	2.0	5.8	7.3	ns
		V _{CC} = 2.7 V	-	4.5	-	2.0	6.6	8.2	ns
		V _{CC} = 3.0 V to 3.6 V	-	4.5	-	2.1	5.9	7.4	ns
		V _{CC} = 4.5 V to 5.5 V	-	3.4	-	1.0	4.5	5.6	ns
C _{PD}	power dissipation capacitance	per buffer (output enabled); ^[5] f _i = 10 MHz; C _L = 50 pF; V _I = GND to V _{CC}							
		V _{CC} = 1.65 V to 1.95 V	-	14	-	-	-	-	pF
		V _{CC} = 2.3 V to 2.7 V	-	16	-	-	-	-	pF
		V _{CC} = 2.7 V	-	18	-	-	-	-	pF
		V _{CC} = 3.0 V to 3.6 V	-	25	-	-	-	-	pF
		V _{CC} = 4.5 V to 5.5 V	-	30	-	-	-	pF	

[1] All typical values are measured at nominal V_{CC}.[2] t_{pd} is the same as t_{PLH} and t_{PHL}.[3] t_{en} is the same as t_{PZH} and t_{PZL}.[4] t_{dis} is the same as t_{PHZ} and t_{PLZ}.[5] C_{PD} is used to determine the dynamic power dissipation (P_D in μW).
$$P_D = C_{PD} \times V_{CC}^2 \times f_i \times N + \Sigma(C_L \times V_{CC}^2 \times f_o)$$
 where:
f_i = input frequency in MHz;f_o = output frequency in MHz;C_L = output load capacitance in pF;V_{CC} = supply voltage in V;

N = number of inputs switching;

Σ(C_L × V_{CC}² × f_o) = sum of the outputs.

12. Waveforms

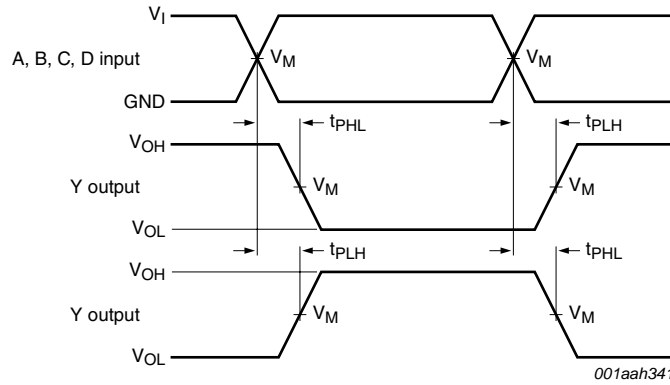

Measurement points are given in [Table 25](#).

Logic levels: V_{OL} and V_{OH} are typical output voltage drop that occur with the output load.

Fig 21. The data input (A, B, C, D) to output (Y) propagation delays

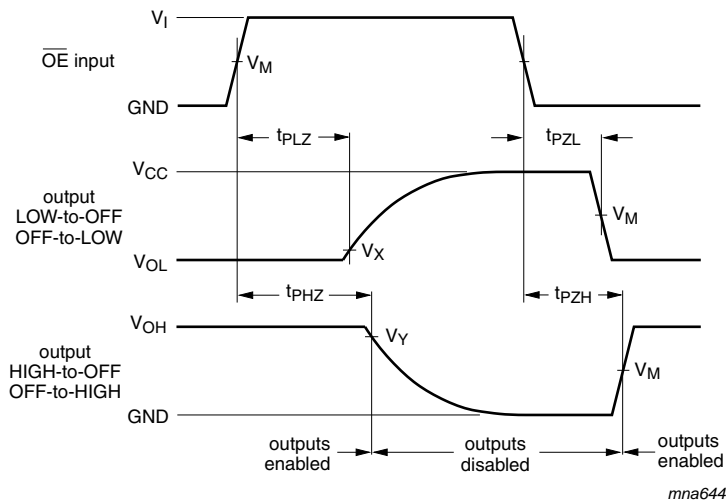

Measurement points are given in [Table 25](#).

Logic levels: V_{OL} and V_{OH} are typical output voltage drop that occur with the output load.

Fig 22. 3-state enable and disable times

Table 25. Measurement points

Supply voltage	Input	Output		
V_{CC}	V_M	V_M	V_X	V_Y
1.65 V to 1.95 V	$0.5V_{CC}$	$0.5V_{CC}$	$V_{OL} + 0.15 V$	$V_{OH} - 0.15 V$
2.3 V to 2.7 V	$0.5V_{CC}$	$0.5V_{CC}$	$V_{OL} + 0.15 V$	$V_{OH} - 0.15 V$
2.7 V	1.5 V	1.5 V	$V_{OL} + 0.3 V$	$V_{OH} - 0.3 V$
3.0 V to 3.6 V	1.5 V	1.5 V	$V_{OL} + 0.3 V$	$V_{OH} - 0.3 V$
4.5 V to 5.5 V	$0.5V_{CC}$	$0.5V_{CC}$	$V_{OL} + 0.3 V$	$V_{OH} - 0.3 V$

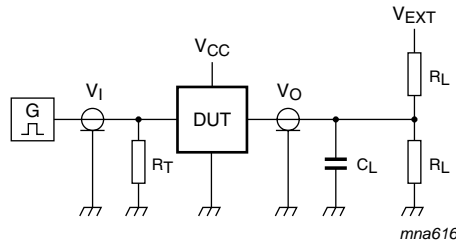

Test data is given in [Table 26](#).

Definitions for test circuit:

R_L = Load resistance.

C_L = Load capacitance including jig and probe capacitance.

R_T = Termination resistance should be equal to the output impedance Z_o of the pulse generator.

V_{EXT} = External voltage for measuring switching times.

Fig 23. Load circuitry for switching times

Table 26. Test data

Supply voltage	Input		Load		V_{EXT}		
	V_I	$t_r = t_f$	C_L	R_L	t_{PLH}, t_{PHL}	t_{PZH}, t_{PHZ}	t_{PZL}, t_{PLZ}
1.65 V to 1.95 V	V_{CC}	≤ 2.0 ns	30 pF	1 k Ω	open	GND	$2V_{CC}$
2.3 V to 2.7 V	V_{CC}	≤ 2.0 ns	30 pF	500 Ω	open	GND	$2V_{CC}$
2.7 V	2.7 V	≤ 2.5 ns	50 pF	500 Ω	open	GND	6 V
3.0 V to 3.6 V	2.7 V	≤ 2.5 ns	50 pF	500 Ω	open	GND	6 V
4.5 V to 5.5 V	V_{CC}	≤ 2.5 ns	50 pF	500 Ω	open	GND	$2V_{CC}$

13. Transfer characteristics

Table 27. Transfer characteristics

Voltages are referenced to GND (ground = 0 V; for test circuit see [Figure 23](#))

Symbol	Parameter	Conditions	-40 °C to +85 °C			-40 °C to +125 °C		Unit
			Min	Typ ^[1]	Max	Min	Max	
V_{T+}	positive-going threshold voltage	see Figure 24 , Figure 25 , Figure 26 , Figure 27 and Figure 28						
		$V_{CC} = 1.8$ V	0.70	1.02	1.20	0.67	1.20	V
		$V_{CC} = 2.3$ V	1.11	1.42	1.60	1.08	1.60	V
		$V_{CC} = 3.0$ V	1.50	1.79	2.00	1.47	2.00	V
		$V_{CC} = 4.5$ V	2.16	2.52	2.74	2.13	2.74	V
		$V_{CC} = 5.5$ V	2.61	2.99	3.33	2.58	3.33	V

Table 27. Transfer characteristics ...continued

Voltages are referenced to GND (ground = 0 V; for test circuit see [Figure 23](#))

Symbol	Parameter	Conditions	-40 °C to +85 °C			-40 °C to +125 °C		Unit
			Min	Typ ^[1]	Max	Min	Max	
V_{T-}	negative-going threshold voltage	see Figure 24 , Figure 25 , Figure 26 , Figure 27 and Figure 28						
		$V_{CC} = 1.8\text{ V}$	0.30	0.53	0.72	0.30	0.75	V
		$V_{CC} = 2.3\text{ V}$	0.58	0.77	1.00	0.58	1.03	V
		$V_{CC} = 3.0\text{ V}$	0.80	1.04	1.30	0.80	1.33	V
		$V_{CC} = 4.5\text{ V}$	1.21	1.55	1.90	1.21	1.93	V
		$V_{CC} = 5.5\text{ V}$	1.45	1.86	2.29	1.45	2.32	V
V_H	hysteresis voltage	$(V_{T+} - V_{T-})$; see Figure 24 , Figure 25 , Figure 26 , Figure 27 and Figure 28						
		$V_{CC} = 1.8\text{ V}$	0.30	0.48	0.62	0.23	0.62	V
		$V_{CC} = 2.3\text{ V}$	0.40	0.64	0.80	0.34	0.80	V
		$V_{CC} = 3.0\text{ V}$	0.50	0.75	1.00	0.44	1.00	V
		$V_{CC} = 4.5\text{ V}$	0.71	0.97	1.20	0.65	1.20	V
		$V_{CC} = 5.5\text{ V}$	0.71	1.13	1.40	0.65	1.40	V

[1] All typical values are measured at $T_{amb} = 25\text{ °C}$

14. Waveforms transfer characteristics

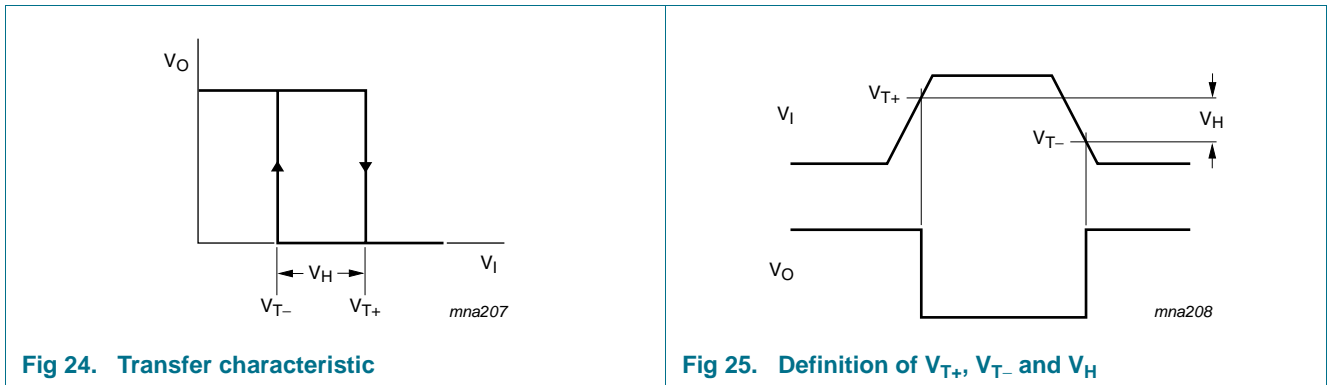

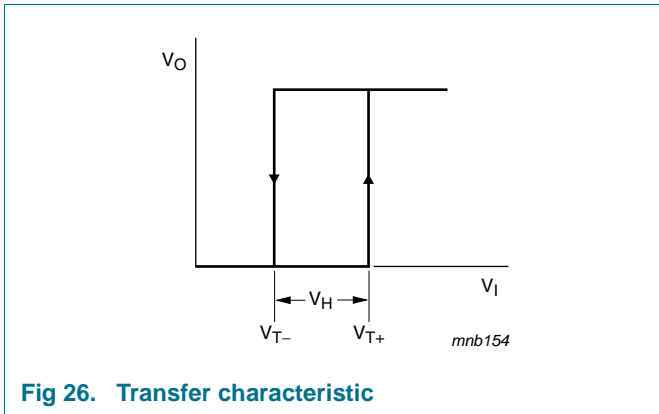

Fig 26. Transfer characteristic

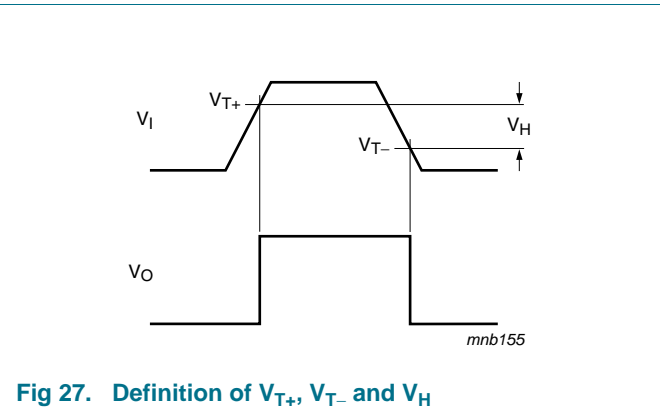

Fig 27. Definition of V_{T+} , V_{T-} and V_H

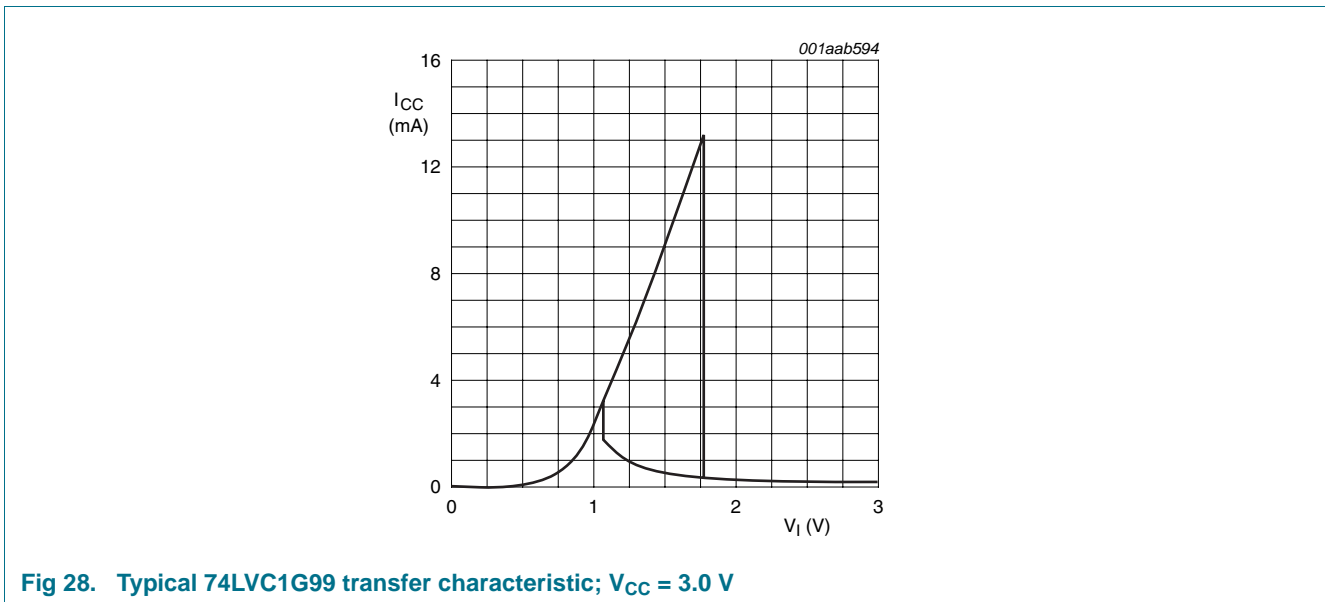

Fig 28. Typical 74LVC1G99 transfer characteristic; $V_{CC} = 3.0\text{ V}$

15. Package outline

TSSOP8: plastic thin shrink small outline package; 8 leads; body width 3 mm; lead length 0.5 mm SOT505-2

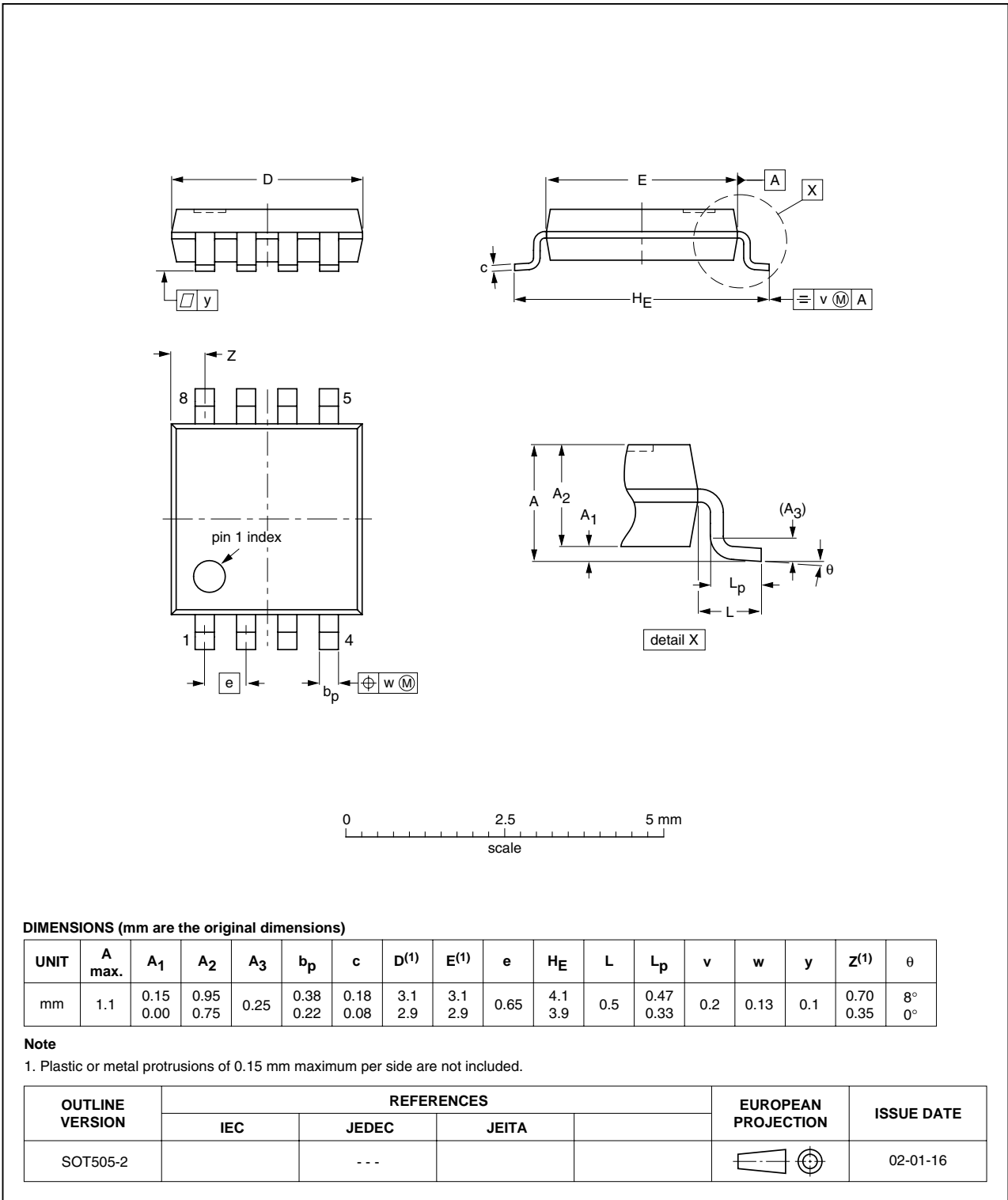

Fig 29. Package outline SOT505-2 (TSSOP8)

XSON8: plastic extremely thin small outline package; no leads; 8 terminals; body 1 x 1.95 x 0.5 mm

SOT833-1

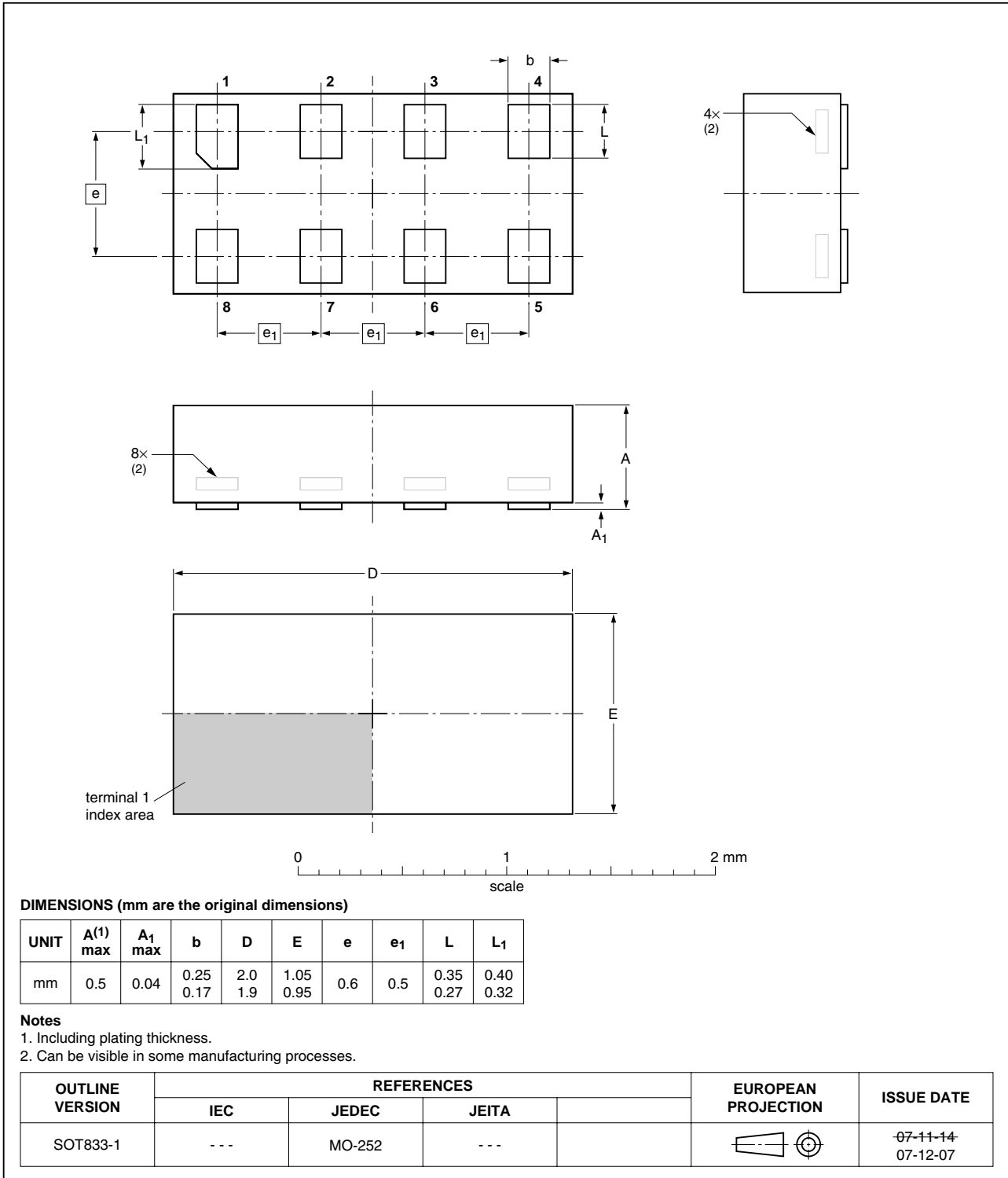

Fig 30. Package outline SOT833-1 (XSON8)

XSON8: extremely thin small outline package; no leads;
8 terminals; body 1.35 x 1 x 0.5 mm

SOT1089

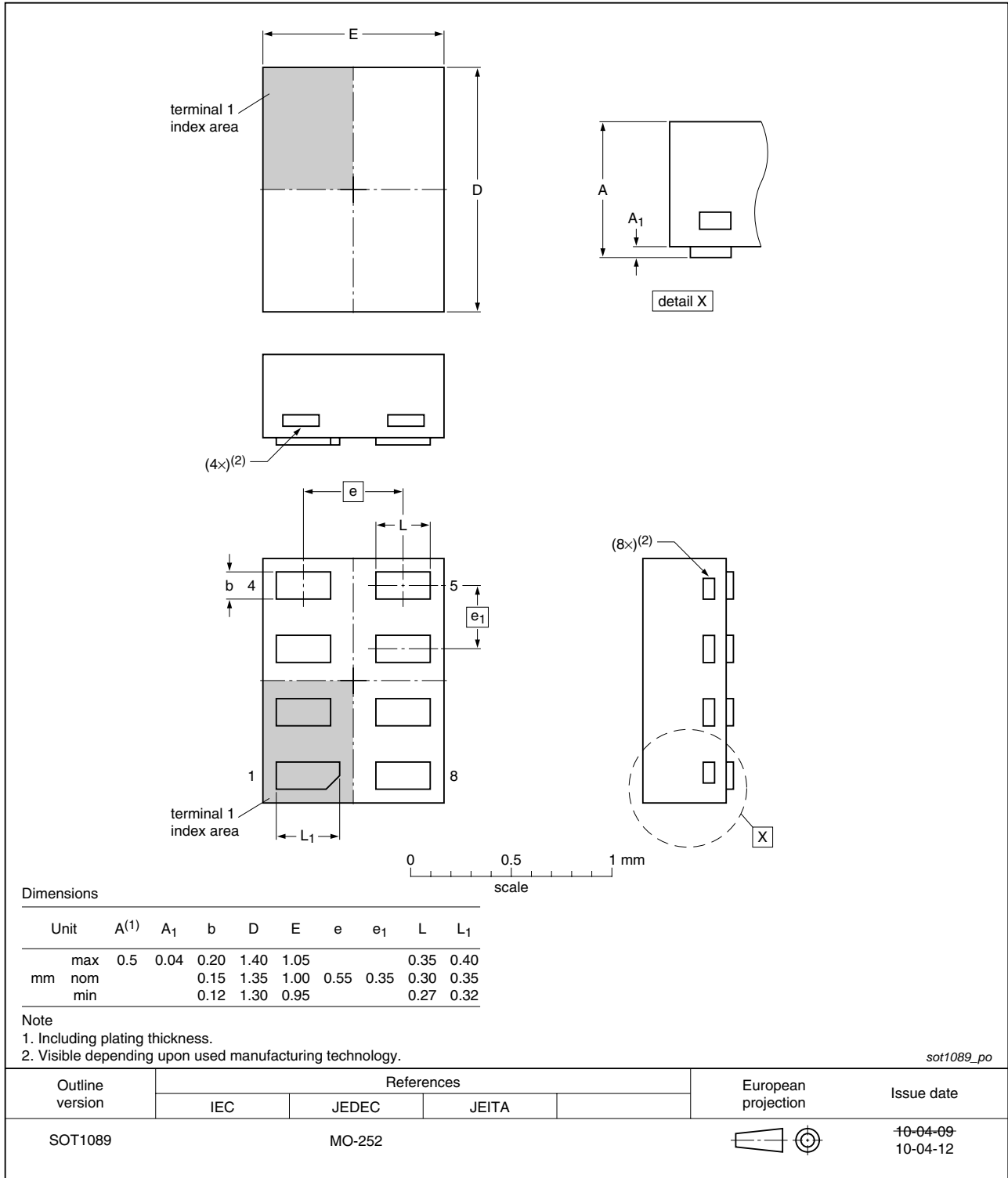

Fig 31. Package outline SOT1089 (XSON8)

XSON8U: plastic extremely thin small outline package; no leads;
8 terminals; UTLP based; body 3 x 2 x 0.5 mm

SOT996-2

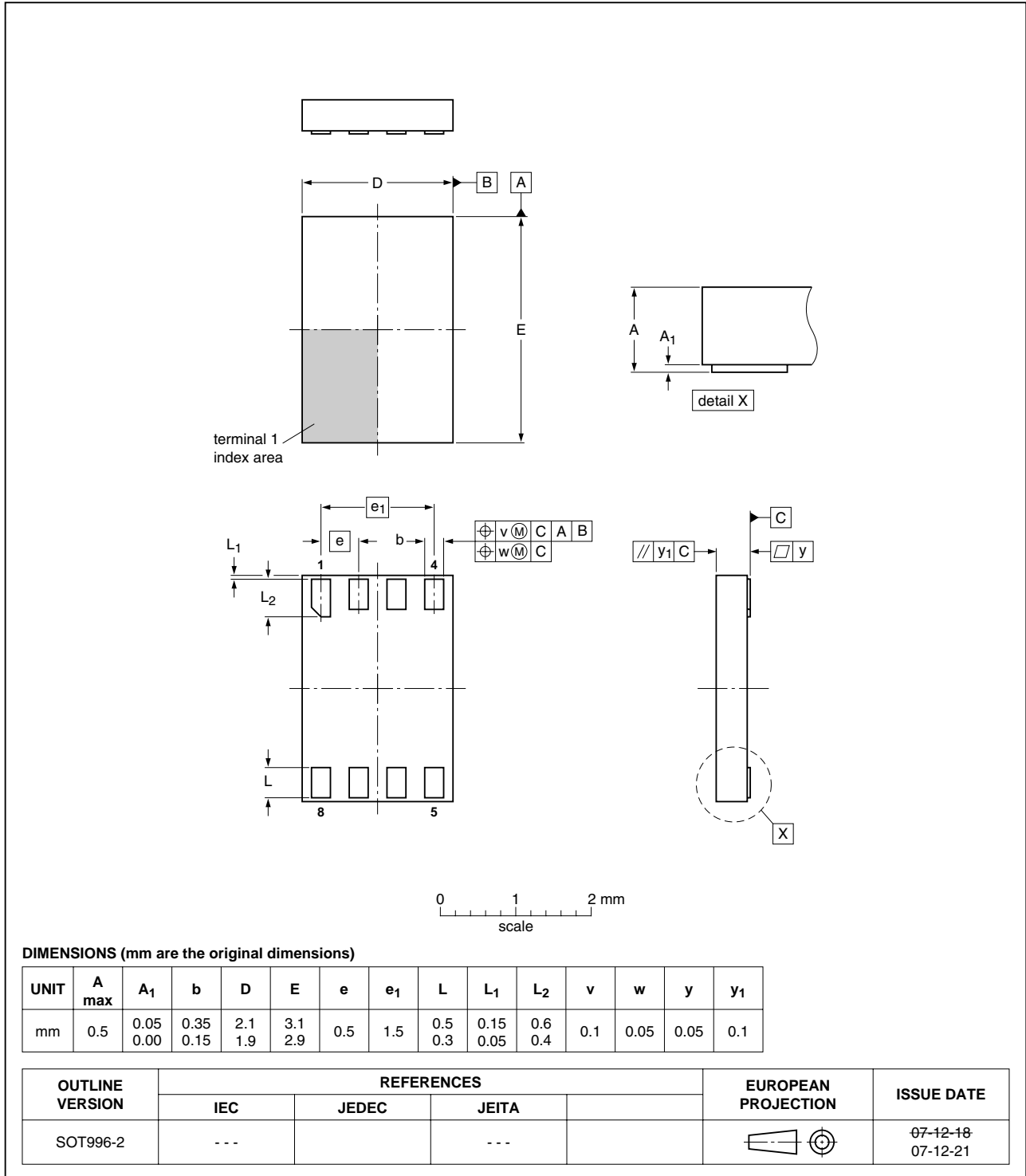

Fig 32. Package outline SOT996-2 (XSON8U)

XQFN8U: plastic extremely thin quad flat package; no leads;
8 terminals; UTLP based; body 1.6 x 1.6 x 0.5 mm

SOT902-1

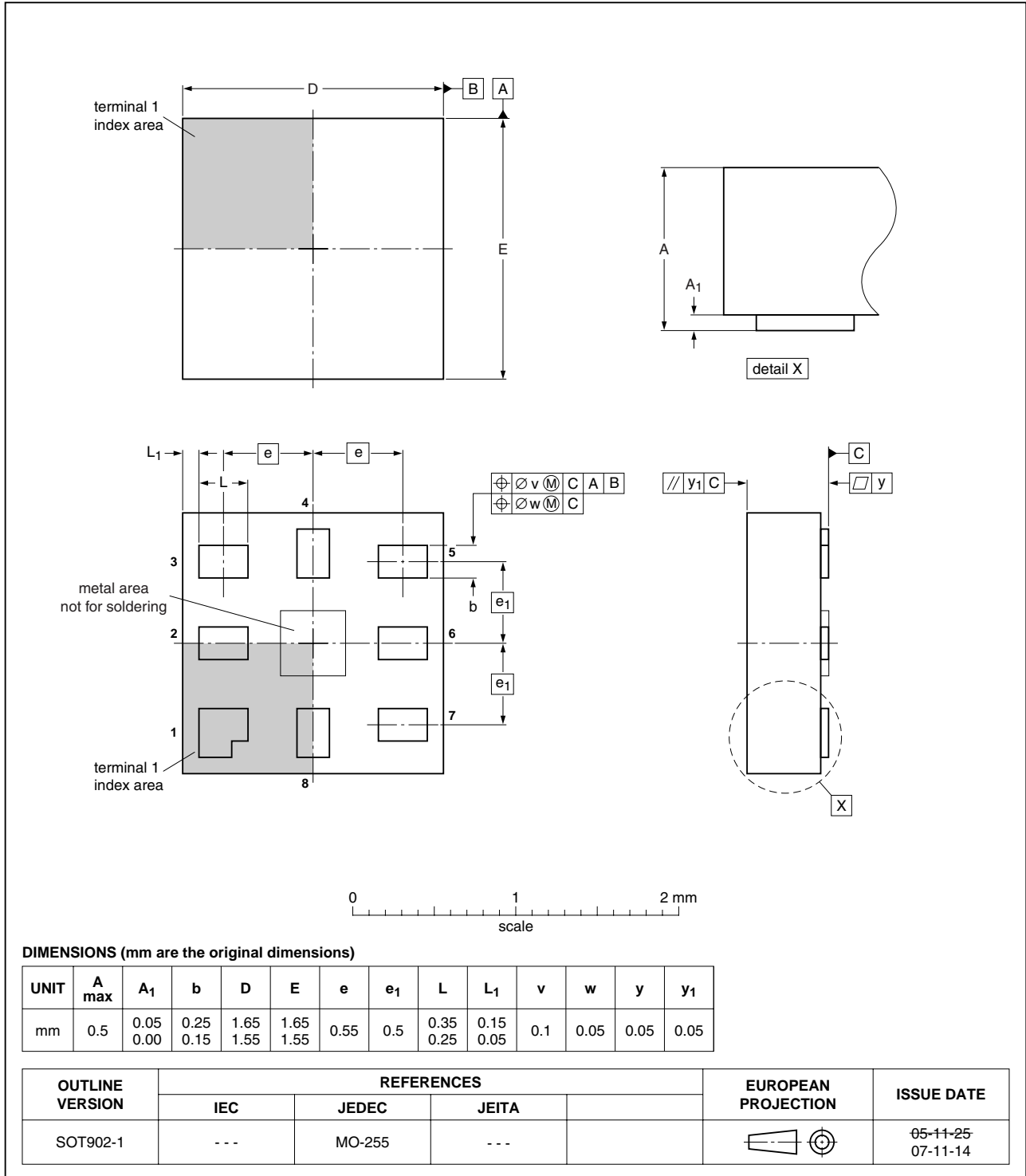

Fig 33. Package outline SOT902-1 (XQFN8U)

16. Abbreviations

Table 28. Abbreviations

Acronym	Description
CMOS	Complementary Metal-Oxide Semiconductor
DUT	Device Under Test
ESD	ElectroStatic Discharge
HBM	Human Body Model
MM	Machine Model
TTL	Transistor-Transistor Logic

17. Revision history

Table 29. Revision history

Document ID	Release date	Data sheet status	Change notice	Supersedes
74LVC1G99_4	20100416	Product data sheet	-	74LVC1G99_3
Modifications:	• Added type number 74LVC1G99GD (XSON8U package)			
74LVC1G99_3	20091203	Product data sheet	-	74LVC1G99_2
74LVC1G99_2	20080208	Product data sheet	-	74LVC1G99_1
74LVC1G99_1	20080103	Product data sheet	-	-

18. Legal information

18.1 Data sheet status

Document status ^{[1][2]}	Product status ^[3]	Definition
Objective [short] data sheet	Development	This document contains data from the objective specification for product development.
Preliminary [short] data sheet	Qualification	This document contains data from the preliminary specification.
Product [short] data sheet	Production	This document contains the product specification.

[1] Please consult the most recently issued document before initiating or completing a design.

[2] The term 'short data sheet' is explained in section "Definitions".

[3] The product status of device(s) described in this document may have changed since this document was published and may differ in case of multiple devices. The latest product status information is available on the Internet at URL <http://www.nxp.com>.

18.2 Definitions

Draft — The document is a draft version only. The content is still under internal review and subject to formal approval, which may result in modifications or additions. NXP Semiconductors does not give any representations or warranties as to the accuracy or completeness of information included herein and shall have no liability for the consequences of use of such information.

Short data sheet — A short data sheet is an extract from a full data sheet with the same product type number(s) and title. A short data sheet is intended for quick reference only and should not be relied upon to contain detailed and full information. For detailed and full information see the relevant full data sheet, which is available on request via the local NXP Semiconductors sales office. In case of any inconsistency or conflict with the short data sheet, the full data sheet shall prevail.

Product specification — The information and data provided in a Product data sheet shall define the specification of the product as agreed between NXP Semiconductors and its customer, unless NXP Semiconductors and customer have explicitly agreed otherwise in writing. In no event however, shall an agreement be valid in which the NXP Semiconductors product is deemed to offer functions and qualities beyond those described in the Product data sheet.

18.3 Disclaimers

Limited warranty and liability — Information in this document is believed to be accurate and reliable. However, NXP Semiconductors does not give any representations or warranties, expressed or implied, as to the accuracy or completeness of such information and shall have no liability for the consequences of use of such information.

In no event shall NXP Semiconductors be liable for any indirect, incidental, punitive, special or consequential damages (including - without limitation - lost profits, lost savings, business interruption, costs related to the removal or replacement of any products or rework charges) whether or not such damages are based on tort (including negligence), warranty, breach of contract or any other legal theory.

Notwithstanding any damages that customer might incur for any reason whatsoever, NXP Semiconductors' aggregate and cumulative liability towards customer for the products described herein shall be limited in accordance with the *Terms and conditions of commercial sale* of NXP Semiconductors.

Right to make changes — NXP Semiconductors reserves the right to make changes to information published in this document, including without limitation specifications and product descriptions, at any time and without notice. This document supersedes and replaces all information supplied prior to the publication hereof.

Suitability for use in automotive applications — This NXP Semiconductors product has been qualified for use in automotive applications. The product is not designed, authorized or warranted to be

suitable for use in medical, military, aircraft, space or life support equipment, nor in applications where failure or malfunction of an NXP Semiconductors product can reasonably be expected to result in personal injury, death or severe property or environmental damage. NXP Semiconductors accepts no liability for inclusion and/or use of NXP Semiconductors products in such equipment or applications and therefore such inclusion and/or use is at the customer's own risk.

Applications — Applications that are described herein for any of these products are for illustrative purposes only. NXP Semiconductors makes no representation or warranty that such applications will be suitable for the specified use without further testing or modification.

NXP Semiconductors does not accept any liability related to any default, damage, costs or problem which is based on a weakness or default in the customer application/use or the application/use of customer's third party customer(s) (hereinafter both referred to as "Application"). It is customer's sole responsibility to check whether the NXP Semiconductors product is suitable and fit for the Application planned. Customer has to do all necessary testing for the Application in order to avoid a default of the Application and the product. NXP Semiconductors does not accept any liability in this respect.

Limiting values — Stress above one or more limiting values (as defined in the Absolute Maximum Ratings System of IEC 60134) will cause permanent damage to the device. Limiting values are stress ratings only and (proper) operation of the device at these or any other conditions above those given in the Recommended operating conditions section (if present) or the Characteristics sections of this document is not warranted. Constant or repeated exposure to limiting values will permanently and irreversibly affect the quality and reliability of the device.

Terms and conditions of commercial sale — NXP Semiconductors products are sold subject to the general terms and conditions of commercial sale, as published at <http://www.nxp.com/profile/terms>, unless otherwise agreed in a valid written individual agreement. In case an individual agreement is concluded only the terms and conditions of the respective agreement shall apply. NXP Semiconductors hereby expressly objects to applying the customer's general terms and conditions with regard to the purchase of NXP Semiconductors products by customer.

No offer to sell or license — Nothing in this document may be interpreted or construed as an offer to sell products that is open for acceptance or the grant, conveyance or implication of any license under any copyrights, patents or other industrial or intellectual property rights.

Export control — This document as well as the item(s) described herein may be subject to export control regulations. Export might require a prior authorization from national authorities.

18.4 Trademarks

Notice: All referenced brands, product names, service names and trademarks are the property of their respective owners.

19. Contact information

For more information, please visit: <http://www.nxp.com>

For sales office addresses, please send an email to: salesaddresses@nxp.com

20. Contents

1	General description	1
2	Features and benefits	1
3	Ordering information	2
4	Marking	2
5	Functional diagram	2
6	Pinning information	3
6.1	Pinning	3
6.2	Pin description	4
7	Functional description	4
7.1	Logic configurations	5
7.2	3-state buffer functions available	5
7.3	3-state inverter functions available	6
7.4	3-state multiplexer functions available	6
7.5	3-state AND/NOR functions available	7
7.6	3-state NAND/OR functions available	9
7.7	3-state XOR/XNOR functions available	11
8	Limiting values	13
9	Recommended operating conditions	13
10	Static characteristics	14
11	Dynamic characteristics	15
12	Waveforms	17
13	Transfer characteristics	18
14	Waveforms transfer characteristics	19
15	Package outline	21
16	Abbreviations	26
17	Revision history	26
18	Legal information	27
18.1	Data sheet status	27
18.2	Definitions	27
18.3	Disclaimers	27
18.4	Trademarks	27
19	Contact information	28
20	Contents	29

Please be aware that important notices concerning this document and the product(s) described herein, have been included in section 'Legal information'.

© NXP B.V. 2010.

All rights reserved.

For more information, please visit: <http://www.nxp.com>

For sales office addresses, please send an email to: salesaddresses@nxp.com

Date of release: 16 April 2010

Document identifier: 74LVC1G99_4