

74LVQ273 Low Voltage Octal D-Type Flip-Flop

General Description

The LVQ273 has eight edge-triggered D-type flip-flops with individual D inputs and Q outputs. The common buffered Clock (CP) and Master Reset (\overline{MR}) input load and reset (clear) all flip-flops simultaneously.

The register is fully edge-triggered. The state of each D input, one setup time before the LOW-to-HIGH clock transition, is transferred to the corresponding flip-flop's Q output.

All outputs will be forced LOW independently of Clock or Data inputs by a LOW voltage level on the \overline{MR} input. The device is useful for applications where the true output only is required and the Clock and Master Reset are common to all storage elements.

Features

- Ideal for low power/low noise 3.3V applications
- Implements patented EMI reduction circuitry
- Available in SOIC JEDEC, SOIC EIAJ and QSOP packages
- Guaranteed simultaneous switching noise level and dynamic threshold performance
- Improved latch-up immunity
- Guaranteed incident wave switching into 75Ω
- 4 kV minimum ESD immunity

Ordering Code:

Order Number	Package Number	Package Description
74LVQ273SC	M20B	20-Lead (0.300" Wide) Molded Small Outline Package, SOIC JEDEC
74LVQ273SJ	M20D	20-Lead Shrink Molded Small Outline Package, SOIC EIAJ
74LVQ273QSC	MQA20	20-Lead (0.150" Wide) Molded Shrink Small Outline Package, SSOP JEDEC

Devices also available in Tape and Reel. Specify by appending suffix letter "X" to the ordering code.

Logic Symbol

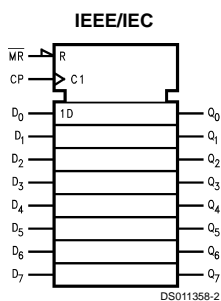
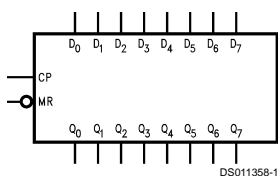

Connection Diagram

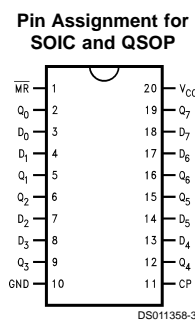

Pin Descriptions

Pin Names	Description
D ₀ -D ₇	Data Inputs
\overline{MR}	Master Reset
CP	Clock Pulse Input
Q ₀ -Q ₇	Data Outputs

Absolute Maximum Ratings (Note 1)

Supply Voltage (V_{CC})	-0.5V to +7.0V
DC Input Diode Current (I_{IK})	
$V_I = -0.5V$	-20 mA
$V_I = V_{CC} + 0.5V$	+20 mA
DC Input Voltage (V_I)	-0.5V to $V_{CC} + 0.5V$
DC Output Diode Current (I_{OK})	
$V_O = -0.5V$	-20 mA
$V_O = V_{CC} + 0.5V$	+20 mA
DC Output Voltage (V_O)	-0.5V to $V_{CC} + 0.5V$
DC Output Source	
or Sink Current (I_O)	± 50 mA
DC V_{CC} or Ground Current	
(I_{CC} or I_{GND})	± 400 mA
Storage Temperature (T_{STG})	-65°C to +150°C
DC Latch-up Source or	
Sink Current	± 300 mA

Recommended Operating Conditions (Note 2)

Supply Voltage (V_{CC})	2.0V to 3.6V
Input Voltage (V_I)	0V to V_{CC}
Output Voltage (V_O)	0V to V_{CC}
Operating Temperature (T_A)	-40°C to +85°C
Minimum Input Edge Rate $\Delta V/\Delta t$	
V_{IN} from 0.8V to 2.0V	
V_{CC} @ 3.0V	125 mV/ns

Note 1: The "Absolute Maximum Ratings" are those values beyond which the safety of the device cannot be guaranteed. The device should not be operated at these limits. The parametric values defined in the Electrical Characteristics tables are not guaranteed at the absolute maximum ratings. The "Recommended Operating Conditions" table will define the conditions for actual device operation.

Note 2: Unused inputs must be held HIGH or LOW. They may not float.

DC Electrical Characteristics

Symbol	Parameter	V_{CC} (V)	$T_A = +25^\circ\text{C}$		$T_A = -40^\circ\text{C to } +85^\circ\text{C}$	Units	Conditions
			Typ	Guaranteed Limits			
V_{IH}	Minimum High Level Input Voltage	3.0	1.5	2.0	2.0	V	$V_{OUT} = 0.1V$ or $V_{CC} - 0.1V$
V_{IL}	Maximum Low Level Input Voltage	3.0	1.5	0.8	0.8	V	$V_{OUT} = 0.1V$ or $V_{CC} - 0.1V$
V_{OH}	Minimum High Level Output Voltage	3.0	2.99	2.9	2.9	V	$I_{OUT} = -50 \mu\text{A}$
		3.0		2.58	2.48	V	$V_{IN} = V_{IL}$ or V_{IH} (Note 3) $I_{OH} = -12 \text{ mA}$
V_{OL}	Maximum Low Level Output Voltage	3.0	0.002	0.1	0.1	V	$I_{OUT} = 50 \mu\text{A}$
		3.0		0.36	0.44	V	$V_{IN} = V_{IL}$ or V_{IH} (Note 3) $I_{OL} = 12 \text{ mA}$
I_{IN}	Maximum Input Leakage Current	3.6		± 0.1	± 1.0	μA	$V_I = V_{CC}, \text{ GND}$
I_{OLD}	Minimum Dynamic	3.6			36	mA	$V_{OLD} = 0.8V$ Max (Note 5)
I_{OHD}	Output Current (Note 4)	3.6			-25	mA	$V_{OHD} = 2.0V$ Min (Note 5)
I_{CC}	Maximum Quiescent Supply Current	3.6		4.0	40.0	μA	$V_{IN} = V_{CC}$ or GND
V_{OLP}	Quiet Output Maximum Dynamic V_{OL}	3.3	0.4	0.8		V	(Notes 6, 7)
V_{OLV}	Quiet Output Minimum Dynamic V_{OL}	3.3	-0.3	-0.8		V	(Notes 6, 7)
V_{IHD}	Maximum High Level Dynamic Input Voltage	3.3	1.7	2.0		V	(Notes 6, 8)
V_{ILD}	Maximum Low Level Dynamic Input Voltage	3.3	1.6	0.8		V	(Notes 6, 8)

Note 3: All outputs loaded; thresholds on input associated with output under test.

Note 4: Maximum test duration 2.0 ms, one output loaded at a time.

Note 5: Incident wave switching on transmission lines with impedances as low as 75Ω for commercial temperature range is guaranteed for.

Note 6: Worst case package.

Note 7: Max number of outputs defined as (n). Data Inputs are driven 0V to 3.3V; one output at GND.

Note 8: Max number of Data Inputs (n) switching. (n - 1) inputs switching 0V to 3.3V. Input-under-test switching: 3.3V to threshold (V_{ILD}), 0V to threshold (V_{IHD}), f = 1 MHz.

AC Electrical Characteristics

Symbol	Parameter	V _{CC} (V)	T _A = +25°C			T _A = -40°C to +85°C		Units
			C _L = 50 pF			C _L = 50 pF		
			Min	Typ	Max	Min	Max	
f _{max}	Maximum Clock Frequency	2.7 3.3 ±0.3	50 90			45 75		MHz
t _{PLH}	Propagation Delay CP to Q _n	2.7 3.3 ±0.3	4.0 4.0	9.6 8.0	17.6 12.5	3.0 3.0	20.0 14.0	ns
t _{PHL}	Propagation Delay CP to Q _n	2.7 3.3 ±0.3	4.0 4.0	10.2 8.5	18.3 13.0	3.5 3.5	20.5 14.5	ns
t _{PHL}	Propagation Delay \overline{MR} to Q _n	2.7 3.3 ±0.3	4.0 4.0	10.2 8.5	18.3 13.0	3.5 3.5	20.0 14.0	ns
t _{OSSL}	Output to Output Skew (Note 9)	2.7 3.3 ±0.3		1.0 1.0	1.5 1.5		1.5 1.5	ns

Note 9: Skew is defined as the absolute value of the difference between the actual propagation delay for any two outputs within the same packaged device. The specification applies to any outputs switching in the same direction, either HIGH to LOW (t_{OSSL}) or LOW to HIGH (t_{OSLH}). Parameter guaranteed by design. Not tested.

AC Operating Requirements

Symbol	Parameter	V _{CC} (V)	T _A = +25°C		T _A = -40°C to +85°C		Units
			C _L = 50 pF		C _L = 50 pF		
			Typ	Guaranteed Minimum			
t _S	Setup Time, HIGH or LOW D _n to CP	2.7 3.3 ±0.3		6.5 5.0	8.5 6.0		ns
t _H	Hold Time, HIGH or LOW D _n to CP	2.7 3.3 ±0.3		0.0 0.0	0.0 0.0		ns
t _W	Clock Pulse Width HIGH or LOW	2.7 3.3 ±0.3		7.0 5.5	8.5 6.0		ns
t _W	\overline{MR} Pulse Width HIGH or LOW	2.7 3.3 ±0.3		7.0 5.5	8.5 6.0		ns
t _W	Recovery Time \overline{MR} to CP	2.7 3.3 ±0.3		5.0 4.0	6.5 4.5		ns

Capacitance

Symbol	Parameter	Typ	Units	Conditions
C _{IN}	Input Capacitance	4.5	pF	V _{CC} = Open
C _{PD} (Note 10)	Power Dissipation Capacitance	35	pF	V _{CC} = 3.3V

Note 10: C_{PD} is measured at 10 MHz.



Physical Dimensions inches (millimeters) unless otherwise noted

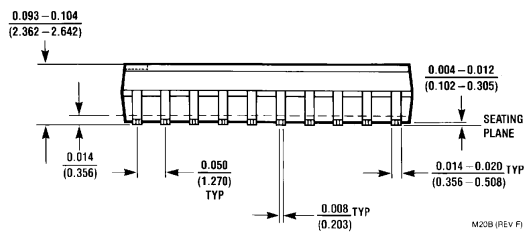
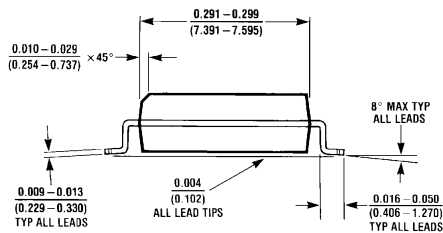
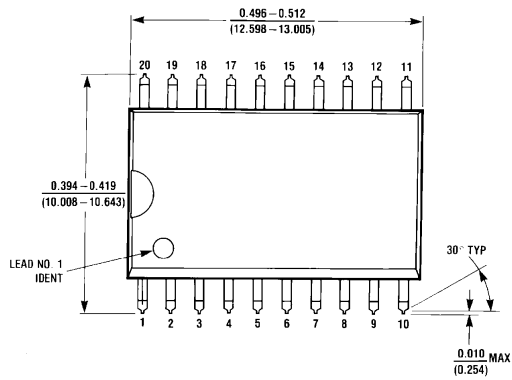

20-Lead (0.300" Wide) Molded Small Outline Package, SOIC JEDEC
Package Number M20B

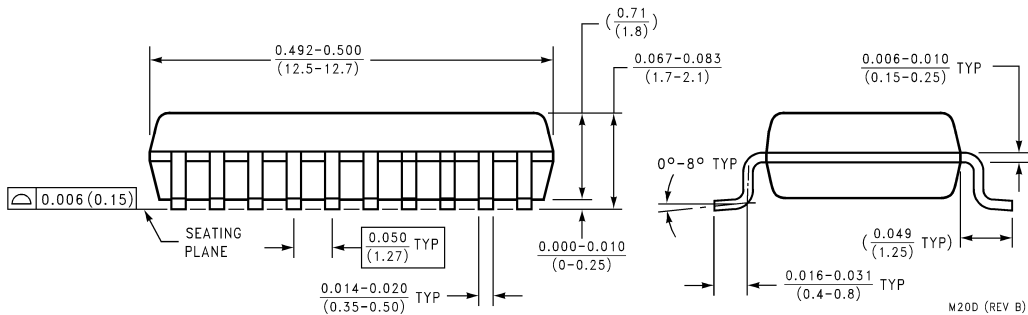
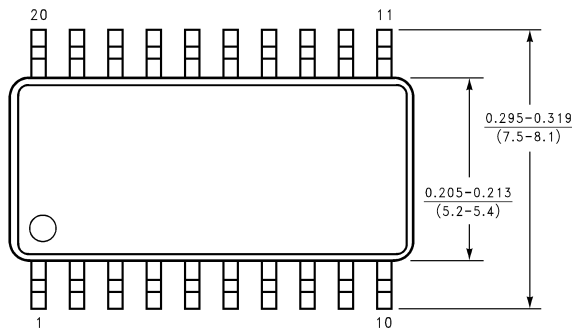

20-Lead Shrink Molded Small Outline Package, SOIC EIAJ
Package Number M20D

74LVQ273 Low Voltage Octal D-Type Flip-Flop

Physical Dimensions inches (millimeters) unless otherwise noted (Continued)

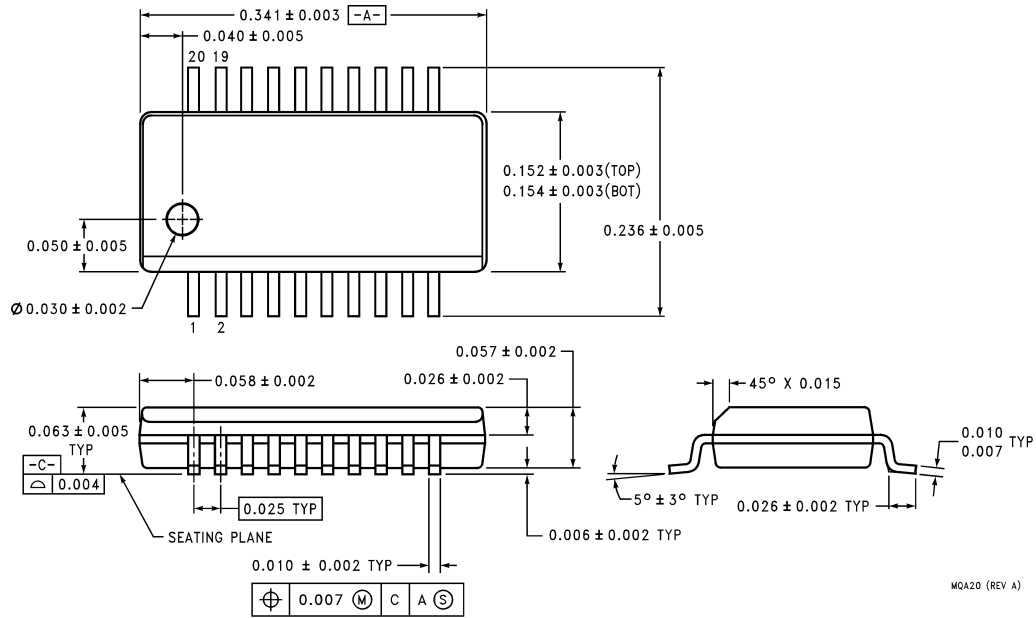

**20-Lead (0.150" Wide) Molded Shrink Small Outline Package, SSOP JEDEC
(also known as QSOP)
Package Number MQA20**

LIFE SUPPORT POLICY

FAIRCHILD'S PRODUCTS ARE NOT AUTHORIZED FOR USE AS CRITICAL COMPONENTS IN LIFE SUPPORT DEVICES OR SYSTEMS WITHOUT THE EXPRESS WRITTEN APPROVAL OF THE PRESIDENT OF FAIRCHILD SEMICONDUCTOR CORPORATION. As used herein:

1. Life support devices or systems are devices or systems which, (a) are intended for surgical implant into the body, or (b) support or sustain life, and (c) whose failure to perform when properly used in accordance with instructions for use provided in the labeling, can be reasonably expected to result in a significant injury to the user.
2. A critical component in any component of a life support device or system whose failure to perform can be reasonably expected to cause the failure of the life support device or system, or to affect its safety or effectiveness.

Fairchild Semiconductor Corporation Americas
Customer Response Center
Tel: 1-888-522-5372

Fairchild Semiconductor Europe
Fax: +49 (0) 1 80-530 85 86
Email: europe.support@nsc.com
Deutsch Tel: +49 (0) 8 141-35-0
English Tel: +44 (0) 1 793-85-68-56
Italy Tel: +39 (0) 2 57 5631

Fairchild Semiconductor Hong Kong Ltd.
13th Floor, Straight Block,
Ocean Centre, 5 Canton Rd.
Tsimshatsui, Kowloon
Hong Kong
Tel: +862 2737-7200
Fax: +852 2314-0061

National Semiconductor Japan Ltd.
Tel: 81-3-5620-6175
Fax: 81-3-5620-6179

www.fairchildsemi.com

Fairchild does not assume any responsibility for use of any circuitry described, no circuit patent licenses are implied and Fairchild reserves the right at any time without notice to change said circuitry and specifications.