

74VCX162835

Low Voltage 18-Bit Universal Bus Driver with 3.6V Tolerant Inputs/Outputs and 26Ω Series Resistors in Outputs

General Description

The VCX162835 low voltage 18-bit universal bus driver combines D-type latches and D-type flip-flops to allow data flow in transparent, latched and clocked modes.

Data flow is controlled by output-enable (\overline{OE}), latch-enable (LE), and clock (CLK) inputs. The device operates in Transparent Mode when LE is held HIGH. The device operates in clocked mode when LE is LOW and CLK is toggled. Data transfers from the Inputs (I_n) to Outputs (O_n) on a Positive Edge Transition of the Clock. When \overline{OE} is LOW, the output data is enabled. When \overline{OE} is HIGH the output port is in a high impedance state.

The VCX162835 is designed with 26Ω series resistors in the outputs. This design reduces noise in applications such as memory address drivers, clock drivers, and bus transceivers/transmitters.

The 74VCX162835 is designed for low voltage (1.65V to 3.6V) V_{CC} applications with I/O capability up to 3.6V.

The 74VCX162835 is fabricated with an advanced CMOS technology to achieve high speed operation while maintaining low CMOS power dissipation.

Features

- Compatible with PC100 DIMM module specifications
- 1.65V–3.6V V_{CC} specifications provided
- 3.6V tolerant inputs and outputs
- 26Ω series resistors in outputs
- t_{PD} (CP to O_n)
 - 4.2ns max for 3.0V to 3.6V V_{CC}
 - 5.2ns max for 2.3V to 2.7V V_{CC}
 - 9.2ns max for 1.65V to 1.95V V_{CC}
- Power-down high impedance inputs and outputs
- Supports live insertion/withdrawal (Note 1)
- Static Drive (I_{OH}/I_{OL})
 - ±12mA @ 3.0V V_{CC}
 - ±8 mA @ 2.3V V_{CC}
 - ±3 mA @ 1.65V V_{CC}
- Latchup performance exceeds 300 mA
- ESD performance:
 - Human body model > 2000V
 - Machine model >200V

Note 1: To ensure the high impedance state during power up or power down, \overline{OE} should be tied to V_{CC} through a pull-down resistor; the minimum value of the resistor is determined by the current sourcing capability of the driver.

Ordering Code:

Order Number	Package Number	Package Description
74VCX162835MTD	MTD56	56-Lead Thin Shrink Small Outline Package (TSSOP), JEDEC MO-153, 6.1mm Wide

Devices also available in Tape and Reel. Specify by appending the suffix letter "X" to the ordering code.

74VCX162835 Low Voltage 18-Bit Universal Bus Driver with 3.6V Tolerant Inputs/Outputs and 26Ω Series Resistors in Outputs

Connection Diagram

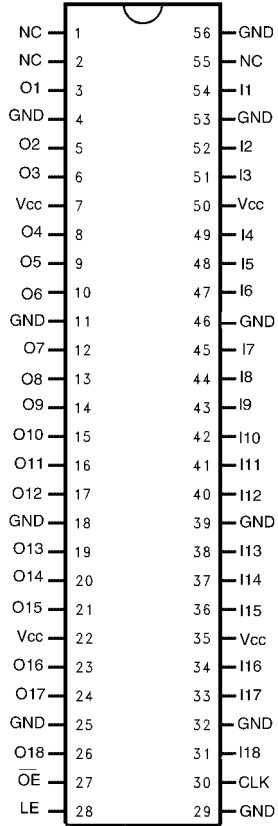

Pin Descriptions

Pin Names	Description
\overline{OE}	Output Enable Input (Active LOW)
LE	Latch Enable Input
CP	Clock Input
$I_1 - I_{18}$	Data Inputs
$O_1 - O_{18}$	3-STATE Outputs

Function Table

Inputs				Outputs
\overline{OE}	LE	CP	I_n	O_n
H	X	X	X	Z
L	H	X	L	L
L	H	X	H	H
L	L	↑	L	L
L	L	↑	H	H
L	L	H	X	O_0 (Note 2)
L	L	L	X	O_0 (Note 3)

H = HIGH Voltage Level
 L = LOW Level Voltage
 X = Immaterial (HIGH or LOW, Inputs may not float)
 Z = High Impedance

Note 2: Output level before the indicated steady-state input conditions were established provided that CP was HIGH before LE went LOW.

Note 3: Output level before the indicated steady-state input conditions were established.

Logic Diagram

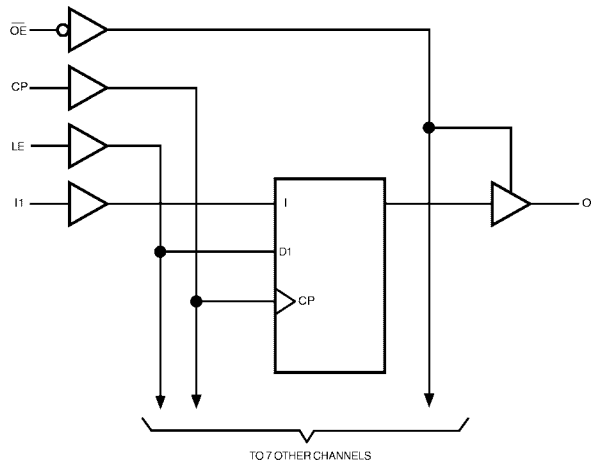

Absolute Maximum Ratings (Note 4)

Supply Voltage (V_{CC})	-0.5V to +4.6V
DC Input Voltage (V_I)	-0.5V to +4.6V
Output Voltage (V_O)	
Outputs 3-STATE	-0.5V to +4.6V
Outputs Active (Note 5)	-0.5 to $V_{CC} + 0.5V$
DC Input Diode Current (I_{IK}) $V_I < 0V$	-50 mA
DC Output Diode Current (I_{OK})	
$V_O < 0V$	-50 mA
$V_O > V_{CC}$	+50 mA
DC Output Source/Sink Current (I_{OH}/I_{OL})	± 50 mA
DC V_{CC} or Ground Current per Supply Pin (I_{CC} or Ground)	± 100 mA
Storage Temperature Range (T_{STG})	-65°C to +150°C

Recommended Operating Conditions (Note 6)

Power Supply	
Operating	1.65V to 3.6V
Data Retention Only	1.2V to 3.6V
Input Voltage	-0.3V to 3.6V
Output Voltage (V_O)	
Output in Active States	0V to V_{CC}
Output in 3-STATE	0.0V to 3.6V
Output Current in I_{OH}/I_{OL}	
$V_{CC} = 3.0V$ to 3.6V	± 12 mA
$V_{CC} = 2.3V$ to 2.7V	± 8 mA
$V_{CC} = 1.65V$ to 2.3V	± 3 mA
Free Air Operating Temperature (T_A)	-40°C to +85°C
Minimum Input Edge Rate ($\Delta t/\Delta V$)	
$V_{IN} = 0.8V$ to 2.0V, $V_{CC} = 3.0V$	10 ns/V

Note 4: The "Absolute Maximum Ratings" are those values beyond which the safety of the device cannot be guaranteed. The device should not be operated at these limits. The parametric values defined in the Electrical Characteristics tables are not guaranteed at the Absolute Maximum Ratings. The Recommended Operating Conditions tables will define the conditions for actual device operation.

Note 5: I_O Absolute Maximum Rating must be observed.

Note 6: Floating or unused pin (inputs or I/O's) must be held HIGH or LOW.

DC Electrical Characteristics (2.7V < $V_{CC} \leq 3.6V$)

Symbol	Parameter	Conditions	V_{CC} (V)	Min	Max	Units
V_{IH}	HIGH Level Input Voltage		2.7-3.6	2.0		V
V_{IL}	LOW Level Input Voltage		2.7-3.6		0.8	V
V_{OH}	HIGH Level Output Voltage	$I_{OH} = -100 \mu A$ $I_{OH} = -6 \text{ mA}$ $I_{OH} = -8 \text{ mA}$ $I_{OH} = -12 \text{ mA}$	2.7-3.6 2.7 3.0 3.0	$V_{CC} - 0.2$ 2.2 2.4 2.2		V
V_{OL}	LOW Level Output Voltage	$I_{OL} = 100 \mu A$ $I_{OL} = 6 \text{ mA}$ $I_{OL} = 8 \text{ mA}$ $I_{OL} = 12 \text{ mA}$	2.7-3.6 2.7 3.0 3.0		0.2 0.4 0.55 0.8	V
I_I	Input Leakage Current	$0V \leq V_I \leq 3.6V$	2.7-3.6		± 5.0	μA
I_{OZ}	3-STATE Output Leakage	$0V \leq V_O \leq 3.6V$ $V_I = V_{IH}$ or V_{IL}	2.7-3.6		± 10	μA
I_{OFF}	Power Off Leakage Current	$0V \leq (V_I, V_O) \leq 3.6V$	0		10	μA
I_{CC}	Quiescent Supply Current	$V_I = V_{CC}$ or GND $V_{CC} \leq (V_I, V_O) \leq 3.6V$ (Note 7)	2.7-3.6 2.7-3.6		20 ± 20	μA
ΔI_{CC}	Increase in I_{CC} per Input	$V_{IH} = V_{CC} - 0.6V$	2.7-3.6		750	μA

Note 7: Outputs disabled or 3-STATE only.

DC Electrical Characteristics ($2.3V \leq V_{CC} \leq 2.7V$)

Symbol	Parameter	Conditions	V _{CC} (V)	Min	Max	Units
V _{IH}	HIGH Level Input Voltage		2.3–2.7	1.6		V
V _{IL}	LOW Level Input Voltage		2.3–2.7		0.7	V
V _{OH}	HIGH Level Output Voltage	I _{OH} = –100 μA I _{OH} = –3 mA I _{OH} = –6 mA I _{OH} = –8 mA	2.3–2.7 2.3 2.3 2.3	V _{CC} – 0.2 2.0 1.8 1.7		V
V _{OL}	LOW Level Output Voltage	I _{OL} = 100 μA I _{OL} = 6 mA I _{OL} = 8 mA	2.3–2.7 2.3 2.3		0.2 0.4 0.6	V
I _I	Input Leakage Current	0 ≤ V _I ≤ 3.6V	2.3–2.7		±5.0	μA
I _{OZ}	3-STATE Output Leakage	0 ≤ V _O ≤ 3.6V V _I = V _{IH} or V _{IL}	2.3–2.7		±10	μA
I _{OFF}	Power Off Leakage Current	0 ≤ (V _I , V _O) ≤ 3.6V	0		10	μA
I _{CC}	Quiescent Supply Current	V _I = V _{CC} or GND V _{CC} ≤ (V _I , V _O) ≤ 3.6V (Note 8)	2.3–2.7 2.3–2.7		20 ±20	μA

Note 8: Outputs disabled or 3-STATE only.

DC Electrical Characteristics ($1.65V \leq V_{CC} < 2.3V$)

Symbol	Parameter	Conditions	V _{CC} (V)	Min	Max	Units
V _{IH}	HIGH Level Input Voltage		1.65 - 2.3	0.65 × V _{CC}		V
V _{IL}	LOW Level Input Voltage		1.65 - 2.3		0.35 × V _{CC}	V
V _{OH}	HIGH Level Output Voltage	I _{OH} = –100 μA I _{OH} = –3 mA	1.65 - 2.3 1.65	V _{CC} – 0.2 1.25		V
V _{OL}	LOW Level Output Voltage	I _{OL} = 100 μA I _{OL} = 3 mA	1.65 - 2.3 1.65		0.2 0.3	V
I _I	Input Leakage Current	0 ≤ V _I ≤ 3.6V	1.65 - 2.3		±5.0	μA
I _{OZ}	3-STATE Output Leakage	0 ≤ V _O ≤ 3.6V V _I = V _{IH} or V _{IL}	1.65 - 2.3		±10	μA
I _{OFF}	Power Off Leakage Current	0 ≤ (V _I , V _O) ≤ 3.6V	0		10	μA
I _{CC}	Quiescent Supply Current	V _I = V _{CC} or GND V _{CC} ≤ (V _I , V _O) ≤ 3.6V (Note 9)	1.65 - 2.3 1.65 - 2.3		20 ±20	μA

Note 9: Outputs disabled or 3-STATE only.

AC Electrical Characteristics (Note 10)								
Symbol	Parameter	$T_A = -40^{\circ}\text{C to } +85^{\circ}\text{C}, C_L = 30\text{ pF}, R_L = 500\Omega$						Units
		$V_{CC} = 3.3\text{V} \pm 0.3\text{V}$		$V_{CC} = 2.5 \pm 0.2\text{V}$		$V_{CC} = 1.8 \pm 0.15\text{V}$		
		Min	Max	Min	Max	Min	Max	
f_{MAX}	Maximum Clock Frequency	250		200		100		MHz
t_{PHL}, t_{PLH}	Propagation Delay Bus to Bus	0.6	3.9	0.8	5.0	1.5	9.8	ns
t_{PHL}, t_{PLH}	Propagation Delay Clock to Bus	1.4	4.2	1.5	5.2	2.0	9.2	ns
t_{PHL}, t_{PLH}	Propagation Delay LE to Bus	0.6	4.7	0.8	5.8	1.5	9.8	ns
t_{PZL}, t_{PZH}	Output Enable Time	0.6	4.3	0.8	5.9	1.5	9.8	ns
t_{PLZ}, t_{PHZ}	Output Disable Time	0.6	4.2	0.8	4.7	1.5	7.9	ns
t_S	Setup Time	1.5		1.5		2.5		ns
t_H	Hold Time	0.7		0.7		1.0		ns
t_W	Pulse Width	1.5		1.5		4.0		ns
t_{OSHL} t_{OSLH}	Output to Output Skew (Note 11)		0.5		0.5		0.75	ns
<p>Note 10: For $C_L=50\text{pF}$, add approximately 300ps to the AC maximum specification.</p> <p>Note 11: Skew is defined as the absolute value of the difference between the actual propagation delay for any two separate outputs of the same device. The specification applies to any outputs switching in the same direction, either HIGH-to-LOW (t_{OSHL}) or LOW-to-HIGH (t_{OSLH}).</p>								
AC Electrical Characteristics Over Load (Note 12)								
Symbol	Parameter	$T_A = -0^{\circ}\text{C to } +85^{\circ}\text{C}, R_L = 500\Omega, V_{CC} = 3.3\text{V} \pm 0.15\text{V}$				Units		
		$C_L = 0\text{ pF}$		$C_L = 50\text{ pF}$				
		Min	Max	Min	Max			
t_{PHL}, t_{PLH}	Prop Delay Bus to Bus	0.7	2.6	1.0	4.2	ns		
t_{PHL}, t_{PLH}	Prop Delay Clock to Bus	1.4	2.9	1.9	4.5	ns		
t_{PHL}, t_{PLH}	Prop Delay LE to Bus	0.7	3.4	1.0	5.0	ns		
t_{PZL}, t_{PZH}	Output Enable Time	0.7	3.0	1.0	4.6	ns		
t_{PLZ}, t_{PHZ}	Output Disable Time	0.7	2.9	1.0	4.5	ns		
t_{PHL}, t_{PLH}	SSO Prop Delay Clock to Bus (Note 13)	1.4	3.2			ns		
t_S	Setup Time	1.5		1.5		ns		
t_H	Hold Time	0.7		0.7		ns		
<p>Note 12: Characterized only.</p> <p>Note 13: SSO=Simultaneous Switching Output. Any output combination of LOW-to-HIGH and/or HIGH-to-LOW transition.</p>								
Dynamic Switching Characteristics								
Symbol	Parameter	Conditions	V_{CC} (V)	$T_A = +25^{\circ}\text{C}$	Units			
				Typical				
V_{OLP}	Quiet Output Dynamic Peak V_{OL}	$C_L = 30\text{ pF}, V_{IH} = V_{CC}, V_{IL} = 0\text{V}$	1.8 2.5 3.3	0.25 0.35 0.45	V			
V_{OLV}	Quiet Output Dynamic Valley V_{OL}	$C_L = 30\text{ pF}, V_{IH} = V_{CC}, V_{IL} = 0\text{V}$	1.8 2.5 3.3	-0.25 -0.35 -0.45	V			
V_{OHV}	Quiet Output Dynamic Valley V_{OH}	$C_L = 30\text{ pF}, V_{IH} = V_{CC}, V_{IL} = 0\text{V}$	1.8 2.5 3.3	1.35 1.85 2.45	V			

Capacitance

Symbol	Parameter	Conditions	$T_A = +25^\circ\text{C}$		Units
			Typical		
C_{IN}	Input Capacitance	$V_I = 0\text{V or } V_{CC}, V_{CC} = 1.8\text{V, } 2.5\text{V, or } 3.3\text{V,}$	3.5		pF
$C_{I/O}$	Input/Output Capacitance	$V_I = 0\text{V, or } V_{CC}, V_{CC} = 1.8\text{V, } 2.5\text{V or } 3.3\text{V}$	5.5		pF
C_{PD}	Power Dissipation Capacitance	$V_I = 0\text{V or } V_{CC}, f = 10\text{ MHz, } V_{CC} = 1.8\text{V, } 2.5\text{V or } 3.3\text{V}$	13		pF

$I_{OUT} - V_{OUT}$ Characteristics

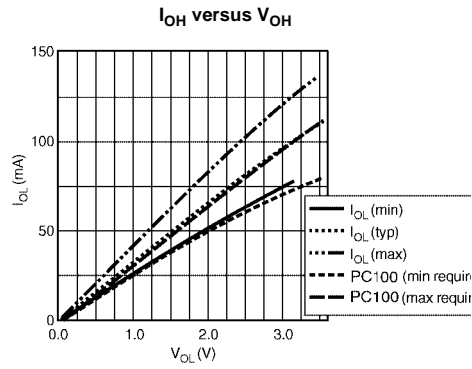

FIGURE 1. Characteristics for Output - Pull Up Drive

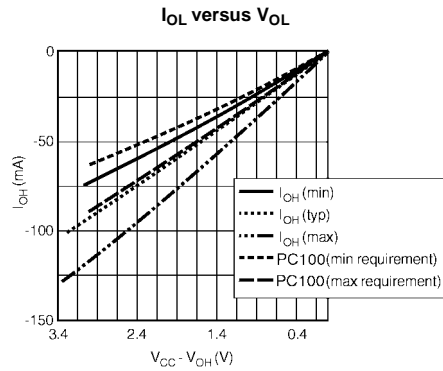

FIGURE 2. Characteristics for Output - Pull Down Driver

AC Loading and Waveforms

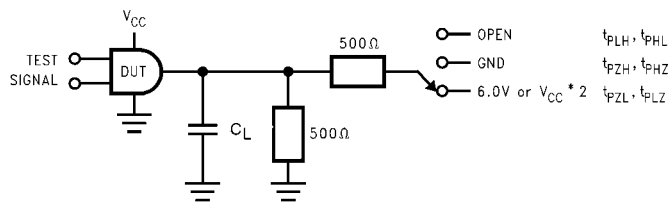

FIGURE 3. AC Test Circuit

TEST	SWITCH
t_{PLH}, t_{PHL}	Open
t_{PZL}, t_{PLZ}	6V at $V_{CC} = 3.3 \pm 0.3V$; $V_{CC} \times 2$ at $V_{CC} = 2.5 \pm 0.2V$; $1.8V$ to $\pm 0.15V$
t_{PZH}, t_{PHZ}	GND

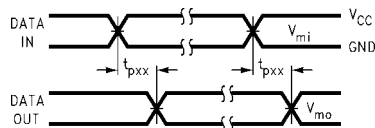

FIGURE 4. Waveform for Inverting and Non-inverting Functions
 $t_r = t_f \leq 2.0ns$, 10% to 90%

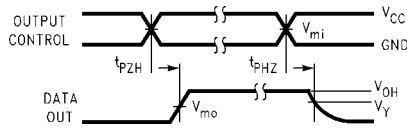

FIGURE 5. 3-STATE Output High Enable and Disable Times for Low Voltage Logic
 $t_r = t_f \leq 2.0ns$, 10% to 90%

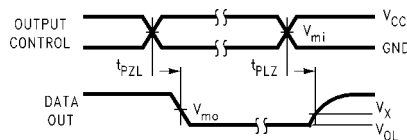
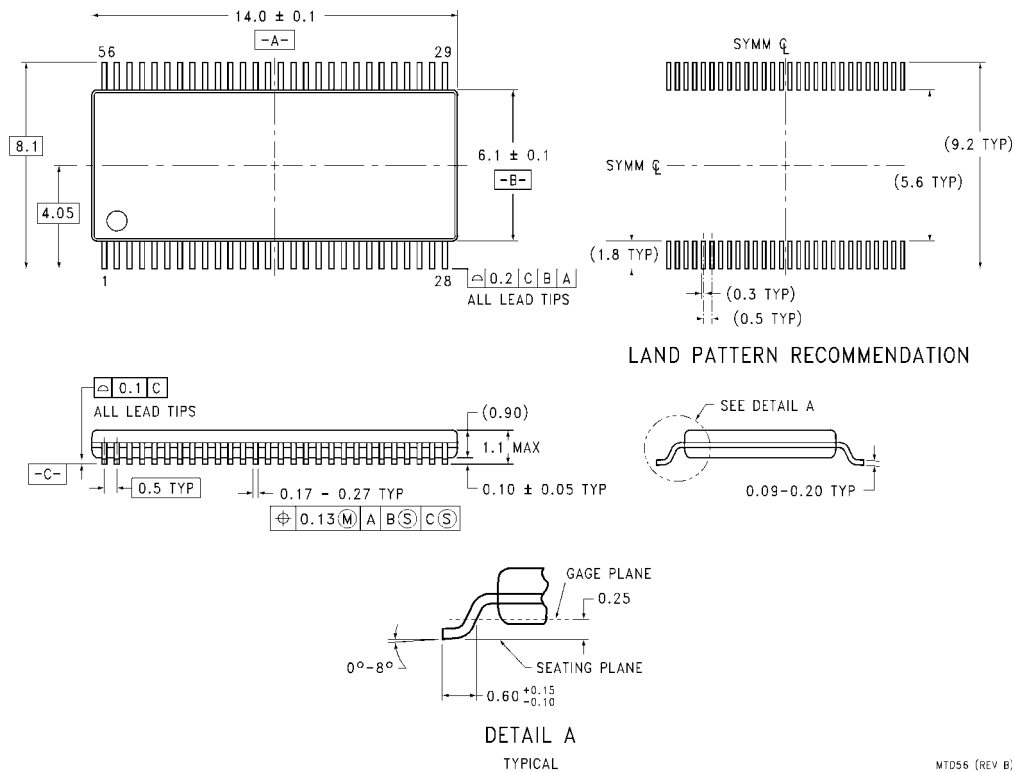

FIGURE 6. 3-STATE Output Low Enable and Disable Times for Low Voltage Logic
 $t_r = t_f \leq 2.0ns$, 10% to 90%

Symbol	V_{CC}		
	$3.3V \pm 0.3V$	$2.5V \pm 0.2V$	$1.8 \pm 0.15V$
V_{mi}	1.5V	$V_{CC}/2$	$V_{CC}/2$
V_{mo}	1.5V	$V_{CC}/2$	$V_{CC}/2$
V_x	$V_{OL} + 0.3V$	$V_{OL} + 0.15V$	$V_{OL} + 0.15V$
V_y	$V_{OH} - 0.3V$	$V_{OH} - 0.15V$	$V_{OH} - 0.15V$

Physical Dimensions inches (millimeters) unless otherwise noted



56-Lead Thin Shrink Small Outline Package (TSSOP), JEDEC MO-153, 6.1mm Wide Package Number MTD56

Fairchild does not assume any responsibility for use of any circuitry described, no circuit patent licenses are implied and Fairchild reserves the right at any time without notice to change said circuitry and specifications.

LIFE SUPPORT POLICY

FAIRCHILD'S PRODUCTS ARE NOT AUTHORIZED FOR USE AS CRITICAL COMPONENTS IN LIFE SUPPORT DEVICES OR SYSTEMS WITHOUT THE EXPRESS WRITTEN APPROVAL OF THE PRESIDENT OF FAIRCHILD SEMICONDUCTOR CORPORATION. As used herein:

1. Life support devices or systems are devices or systems which, (a) are intended for surgical implant into the body, or (b) support or sustain life, and (c) whose failure to perform when properly used in accordance with instructions for use provided in the labeling, can be reasonably expected to result in a significant injury to the user.
2. A critical component in any component of a life support device or system whose failure to perform can be reasonably expected to cause the failure of the life support device or system, or to affect its safety or effectiveness.

www.fairchildsemi.com