

## 74VHC4316 Quad Analog Switch with Level Translator

### General Description

These devices are digitally controlled analog switches implemented in advanced silicon-gate CMOS technology. These switches have low "on" resistance and low "off" leakages. They are bidirectional switches, thus any analog input may be used as an output and vice-versa. Three supply pins are provided on the 4316 to implement a level translator which enables this circuit to operate with 0V–6V logic levels and up to ±6V analog switch levels. The 4316 also has a common enable input in addition to each switch's control which when HIGH will disable all switches to their off state. All analog inputs and outputs and digital

inputs are protected from electrostatic damage by diodes to  $V_{CC}$  and ground.

### Features

- Typical switch enable time: 20 ns
- Wide analog input voltage range: ±6V
- Low "on" resistance: 50 typ. ( $V_{CC}-V_{EE} = 4.5V$ )  
30 typ. ( $V_{CC}-V_{EE} = 9V$ )
- Low quiescent current: 80  $\mu A$  maximum (74VHC)
- Matched switch characteristics
- Individual switch controls plus a common enable
- Pin functional compatible with 74HC4316

### Ordering Code:

| Order Number | Package Number | Package Description   |
|--------------|----------------|---|
| 74VHC4316M   | M16A           | 16-Lead Small Outline Integrated Circuit (SOIC), JEDEC MS-012, 0.150 Narrow |
| 74VHC4316WM  | M16B           | 16-Lead Small Outline Integrated Circuit (SOIC), JEDEC MS-013, 0.300 Wide   |
| 74VHC4316MTC | MTC16          | 16-Lead Thin Shrink Small Outline Package (TSSOP), JEDEC MO-153, 4.4mm Wide |
| 74VHC4316N   | N16E           | 16-Lead Plastic Dual-In-Line Package (PDIP), JEDEC MS-001, 0.300 Wide       |

Surface mount packages are also available on Tape and Reel. Specify by appending the suffix letter "X" to the ordering code.

### Truth Table

| Inputs    |     | Switch  |
|-----------|-----|---------|
| $\bar{E}$ | CTL | I/O–O/I |
| H         | X   | "OFF"   |
| L         | L   | "OFF"   |
| L         | H   | "ON"    |

### Connection Diagram

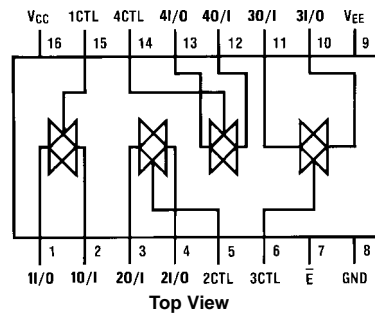

### Logic Diagram

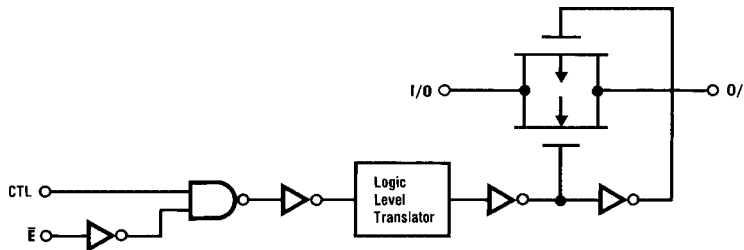

**Absolute Maximum Ratings** (Note 1)

(Note 2)

|  |                               |
|--|-------------------------------|
| Supply Voltage ( $V_{CC}$ )                      | -0.5 to +7.5V                 |
| Supply Voltage ( $V_{EE}$ )                      | +0.5 to -7.5V                 |
| DC Control Input Voltage ( $V_{IN}$ )            | -1.5 to $V_{CC}+1.5V$         |
| DC Switch I/O Voltage ( $V_{IO}$ )               | $V_{EE}-0.5$ to $V_{CC}+0.5V$ |
| Clamp Diode Current ( $I_{IK}, I_{OK}$ )         | $\pm 20$ mA                   |
| DC Output Current, per pin ( $I_{OUT}$ )         | $\pm 25$ mA                   |
| DC $V_{CC}$ or GND Current, per pin ( $I_{CC}$ ) | $\pm 50$ mA                   |
| Storage Temperature Range ( $T_{STG}$ )          | -65°C to +150°C               |
| Power Dissipation ( $P_D$ ) (Note 3)             | 600 mW                        |
| S.O. Package only                                | 500 mW                        |
| Lead Temperature ( $T_L$ )                       |                               |
| (Soldering 10 seconds)                           | 260°C                         |

**Recommended Operating Conditions**

|  | Min | Max      | Units |
|--|-----|----------|-------|
| Supply Voltage ( $V_{CC}$ )                      | 2   | 6        | V     |
| Supply Voltage ( $V_{EE}$ )                      | 0   | -6       | V     |
| DC Input or Output Voltage ( $V_{IN}, V_{OUT}$ ) | 0   | $V_{CC}$ | V     |
| Operating Temperature Range ( $T_A$ )            | -40 | +85      | °C    |
| Input Rise or Fall Times ( $t_r, t_f$ )          |     |          |       |
| $V_{CC} = 2.0V$                                  |     | 1000     | ns    |
| $V_{CC} = 4.5V$                                  |     | 500      | ns    |
| $V_{CC} = 6.0V$                                  |     | 400      | ns    |
| $V_{CC} = 12.0V$                                 |     | 250      | ns    |

**Note 1:** Absolute Maximum Ratings are those values beyond which damage to the device may occur.

**Note 2:** Unless otherwise specified all voltages are referenced to ground.

**Note 3:** Power Dissipation temperature derating — plastic "N" package: — 12 mW/°C from 65°C to 85°C.

**DC Electrical Characteristics** (Note 4)

| Symbol   | Parameter                            | Conditions   | $V_{EE}$ | $V_{CC}$ | $T_A = 25^\circ\text{C}$ |                   | $T_A = -40^\circ\text{C to } +85^\circ\text{C}$ |               | Units |
|----------|--------------------------------------|--|----------|----------|--------------------------|-------------------|---|---------------|-------|
|          |                                      |  |          |          | Typ                      | Guaranteed Limits |   |               |       |
| $V_{IH}$ | Minimum HIGH Level Input Voltage     |  |          | 2.0V     |                          | 1.5               | 1.5   | V             |       |
|          |                                      |  |          | 4.5V     |                          | 3.15              | 3.15  |               |       |
|          |                                      |  |          | 6.0V     |                          | 4.2               | 4.2   |               |       |
| $V_{IL}$ | Maximum LOW Level Input Voltage      |  |          | 2.0V     |                          | 0.5               | 0.5   | V             |       |
|          |                                      |  |          | 4.5V     |                          | 1.35              | 1.35  |               |       |
|          |                                      |  |          | 6.0V     |                          | 1.8               | 1.8   |               |       |
| $R_{ON}$ | Minimum "ON" Resistance (Note 5)     | $V_{CTL} = V_{IH}$ ,<br>$I_S = 2.0$ mA<br>$V_{IS} = V_{CC}$ to $V_{EE}$<br>(Figure 1)              | GND      | 4.5V     | 100                      | 170               | 200   | $\Omega$      |       |
|          |                                      |  | -4.5V    | 4.5V     | 40                       | 85                | 105   |               |       |
|          |                                      |  | -6.0V    | 6.0V     | 30                       | 70                | 85  |               |       |
|          |                                      | GND  | 2.0V     | 100      | 180                      | 215               |   |               |       |
|          |                                      | GND  | 4.5V     | 40       | 80                       | 100               |   |               |       |
|          |                                      | -4.5V  | 4.5V     | 50       | 60                       | 75                |   |               |       |
| $R_{ON}$ | Maximum "ON" Resistance Matching     | $V_{CTL} = V_{IH}$ ,<br>$V_{IS} = V_{CC}$ to $V_{EE}$<br>(Figure 1)                                | GND      | 4.5V     | 10                       | 15                | 20  | $\Omega$      |       |
|          |                                      |  | -4.5V    | 4.5V     | 5                        | 10                | 15  |               |       |
|          |                                      |  | -6.0V    | 6.0V     | 5                        | 10                | 15  |               |       |
| $I_{IN}$ | Maximum Control Input Current        | $V_{IN} = V_{CC}$ or GND   | GND      | 6.0V     |                          | $\pm 0.1$         | $\pm 1.0$                                       | $\mu\text{A}$ |       |
| $I_{IZ}$ | Maximum Switch "OFF" Leakage Current | $V_{OS} = V_{CC}$ or $V_{EE}$<br>$V_{IS} = V_{EE}$ or $V_{CC}$<br>$V_{CTL} = V_{IL}$<br>(Figure 2) | GND      | 6.0V     |                          | $\pm 30$          | $\pm 300$                                       | nA            |       |
|          |                                      |  | -6.0V    | 6.0V     |                          | $\pm 50$          | $\pm 500$                                       |               |       |
| $I_{IZ}$ | Maximum Switch "ON" Leakage Current  | $V_{IS} = V_{CC}$ to $V_{EE}$<br>$V_{CTL} = V_{IH}$ ,<br>$V_{OS} = \text{OPEN}$<br>(Figure 3)      | GND      | 6.0V     |                          | $\pm 20$          | $\pm 75$  | nA            |       |
|          |                                      |  | -6.0V    | 6.0V     |                          | $\pm 30$          | $\pm 150$                                       |               |       |
| $I_{CC}$ | Maximum Quiescent Supply Current     | $V_{IN} = V_{CC}$ or GND<br>$I_{OUT} = 0$ $\mu\text{A}$  | GND      | 6.0V     |                          | 1.0               | 10  | $\mu\text{A}$ |       |
|          |                                      |  | -6.0V    | 6.0V     |                          | 4.0               | 40  |               |       |

**Note 4:** For a power supply of 5V  $\pm 10\%$  the worst case on resistances ( $R_{ON}$ ) occurs for VHC at 4.5V. Thus the 4.5V values should be used when designing with this supply. Worst case  $V_{IH}$  and  $V_{IL}$  occur at  $V_{CC} = 5.5V$  and 4.5V respectively. (The  $V_{IH}$  value at 5.5V is 3.85V.) The worst case leakage current occurs for CMOS at the higher voltage and so the 5.5V values should be used.

**Note 5:** At supply voltages ( $V_{CC}-V_{EE}$ ) approaching 2V the analog switch on resistance becomes extremely non-linear. Therefore it is recommended that these devices be used to transmit digital only when using these supply voltages.

| AC Electrical Characteristics   |   |   |                 |                 |                        |                   |                                 |       |
|---|---|---|-----------------|-----------------|------------------------|-------------------|---------------------------------|-------|
| V <sub>CC</sub> = 2.0V – 6.0V, V <sub>EE</sub> = 0V – 6V, C <sub>L</sub> = 50 pF unless otherwise specified   |   |   |                 |                 |                        |                   |                                 |       |
| Symbol  | Parameter   | Conditions  | V <sub>EE</sub> | V <sub>CC</sub> | T <sub>A</sub> = +25°C |                   | T <sub>A</sub> = –40°C to +85°C | Units |
|   |   |   |                 |                 | Typ                    | Guaranteed Limits |                                 |       |
| t <sub>PHL</sub> , t <sub>PLH</sub>   | Maximum Propagation Delay Switch In to Out          |   | GND             | 3.3V            | 15                     | 30                | 37                              | ns    |
|   |   |   | GND             | 4.5V            | 5                      | 10                | 13                              |       |
|   |   |   | –4.5V           | 4.5V            | 4                      | 8                 | 12                              |       |
|   |   |   | –6.0V           | 6.0V            | 3                      | 7                 | 11                              |       |
| t <sub>PZL</sub> , t <sub>PZH</sub>   | Maximum Switch Turn "ON" Delay (Control)            | R <sub>L</sub> = 1 kΩ   | GND             | 3.3V            | 25                     | 97                | 120                             | ns    |
|   |   |   | GND             | 4.5V            | 20                     | 35                | 43                              |       |
|   |   |   | –4.5V           | 4.5V            | 15                     | 32                | 39                              |       |
|   |   |   | –6.0V           | 6.0V            | 14                     | 30                | 37                              |       |
| t <sub>PHZ</sub> , t <sub>PLZ</sub>   | Maximum Switch Turn "OFF" Delay (Control)           | R <sub>L</sub> = 1 kΩ   | GND             | 3.3V            | 35                     | 145               | 180                             | ns    |
|   |   |   | GND             | 4.5V            | 25                     | 50                | 63                              |       |
|   |   |   | –4.5V           | 4.5V            | 20                     | 44                | 55                              |       |
|   |   |   | –6.0V           | 6.0V            | 20                     | 44                | 55                              |       |
| t <sub>PZL</sub> , t <sub>PZH</sub>   | Maximum Switch Turn "ON" Delay (Enable)             |   | GND             | 3.3V            | 27                     | 120               | 150                             | ns    |
|   |   |   | GND             | 4.5V            | 20                     | 41                | 52                              |       |
|   |   |   | –4.5V           | 4.5V            | 19                     | 38                | 48                              |       |
|   |   |   | –6.0V           | 6.0V            | 18                     | 36                | 45                              |       |
| t <sub>PLZ</sub> , t <sub>PHZ</sub>   | Maximum Switch Turn "OFF" Delay (Enable)            |   | GND             | 3.3V            | 42                     | 155               | 190                             | ns    |
|   |   |   | GND             | 4.5V            | 28                     | 53                | 67                              |       |
|   |   |   | –4.5V           | 4.5V            | 23                     | 47                | 59                              |       |
|   |   |   | –6.0V           | 6.0V            | 21                     | 47                | 59                              |       |
|   | Minimum Frequency Response (Figure 7)               | R <sub>L</sub> = 600Ω, V <sub>IS</sub> = 2V <sub>PP</sub> at (V <sub>CC</sub> –V <sub>EE</sub> /2) (Note 6)(Note 7) | 0V              | 4.5             | 40                     |                   |                                 | MHz   |
|   | Control to Switch Feedthrough Noise (Figure 8)      | R <sub>L</sub> = 600Ω, f = 1 MHz<br>C <sub>L</sub> = 50 pF (Note 7)(Note 8)   | 0V              | 4.5V            | 100                    |                   |                                 | mV    |
|   | Crosstalk Between any Two Switches (Figure 9)       | R <sub>L</sub> = 600Ω, f = 1 MHz  | 0V              | 4.5V            | –52                    |                   |                                 | dB    |
|   | Switch OFF Signal Feedthrough Isolation (Figure 10) | R <sub>L</sub> = 600Ω, f = 1 MHz<br>V <sub>CTL</sub> = V <sub>IL</sub> (Note 7)(Note 8)                             | 0V              | 4.5V            | –42                    |                   |                                 | dB    |
|   | THD   | R <sub>L</sub> = 10 KΩ, C <sub>L</sub> = 50 pF, f = 1 KHz   |                 |                 |                        |                   |                                 | %     |
|   |   | V <sub>IS</sub> = 4 V <sub>PP</sub>   | 0V              | 4.5V            | 0.013                  |                   |                                 |       |
|   |   | V <sub>IS</sub> = 8 V <sub>PP</sub>   | –4.5V           | 4.5V            | 0.008                  |                   |                                 |       |
| C <sub>IN</sub>   | Maximum Control Input Capacitance                   |   |                 |                 | 5                      |                   |                                 | pF    |
| C <sub>IN</sub>   | Maximum Switch Input Capacitance                    |   |                 |                 | 35                     |                   |                                 | pF    |
| C <sub>IN</sub>   | Maximum Feedthrough Capacitance                     | V <sub>CTL</sub> = GND  |                 |                 | 0.5                    |                   |                                 | pF    |
| C <sub>PD</sub>   | Power Dissipation Capacitance                       |   |                 |                 | 15                     |                   |                                 | pF    |
| <p><b>Note 6:</b> Adjust 0 dBm for f = 1 kHz (Null R<sub>L</sub>/Ron Attenuation).</p> <p><b>Note 7:</b> V<sub>IS</sub> is centered at V<sub>CC</sub>–V<sub>EE</sub>/2.</p> <p><b>Note 8:</b> Adjust for 0 dBm.</p> |   |   |                 |                 |                        |                   |                                 |       |

AC Test Circuits and Switching Time Waveforms

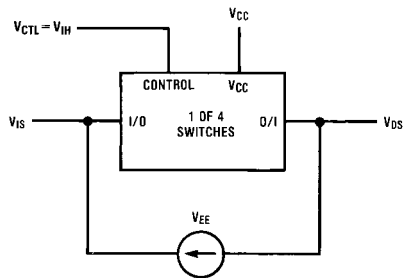

FIGURE 1. "ON" Resistance

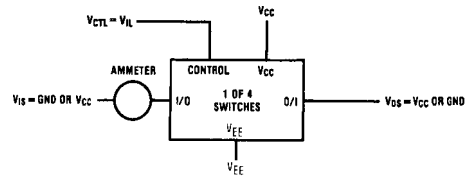

FIGURE 2. "OFF" Channel Leakage Current

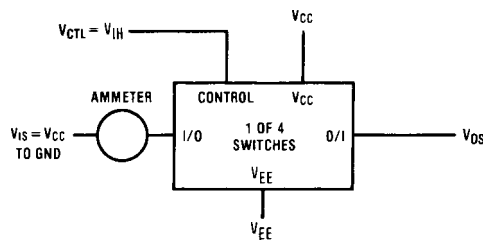

FIGURE 3. "ON" Channel Leakage Current

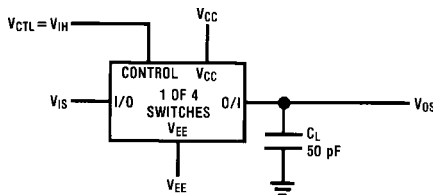

FIGURE 4.  $t_{pHL}$ ,  $t_{pLH}$  Propagation Delay Time Signal Input to Signal Output

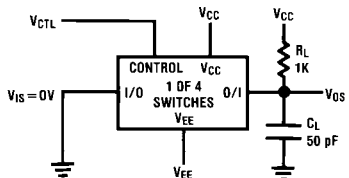
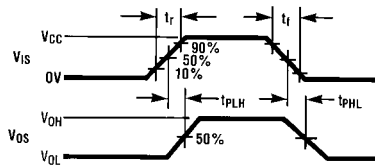

FIGURE 5.  $t_{pZL}$ ,  $t_{pLZ}$  Propagation Delay Time Control to Signal Output

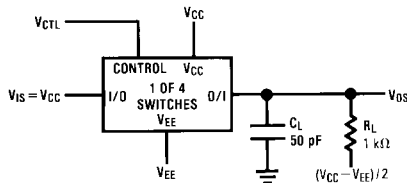
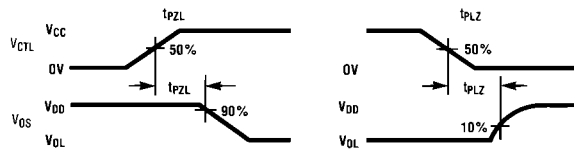
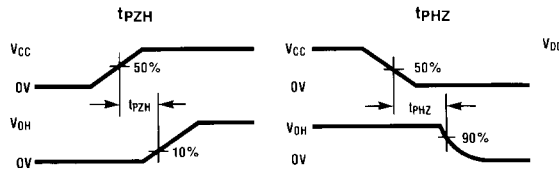

FIGURE 6.  $t_{pZH}$ ,  $t_{pHZ}$  Propagation Delay Time Control to Signal Output



AC Test Circuits and Switching Time Waveforms (Continued)

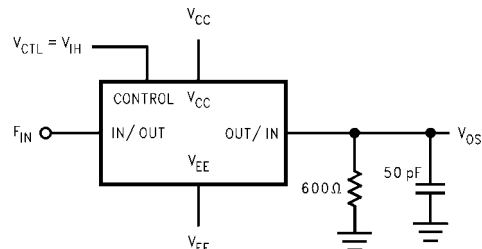

FIGURE 7. Frequency Response

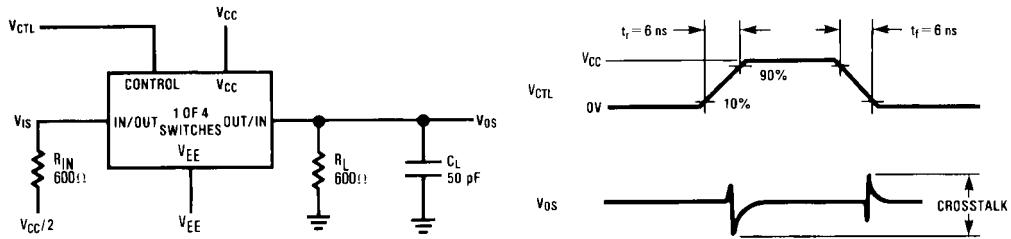

FIGURE 8. Crosstalk: Control Input to Signal Output

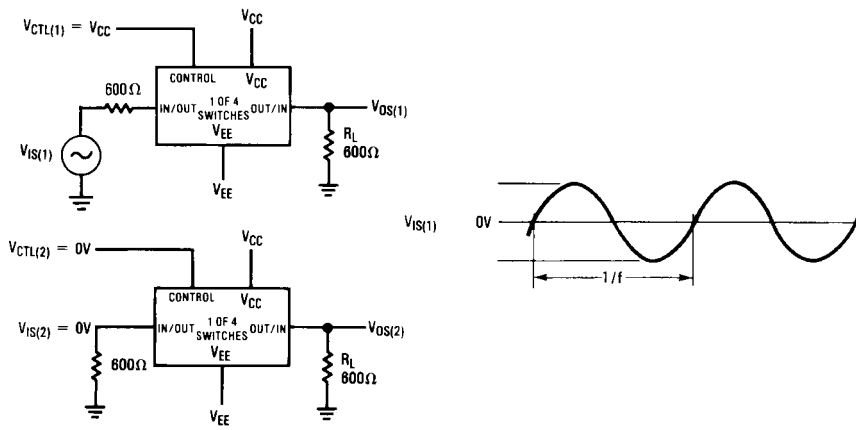

FIGURE 9. Crosstalk between Any Two Switches

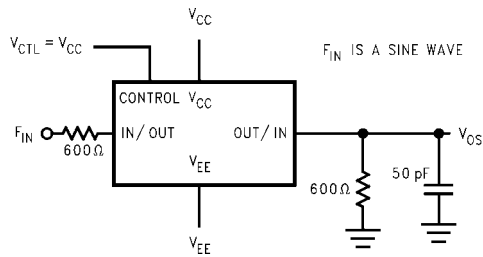

FIGURE 10. Switch OFF Signal Feedthrough Isolation

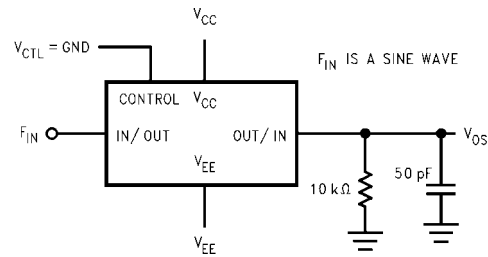
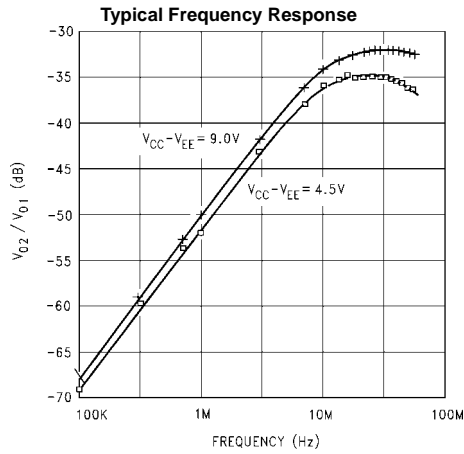
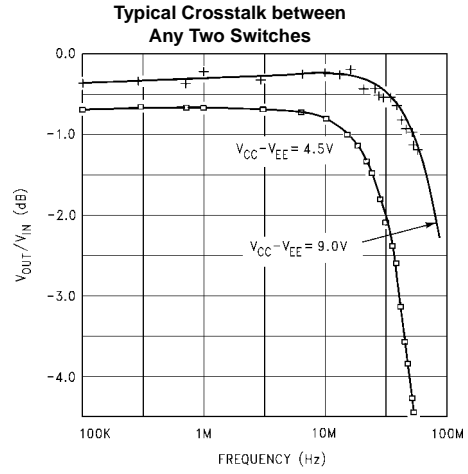
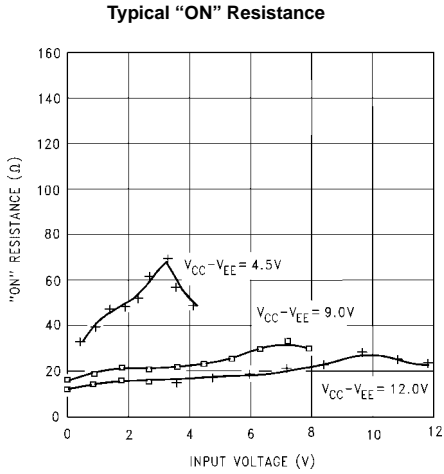

FIGURE 11. Sinewave Distortion

Typical Performance Characteristics



Special Considerations

In certain applications the external load-resistor current may include both  $V_{CC}$  and signal line components. To avoid drawing  $V_{CC}$  current when switch current flows into the analog switch input pins, the voltage drop across the switch must not exceed 0.6V (calculated from the ON resistance).

**Physical Dimensions** inches (millimeters) unless otherwise noted

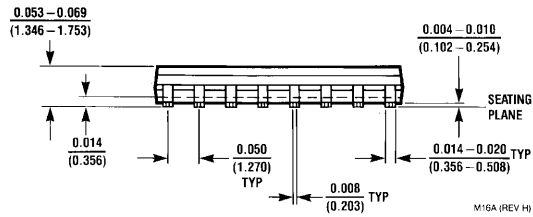
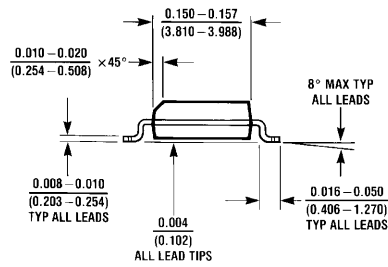
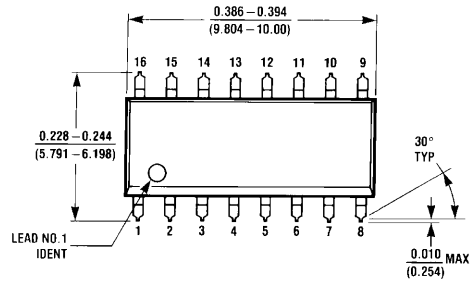

**16-Lead Small Outline Integrated Circuit (SOIC), JEDEC MS-012, 0.150 Narrow Package Number M16A**

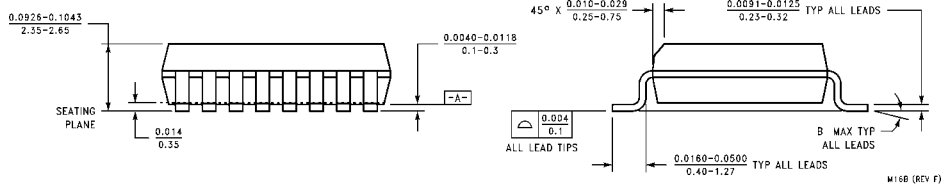
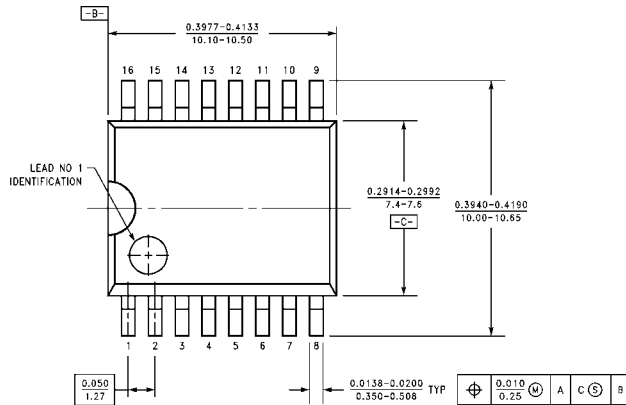

**16-Lead Small Outline Integrated Circuit (SOIC), JEDEC MS-013, 0.300 Wide Package Number M16B**

**Physical Dimensions** inches (millimeters) unless otherwise noted (Continued)

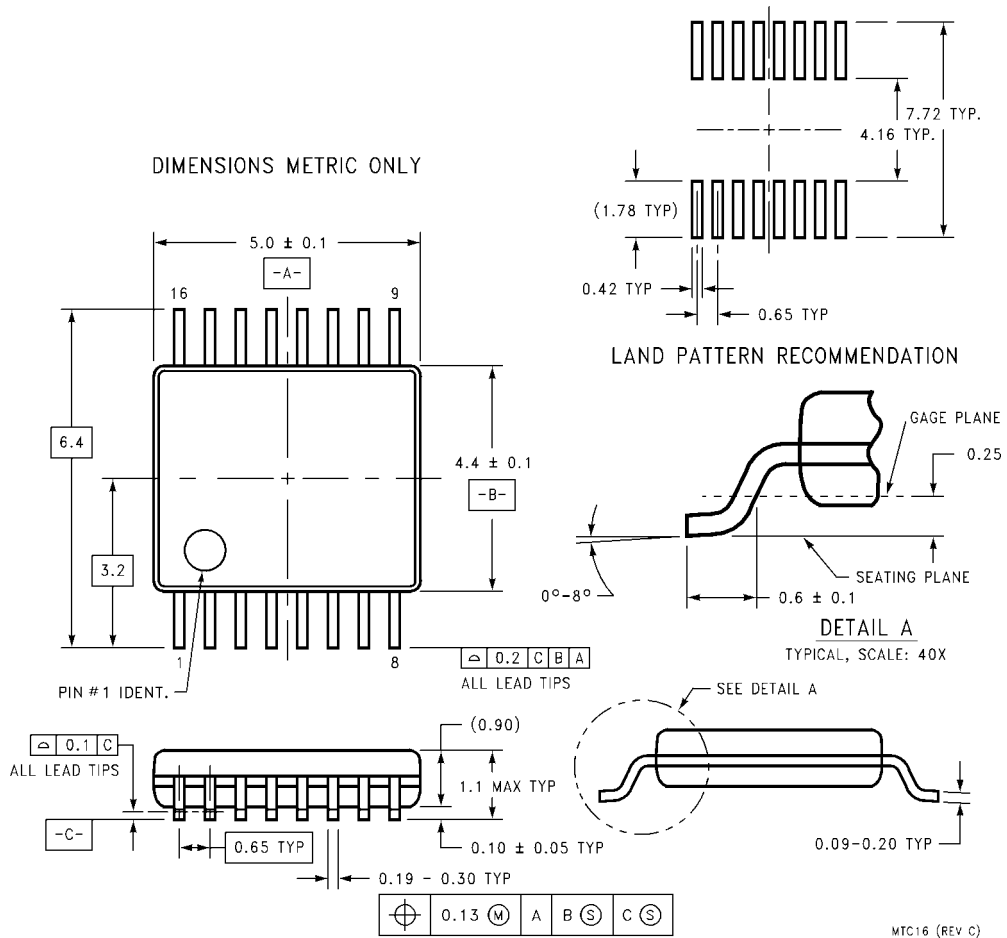

**16-Lead Thin Shrink Small Outline Package (TSSOP), JEDEC MO-153, 4.4mm Wide  
Package Number MTC16**

MTC16 (REV C)



**Physical Dimensions** inches (millimeters) unless otherwise noted (Continued)

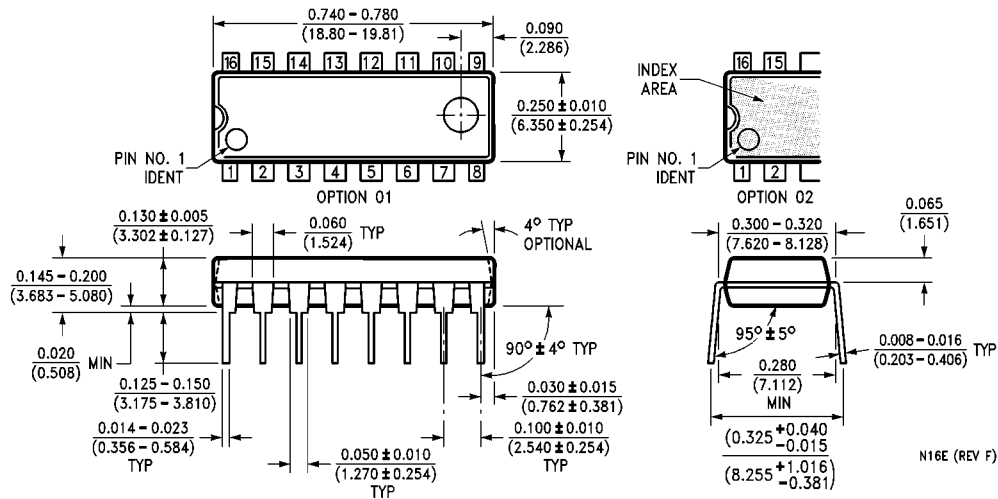

**16-Lead Plastic Dual-In-Line Package (PDIP), JEDEC MS-001, 0.300 Wide Package Number N16E**

**LIFE SUPPORT POLICY**

FAIRCHILD'S PRODUCTS ARE NOT AUTHORIZED FOR USE AS CRITICAL COMPONENTS IN LIFE SUPPORT DEVICES OR SYSTEMS WITHOUT THE EXPRESS WRITTEN APPROVAL OF THE PRESIDENT OF FAIRCHILD SEMICONDUCTOR CORPORATION. As used herein:

1. Life support devices or systems are devices or systems which, (a) are intended for surgical implant into the body, or (b) support or sustain life, and (c) whose failure to perform when properly used in accordance with instructions for use provided in the labeling, can be reasonably expected to result in a significant injury to the user.
2. A critical component in any component of a life support device or system whose failure to perform can be reasonably expected to cause the failure of the life support device or system, or to affect its safety or effectiveness.

[www.fairchildsemi.com](http://www.fairchildsemi.com)