

78 Series Electromechanical Relay Selection Guide



Specification	781 Series	782 Series	783 Series	784 Series
Coil Voltages	120VAC, 240VAC, 12VAC, 12VDC, 24VAC, 24VDC	120VAC, 240VAC, 12VAC, 12VDC, 24VAC, 24VDC	120VAC, 240VAC, 12VAC, 12VDC, 24VAC, 24VDC	120VAC, 240VAC, 12VAC, 12VDC, 24VAC, 24VDC
Configuration	SPDT	DPDT	3PDT	4PDT
Contact Rating	15A	15A	15A	15A
Base Socket	5 pin spade terminal	8 pin spade terminal	11 pin spade terminal	14 pin spade terminal
Agency Approvals	UL Recognized (E191059), CE, IEC Std 947-4-1 and 947-5-1, CSA 244610	UL Recognized (E191059), CE, IEC Std 947-4-1 and 947-5-1, CSA 244610	UL Recognized (E191059), CE, IEC Std 947-4-1 and 947-5-1, CSA 244610	UL Recognized (E191059), CE, CSA 244610
Prices starting at	\$4.50	\$5.50	\$5.75	\$7.25



These ice cube style relays are power relays designed for applications demanding high power control in various factory machines and control panels. They are ideal for electrical control panels requiring stable and reliable relays.

Features

- Small package design
- Silver alloy gold flashed contact
- High open contact dielectric strength (up to 2500V rms)
- High reliability and long life
- High vibration and shock resistance
- LED indicator on all models, so you can easily see if the relay is working properly without using a voltmeter
- Flag indicator shows relay status in manual or powered condition
- A pushbutton allows manual operation of the relay without the need for power to the coil
- Lock-Down door, when activated, holds pushbutton and contacts in the “operate” position, allowing circuits to be analyzed.
- SPDT, DPDT, 3PDT and 4PDT models
- Finger grip cover allows easier removal of relays from sockets than conventional relays
- I.D. tag/write labels for identifying relays in multi-relay circuits

78 Series Relays Selection Guide

NOTE: Not recommended for low current switching. Find contacts' Minimum Switching Requirement on following page.
 For low current switching, please see the QM4N1 and QM4X1 series.

Part Number	Price	Coil Voltage	Configuration	Dimensions	Relay Socket Part Number	Price	Dimensions
781-1C-12D	\$4.75	12VDC	SPDT	Figure 1	781-1C-SKT	\$4.00	Figure 5
781-1C-12A	\$4.75	12VAC					
781-1C-24D	\$4.50	24VDC					
781-1C-24A	\$4.75	24VAC					
781-1C-120A	\$4.75	120VAC					
781-1C-240A	\$5.25	240VAC					
782-2C-12D	\$5.50	12VDC	DPDT	Figure 2	782-2C-SKT	\$4.00	Figure 6
782-2C-12A	\$5.50	12VAC					
782-2C-24D	\$5.50	24VDC					
782-2C-24A	\$5.75	24VAC					
782-2C-120A	\$5.75	120VAC					
782-2C-240A	\$6.25	240VAC					
783-3C-12D	\$5.75	12VDC	3PDT	Figure 3	783-3C-SKT	\$4.50	Figure 7
783-3C-12A	\$7.75	12VAC					
783-3C-24D	\$8.25	24VDC					
783-3C-24A	\$8.25	24VAC					
783-3C-120A	\$8.25	120VAC					
783-3C-240A	\$8.25	240VAC					
784-4C-12D	\$7.25	12VDC	4PDT	Figure 4	784-4C-SKT-1	\$4.75	Figure 8
784-4C-12A	\$9.50	12VAC					
784-4C-24D	\$7.50	24VDC					
784-4C-24A	\$7.50	24VAC					
784-4C-120A	\$7.50	120VAC					
784-4C-240A	\$7.50	240VAC					

78 Series Electromechanical Relay Specifications

78 Series Relay Specification Table												
Part Numbers	781-1C-12D	781-1C-12A	781-1C-24D	781-1C-24A	781-1C-120A	781-1C-240A	782-2C-12D	782-2C-12A	782-2C-24D	782-2C-24A	782-2C-120A	782-2C-240A
General Specifications												
*Service Life: Mechanical / Electrical Operations	Mechanical: 10,000,000 operations unpowered Electrical: 100,000 operations @ rated resistive load											
Operating Temperature	-40°C to 55°C (-40°F to 131°F)											
Response Time	20ms											
Vibration Resistance	± 1mm (10-35 Hz) and 3gn (35-50Hz)											
Shock Resistance	15gn											
Weight	26g (0.92 oz)						36g (1.27 oz)					
**Agency Approvals and Standards	UL Recognized File E191059, CE, CSA											
Environmental Protection	IP40											
NEMA B300 Pilot Duty Rated	Yes											
Coil Specifications												
Standard	Mechanical flag indicator, LED Indicator, lockable push to test button											
Coil Input Voltage	12VDC	12VAC	24VDC	24VAC	120VAC	240VAC	12VDC	12VAC	24VDC	24VAC	120VAC	240VAC
Coil Resistance	115Ω	44Ω	450Ω	177Ω	4.43kΩ	17.72kΩ	177Ω	44Ω	640Ω	177Ω	4.43 kΩ	17.72 kΩ
Power Consumption	1.4 W DC, 1.9 VAC						1.15 W DC, 1.4 VAC					
Dropout Voltage (% of nominal voltage or more)	10%	15%	10%	15%		10%		15%	10%	15%		
Pull-in Voltage (% of nominal voltage or less)	85%	85%	85%	85%		80%		85%	80%	85%		
Max. Voltage (Max. continuous voltage)	110% of the rated coil voltage											
Contact Specifications												
Contact Type	SPDT						DPDT					
Contact Material	Silver alloy, gold flashed											
Minimum Switching Requirement	10mA @ 17VDC											
Max. Contact Rating	Refer to Contact Ratings charts.											
Dielectric Strength Between Contacts	Between coil contact: 2000V rms; Between poles 2000V rms; Between contacts 1500V rms											

*Note: These devices are rated for 1,000 cycles when used in a motor application. (Per Table 45.1, UL 508).

**Note: UL listed when used with sockets 781-1C-SKT, 782-2C-SKT, 783-3C-SKT, 784-4C-SKT, or 784-4C-SKT-1. Current limited to rating of relay or socket, whichever is less.

NEMA Mechanical Switching Ratings and Test Values for AC Control Circuit Contacts											
Contact Rating Designation	Thermal Continuous Test Current (A)	Maximum AC Current, 50/60Hz (A)								Voltamperes	
		120 Volts		240 Volts		480 Volts		600 Volts			
		Make	Break	Make	Break	Make	Break	Make	Break	Make	Break
B300	5	30	3.00	15	1.50	---	---	---	---	3600	360

This chart is provided as a guideline only, and the ratings and values are not guaranteed to be accurate. It is the users' responsibility to properly size their control circuit devices. The chart values are from NEMA Standard ICS 5-2000, Table 1-4-1.

781 Series Contact Ratings (current)				
Resistive				*Motor Load
Voltage	Nominal	UL	CSA	UL
28VDC	15A	15A	12A	---
120VAC	15A	15A	15A	1/2Hp
277VAC	15A	12A	12A	1Hp

782 Series Contact Ratings (current)				
Resistive				*Motor Load
Voltage	Nominal	UL	CSA	UL
28VDC	15A	15A	12A	---
120VAC	15A	15A	15A	1/2Hp
277VAC	15A	12A	12A	1Hp

78 Series Electromechanical Relay Specifications

78 Series Relay Specification Table												
Part Numbers	783-3C-12D	783-3C-12A	783-3C-24D	783-3C-24A	783-3C-120A	783-3C-240A	784-4C-12D	784-4C-12A	784-4C-24D	784-4C-24A	784-4C-120A	784-4C-240A
General Specifications												
*Service Life: Mechanical / Electrical Operations	Mechanical: 10,000,000 operations unpowered Electrical: 100,000 operations @ rated resistive load											
Operating Temperature	-40°C to 55°C (-40°F to 131°F)											
Response Time	20ms											
Vibration Resistance	± 1mm (10-35 Hz) and 3gn (35-100 Hz)											
Shock Resistance	15gn											
Weight	60g (2.12 oz)						80g (2.82 oz)					
**Agency Approvals and Standards	UL Recognized File E191059, CE, CSA											
Environmental Protection	IP40											
NEMA B300 Pilot Duty Rated	Yes											
Coil Specifications												
Standard	Mechanical flag indicator, LED Indicator, lockable push to test button											
Coil Input Voltage	12VDC	12VAC	24VDC	24VAC	120VAC	240VAC	12VDC	12VAC	24VDC	24VAC	120VAC	240VAC
Coil Resistance	80Ω	30Ω	320Ω	110Ω	2.88 kΩ	11.3 kΩ	76Ω	20Ω	303Ω	80Ω	2.1 kΩ	8kΩ
Power Consumption	1.85 W DC, 2.05 VAC						1.5 W DC, 1.5 VAC					
Dropout Voltage (% of nominal voltage or more)	10%	15%	10%	15%		10%		15%	10%	15%		
Pull-in Voltage (% of nominal voltage or less)	80%	85%	80%	85%		80%		85%	80%	85%		
Max. Voltage (Max. continuous voltage)	110% of the rated coil voltage											
Contact Specifications												
Contact Type	3PDT						4PDT					
Contact Material	Silver alloy, gold flashed											
Minimum Switching Requirement	10mA @ 17VDC											
Max. Contact Rating	Refer to Contact Ratings charts.											
Dielectric Strength Between Contacts	Between coil and contacts: 2000V rms; Between poles: 2000V rms; Between contacts: 1500V rms											

*Note: These devices are rated for 1,000 cycles when used in a motor application. (Per Table 45.1, UL 508).

**Note: UL listed when used with sockets 781-1C-SKT, 782-2C-SKT, 783-3C-SKT, 784-4C-SKT, or 784-4C-SKT-1. Current limited to rating of relay or socket, whichever is less.

783 Series Contact Ratings (current)				
Voltage	Resistive			*Motor Load
	Nominal	UL	CSA	UL
28VDC	15A	15A	15A @ 28VDC 30A max total	—
120VAC	15A	—	15A	1/2 hp
277VAC	15A	15A	15A @ 150VAC 30A max total	1hp 2hp max total

784 Series Contact Ratings (current)				
Voltage	Resistive			*Motor Load
	Nominal	UL	CSA	UL
28VDC	15A	15A	15A @ 28VDC 30A max total	—
120VAC	15A	—	15A	1/2Hp
277VAC	15A	15A	15A @ 150VAC 30A max total	1hp 2hp max total

*Note: These devices are rated for 1,000 cycles when applied to a motor application. (Per Table 46.1 UL 508)

78 Series Wiring Diagrams and Dimensions

Wiring Diagrams (viewed from pin end)

781-1C-XXX

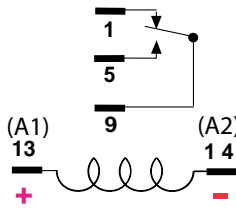

782-2C-XXX

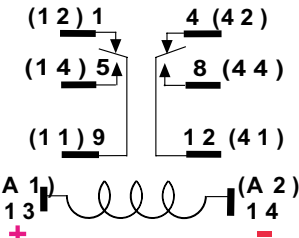

783-3C-XXX

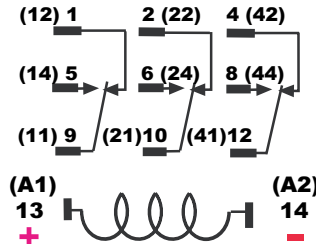

784-4C-XXX

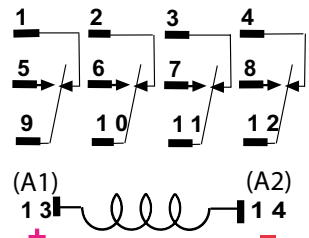

ALTERNATE NEMA OR IEC () NUMBERS, VIEWED FROM PIN SIDE

Dimensions

inches [mm]

Figure 1: 781-1C

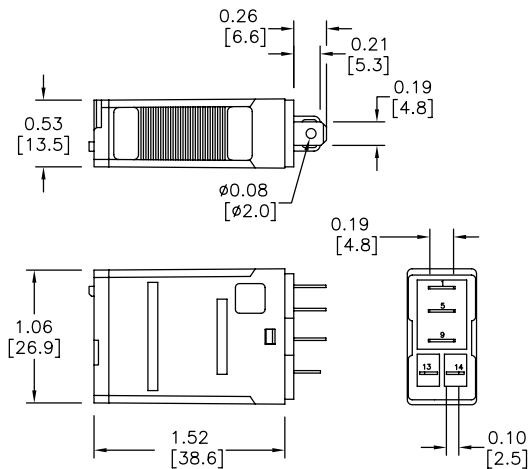

Figure 2: 782-2C

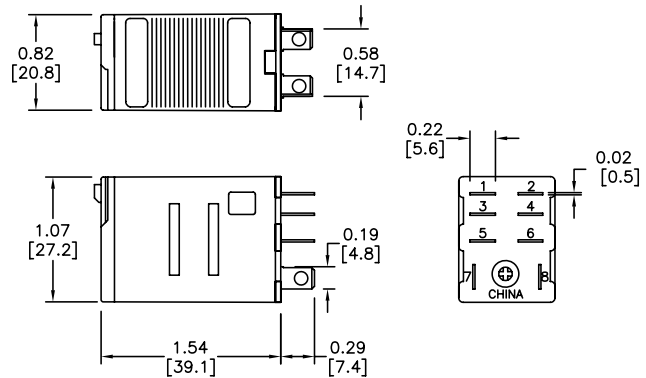

Figure 3: 783-3C

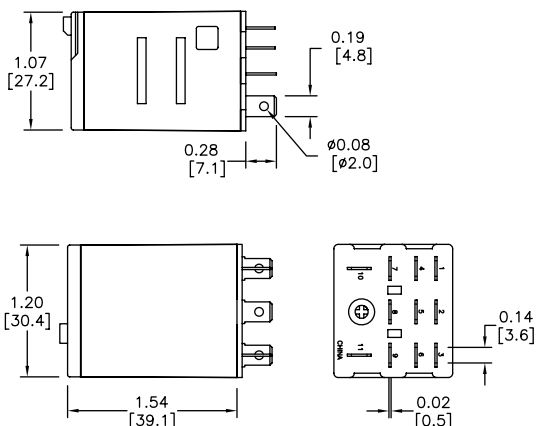
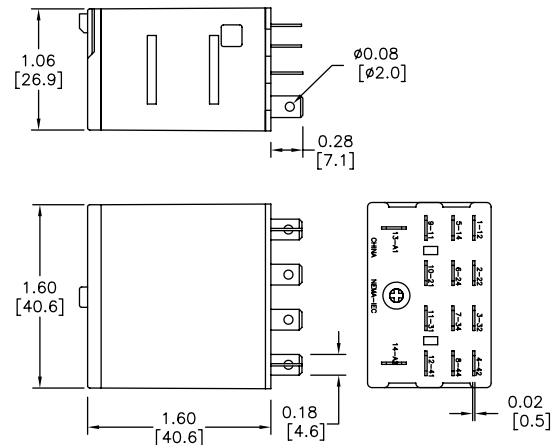

Figure 4: 784-4C



78 Series Relay Socket Dimensions

Dimensions

inches [mm]

Figure 5: 781-1C-SKT

DIN-rail mounting, SPDT, for use with 781 series relays

Note: See Table on next page for maximum screw torques and wire sizes

UL Recognized

file number: E225080

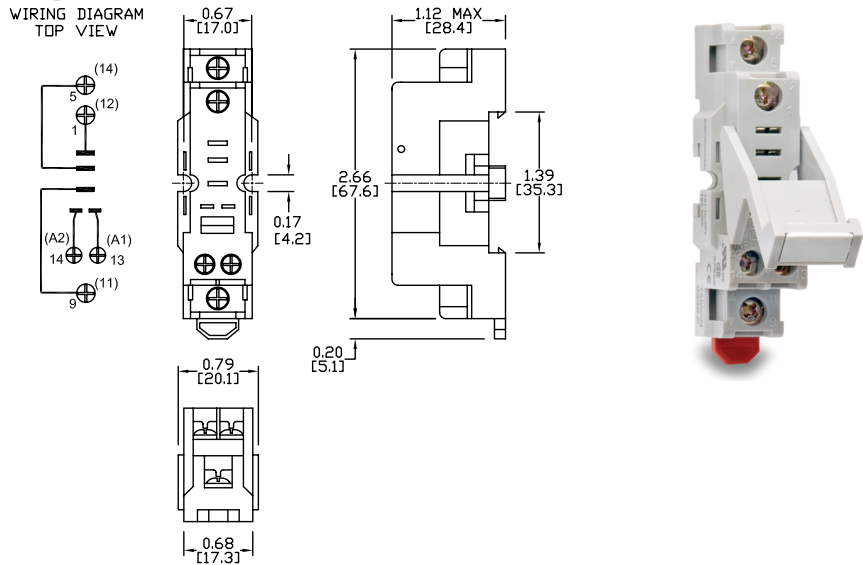

Figure 6: 782-2C-SKT

DIN-rail mounting, DPDT, for use with 782 series and AD-70S2 relays

Note: See Table on next page for maximum screw torques and wire sizes

UL Recognized

file number: E225080

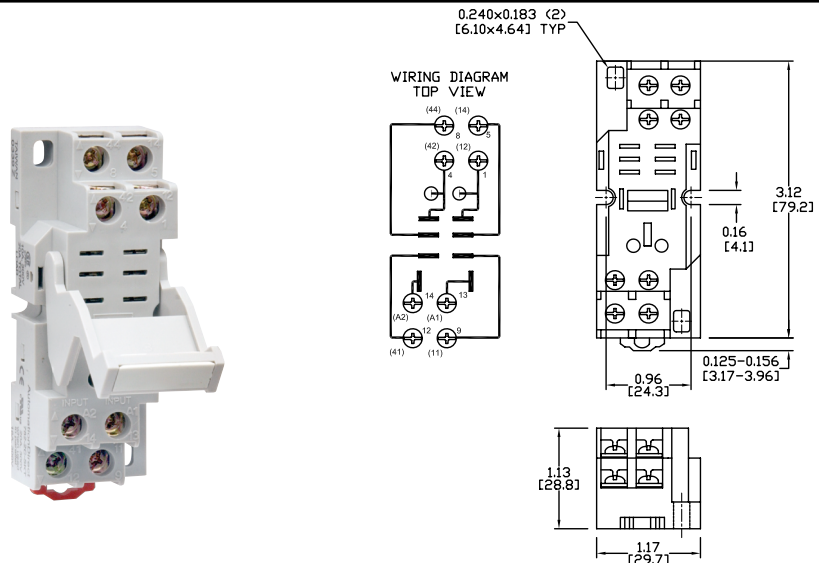

Figure 7: 783-3C-SKT

DIN-rail mounting, 3PDT, for use with 783 series relays.

Note: See Table on next page for maximum screw torques and wire sizes

UL Recognized

file number: E225080

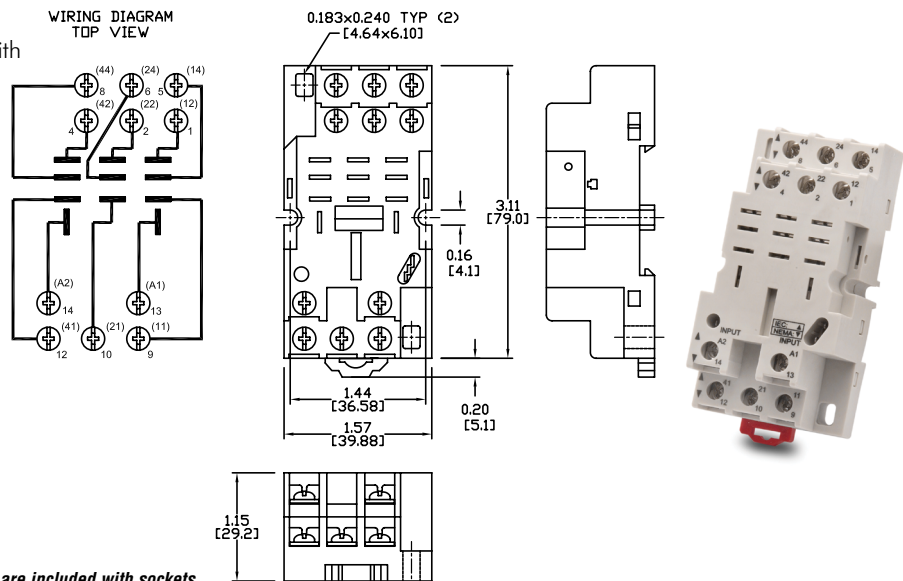

Note: Order sockets separately; holding clips are included with sockets.

78 Series Relay Socket Dimensions



Dimensions

inches [mm]

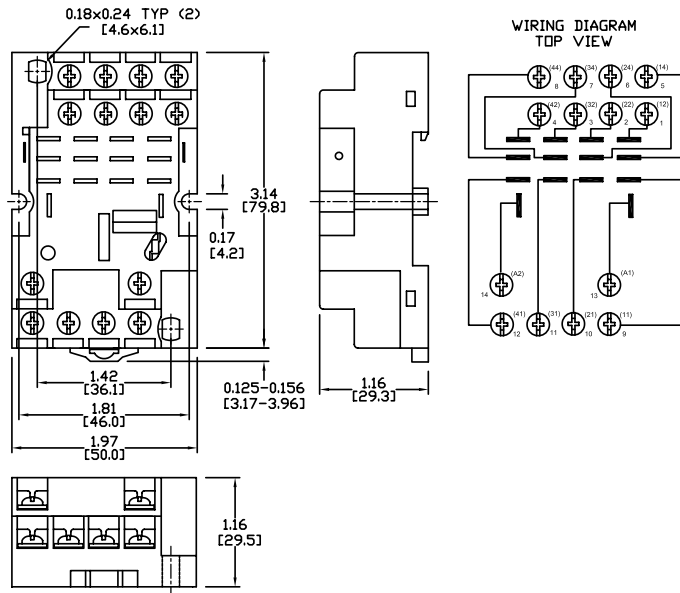

Figure 8: 784-4C-SKT-1

DIN-rail mounting, 4PDT,
for use with 784 series relays.

Note: Order sockets separately;
holding clips are included with sockets.

Note: See table below for maximum screw
torques and wire sizes

UL Recognized

file number: E225080

Part Number	Price	Maximum Screw Torques	Maximum Wire Sizes
781-1C-SKT	\$4.00	Terminals 13, 14: 7 in-lbs/0.8 N-m Terminals 1, 5, 9: 9 in-lbs/1.0 N-m	Terminals 13, 14: 18 to 20 AWG, solid or stranded, one or two identical wires Terminals 1, 5, 9: 12 to 20 AWG, solid or stranded, one or two identical wires
782-2C-SKT	\$4.00	All terminals: 9 in-lbs/1.0 N-m	All terminals: 12 to 20 AWG, solid or stranded, one or two identical wires
783-3C-SKT	\$4.50		
784-4C-SKT-1	\$4.75		

Packaged M.O.V.s and Diodes

Overview

Metal Oxide Varistors (MOV) and Diode circuits are offered as convenient plug-in modules. Plugging a module into the relay socket connects the circuit in parallel with the relay coil. No additional wiring is required.

Modules fit within the maximum dimensions of the relay and socket.

Features

- MOVs protect by shunting potentially damaging electrical spikes away from the relay coil. Ideal for AC and DC applications.
- Diodes protect external drive circuitry from inductive voltages generated when removing coil voltage. Ideal for DC applications. Polarity sensitive.

Application

Many PLC systems control one or more inductive load devices. These inductive loads (devices with a coil) generate transient voltages when they are de-energized with a relay contact. When a relay contact is closed it "bounces", which causes the coil to energize and de-energize until the "bouncing" stops. The transient voltage which is generated is much larger in amplitude than the supply voltage, especially with a DC supply voltage.

When switching a DC-supplied inductive load the full supply voltage is always present when the relay contact opens (or "bounces"). When switching an AC-supplied inductive load, if the voltage is not zero when the relay contact opens, there is energy stored in the inductor that is released when the voltage to the inductor is suddenly removed. This release of energy is what produces transient voltages.

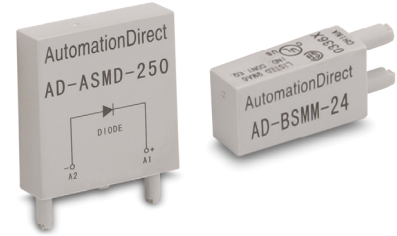

When inductive load devices (motors, motor starters, interposing relays, solenoids, valves, etc.) are controlled with relay contacts, it is recommended that a surge suppression device be connected directly across the coil of the field device. If the inductive device has plug-type connectors, the suppression device can be installed on the terminal block of the relay output.

Metal oxide varistors (MOV) and diodes are devices which provide good surge and transient suppression of AC and DC powered coils.

Protection Device Selection Guide					
Part Number	Price	Description	Nominal Input Voltage	Dimensions & Package	Mating Socket
AD-ASMD-250	\$9.75	Protection diode module for 784 and 75 series relays. Plug-in modules come in package of 5.	6-250VDC	Figure 1	783-3C-SKT 784-4C-SKT-1 750-2C-SKT 750-3C-SKT
AD-ASMM-24	\$8.00	MOV module for 784 and 75 series relays that operate at 24VAC coil voltage. Package includes 5 modules.	24VAC/VDC		
AD-ASMM-120	\$8.00	MOV module for 784 and 75 series relays that operate at 120VAC coil voltage. Package includes 5 modules.	120VAC/VDC		
AD-ASMM-240	\$8.00	MOV module for 784 and 75 series relays that operate at 240VAC coil voltage. Package includes 5 modules.	240VAC/VDC		
AD-BSMD-250	\$8.00	Protection diode module for 782 series relays. Plug-in modules come in package of 5.	6-250VDC	Figure 2	782-2C-SKT
AD-BSMM-24	\$8.00	MOV module for 782 series relays that operate at 24VAC coil voltage. Package includes 5 modules.	24VAC/VDC		
AD-BSMM-120	\$8.00	MOV module for 782 series relays that operate at 120VAC coil voltage. Package includes 5 modules.	120VAC/VDC		
AD-BSMM-240	\$8.00	MOV module for 782 series relays that operate at 240VAC coil voltage. Package includes 5 modules.	240VAC/VDC		

Accessory dimensions

inches [mm]

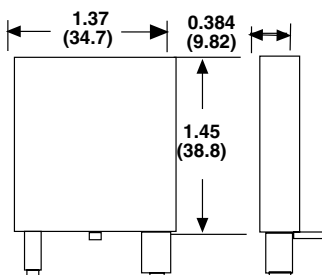

Figure 1

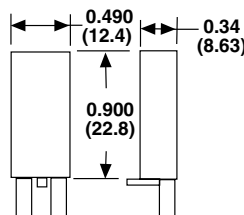

Figure 2

