

ST 78L05U (SOT-89)

3-Terminal Positive Voltage Regulator

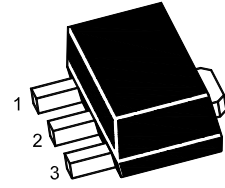

1.OUT 2.GND 3.IN
SOT-89 Plastic Package

Absolute Maximum Ratings ($T_a = 25\text{ }^\circ\text{C}$)

Parameter	Symbol	Rating	Unit
Input Voltage	V_i	30	V
Power Dissipation	P_{tot}	800 ¹⁾	mW
Operating Temperature	T_{opr}	-20~120	$^\circ\text{C}$
Storage Temperature Range	T_s	-55~150	$^\circ\text{C}$

¹⁾ 15 mm X 25 mm X 0.7 mm alumina ceramic board, $T_a \leq 25\text{ }^\circ\text{C}$

Electrical Characteristics ($T_a = 25\text{ }^\circ\text{C}$)

(Unless otherwise specified, $0\text{ }^\circ\text{C} \leq T_j \leq 125\text{ }^\circ\text{C}$, $V_i = 10\text{ V}$, $I_o = 40\text{ mA}$, $C_1 = 0.33\text{ }\mu\text{F}$, $C_0 = 0.1\text{ }\mu\text{F}$)

Parameter	Symbol	Test Condition	Min.	Typ.	Max.	Unit
Output Voltage	V_o	$T_j = 25\text{ }^\circ\text{C}$	4.8	5	5.2	V
		$7\text{ V} \leq V_i \leq 20\text{ V}$, $I_o = 1\text{ mA} - 40\text{ mA}$	4.75	-	5.25	V
		$7\text{ V} \leq V_i \leq V_{MAX}$, $I_o = 1\text{ mA} - 70\text{ mA}$	4.75	-	5.25	V
Load Regulation	ΔV_o	$I_o = 1\text{ mA} - 100\text{ mA}$, $T_j = 25\text{ }^\circ\text{C}$	-	11	60	mV
		$I_o = 1\text{ mA} - 40\text{ mA}$, $T_j = 25\text{ }^\circ\text{C}$	-	5.0	30	
Line Regulation	ΔV_o	$7\text{ V} \leq V_i \leq 20\text{ V}$, $T_j = 25\text{ }^\circ\text{C}$	-	8	150	mV
		$8\text{ V} \leq V_i \leq 20\text{ V}$, $T_j = 25\text{ }^\circ\text{C}$	-	1.6	50	
Quiescent Current	I_Q		-	2.0	5.5	mA
Quiescent Current Change	ΔI_Q	$8\text{ V} \leq V_i \leq 20\text{ V}$	-	-	1.5	mA
		$1\text{ mA} \leq I_o \leq 40\text{ mA}$	-	-	0.1	
Output Noise Voltage	V_N	$10\text{ Hz} \leq f \leq 100\text{ KHz}$	-	40	-	$\mu\text{V}/V_o$
Ripple Rejection	RR	$f = 120\text{ Hz}$, $8\text{ V} \leq V_i \leq 20\text{ V}$, $T_j = 25\text{ }^\circ\text{C}$	-	80	-	dB
Dropout Voltage	V_{Drop}	$T_j = 25\text{ }^\circ\text{C}$	-	1.7	-	V

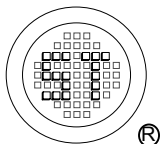
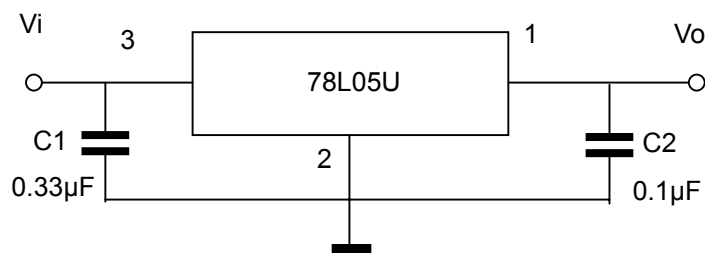

SEMTECH ELECTRONICS LTD.

(Subsidiary of Semtech International Holdings Limited, a company listed on the Hong Kong Stock Exchange, Stock Code: 724)

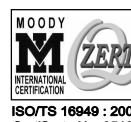

ST 78L05U (SOT-89)

SOT-89 PACKAGE OUTLINE

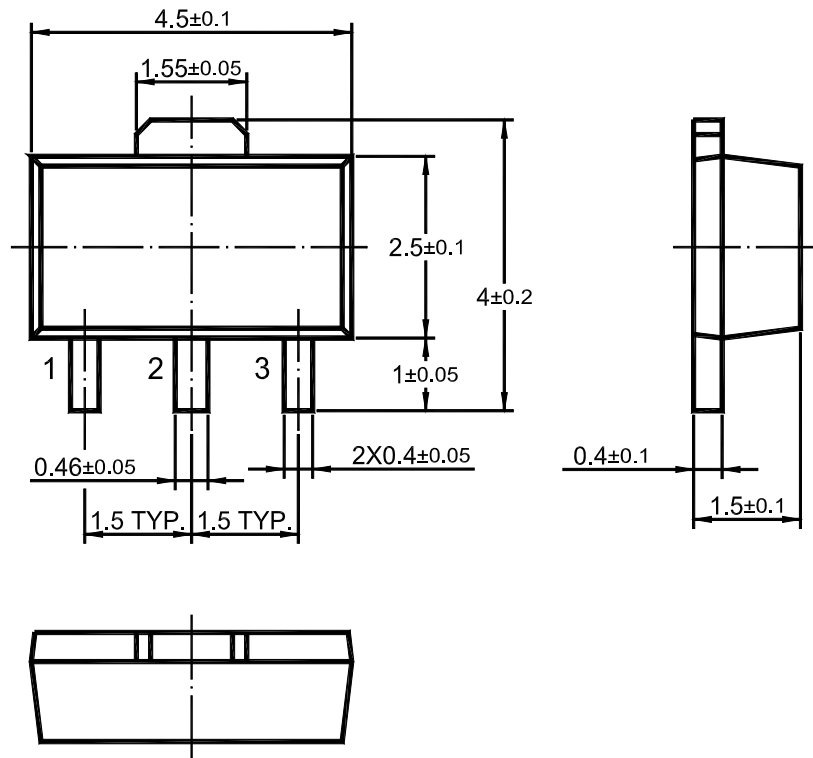

Dimensions in mm

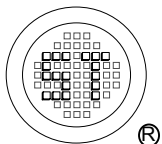

SEMTECH ELECTRONICS LTD.
(Subsidiary of Semtech International Holdings Limited, a company
listed on the Hong Kong Stock Exchange, Stock Code: 724)

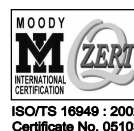

Dated : 22/03/2006 B