



## 78RXX

## LINEAR INTEGRATED CIRCUIT

### LOW DROPOUT VOLTAGE REGULATOR

#### DESCRIPTION

As the UTC linear integrated LDO, the UTC **78RXX** shows a high current, high accuracy, and specially low-dropout voltage. The features are: maximum 500mV dropout voltage, very low ground current. Cause the series have been designed for high current loads, so they are also used in lower current, extremely low dropout-critical systems (in which their tiny dropout voltage and ground current values are important attributes).

#### FEATURES

- \*  $I_{OUT}=1A$  ;  $V_{OUT}=1.5V, 1.8V, 3.3V, 5V, 6V, 9V, 12V$  (Typ)
- \* With ADJ version
- \* Internal overcurrent protection, internal thermal shutdown
- \* Internal overvoltage protection, internal short-circuit protection
- \* Output disable function

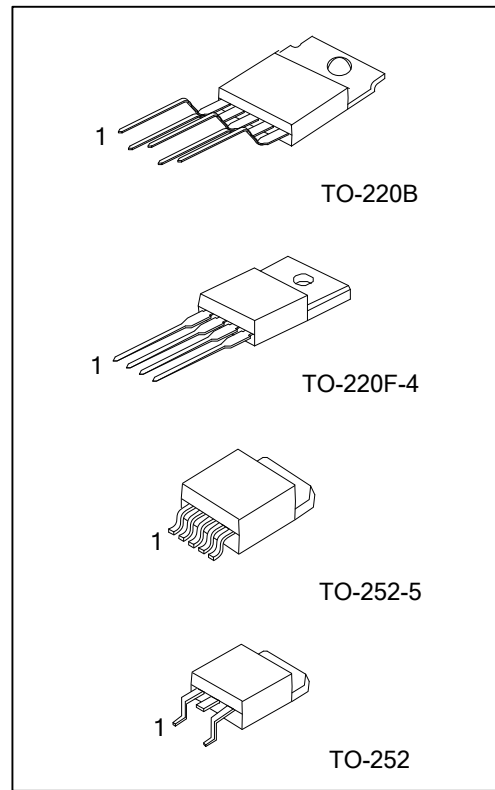

#### ORDERING INFORMATION

Ordering Number		Package	Packing
Lead Free	Halogen Free		
78RXXL-TB5-T	78RXXG-TB5-T	TO-220B	Tube
78RXXL-TF4-T	78RXXG-TF4-T	TO-220F-4	Tube
78RXXL-TN3-R	78RXXG-TN3-R	TO-252	Tape Reel
78RXXL-TN5-R	78RXXG-TN5-R	TO-252-5	Tape Reel

Note: xx: output voltage, refer to Marking Information

<p>78RXXL-TB5-T</p>	<p>(1) Packing Type (2) Package Type (3) Green Package (4) Voltage Code</p>	<p>(1) T: Tube, R: Tape Reel (2) TB5: TO-220B, TF4: TO-220F-4, TN3: TO-252, TN5: TO-252-5 (3) L: Lead Free, G: Halogen Free and Lead Free (4) xx: refer to Marking Information</p>
---------------------	---	--

### MARKING INFORMATION

PACKAGE	VOLTAGE CODE	MARKING
TO-220F-4 TO-252 TO-252-5	15:1.5V 18:1.8V 05:5.0V 06:6.0V 09:9.0V 33:3.3V 12:12V	<p>UTC 78RXX□</p> <p>Voltage Code ← □ □ □ □ → L: Lead Free Lot Code ← □ □ □ □ → G: Halogen Free Date Code</p>
TO-220B	15:1.5V 18:1.8V 05:5.0V 09:9.0V 33:3.3V 12:12V 00:ADJ	

### PIN DESCRIPTIONS

PIN NO.			PIN NAME	PIN FUNCTION
TO-220F-4/TO-220B	TO-252	TO-252-5		
1	1	1	V <sub>IN</sub>	Input voltage pin
2	3	3	V <sub>OUT</sub>	Output voltage pin
3	2	5	GND	GND
4	-	2	V <sub>DIS</sub>	Disable signal input pin
5	-	-	ADJ	Adjustable input pin ( FOR TO-220B )
-	-	4	NC	

## ■ BLOCK DIAGRAM

### Fixed Output Voltage Versions

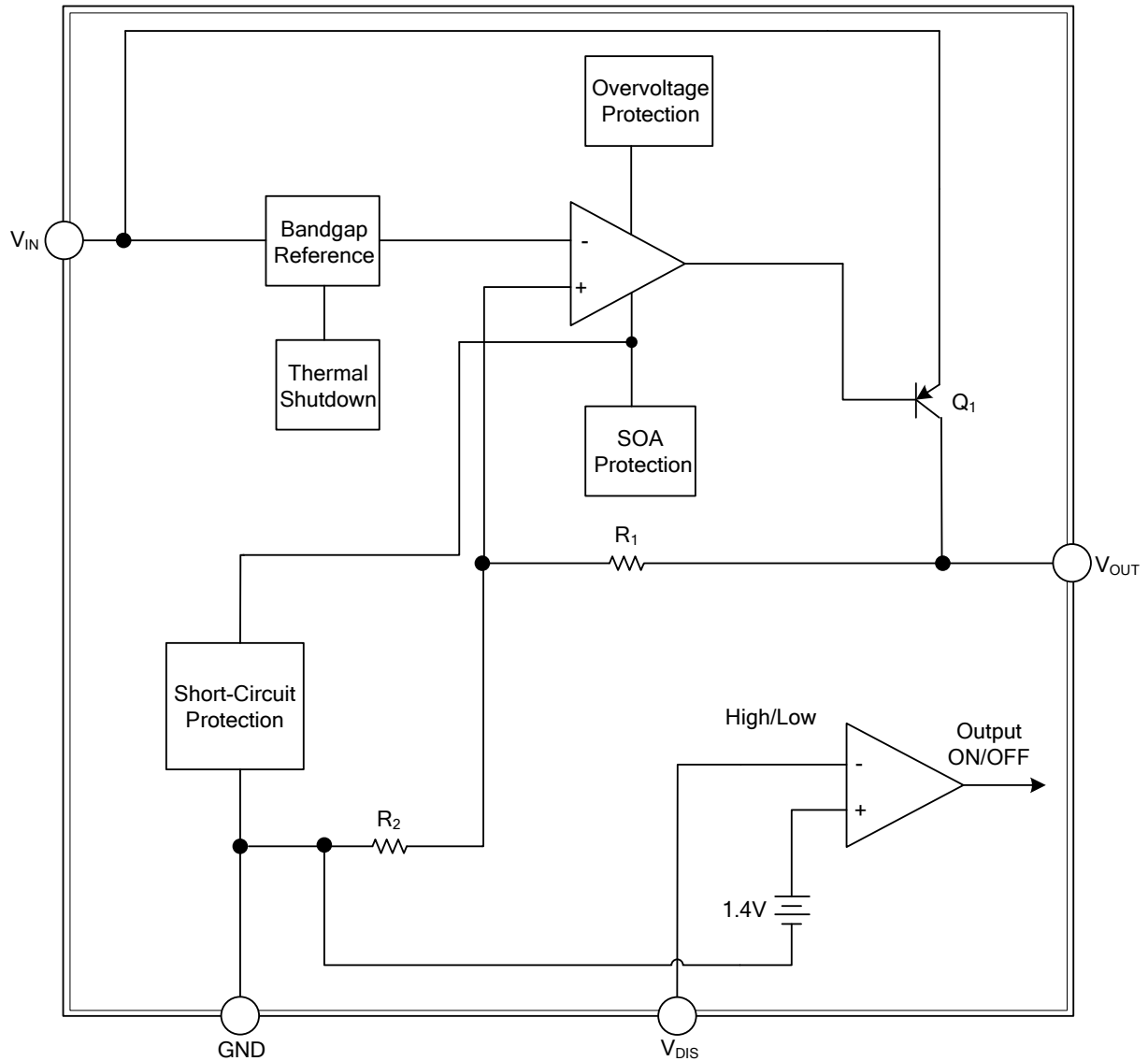

## ■ BLOCK DIAGRAM

### Adjustable Output Voltage Version

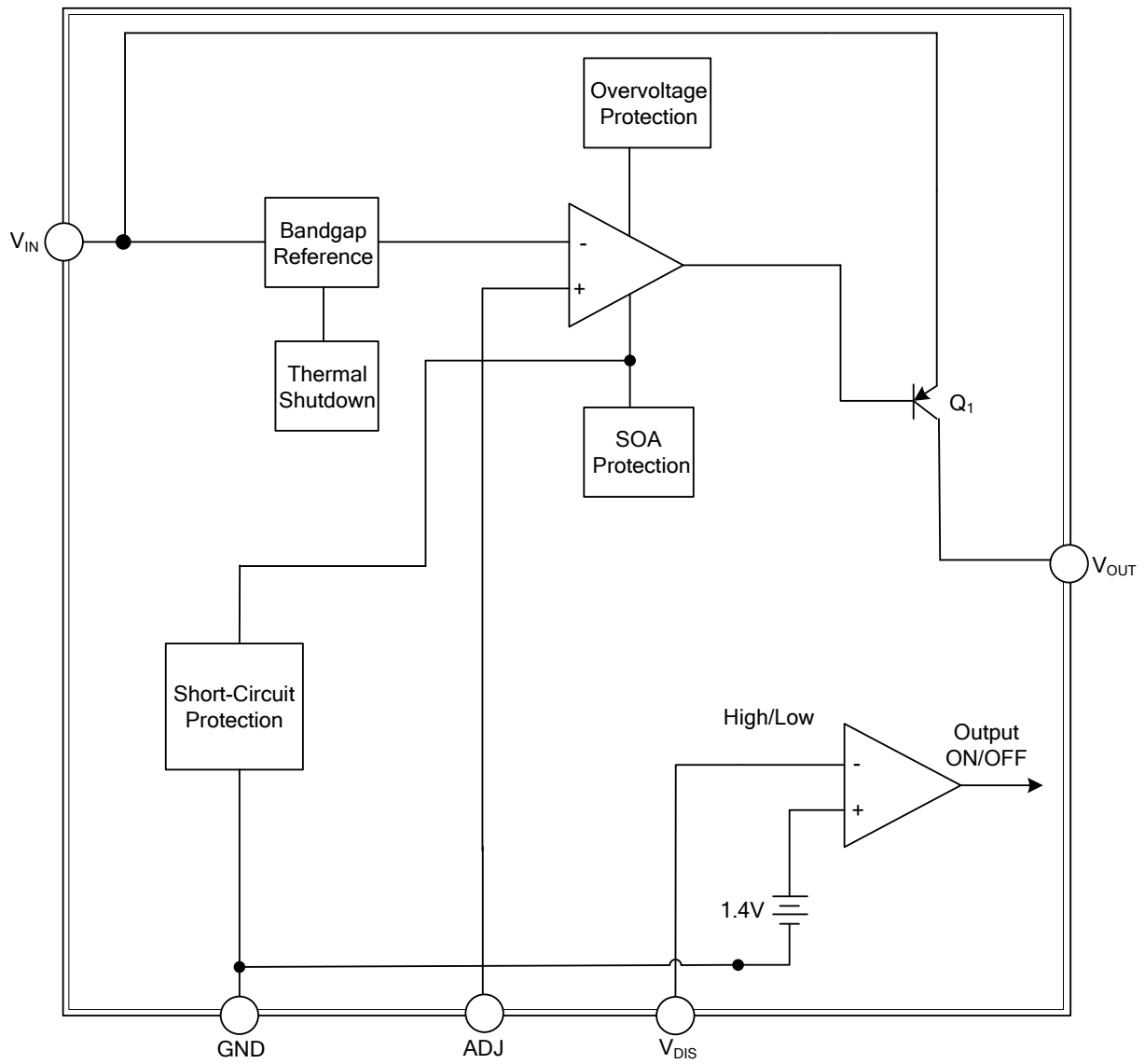

■ ABSOLUTE MAXIMUM RATINGS (Operating temperature range applies unless otherwise specified.)

PARAMETER		SYMBOL	RATINGS	UNITS
Input Voltage		$V_{IN}$	35	V
Disable Voltage		$V_{DIS}$	35	V
Output Current		$I_{OUT}$	1.0	A
Power Dissipation	TO-220B/TO-220F-4	$P_D$	1.5	W
	TO-252/TO-252-5		1	W
Junction Temperature		$T_J$	+150	°C
Operating Temperature		$T_{OPR}$	-40 ~ +85	°C

Note: Absolute maximum ratings are those values beyond which the device could be permanently damaged.

Absolute maximum ratings are stress ratings only and functional device operation is not implied.

■ THERMAL RESISTANCES CHARACTERISTICS

PARAMETER		SYMBOL	RATING	UNIT
Junction to Ambient	TO-220B/TO-220F-4	$\theta_{JA}$	62.5	°C/W
	TO-252/TO-252-5		110	°C/W
Junction to Case	TO-220B/TO-220F-4	$\theta_{JC}$	4	°C/W
	TO-252/TO-252-5		12	°C/W

■ ELECTRICAL CHARACTERISTICS ( $I_{OUT}=0.5A$ ,  $T_A = 25^\circ C$ , unless otherwise specified)

For 78R05 ( $V_{IN}=7V$ )

PARAMETER		SYMBOL	CONDITIONS	MIN	TYP	MAX	UNIT
Output Voltage		$V_{OUT}$	$V_{IN} = 7V$	4.88	5	5.12	V
Dropout Voltage		$V_D$	$I_{OUT} = 1A$		0.6	0.7	V
Load Regulation		$\Delta V_{OUT}$	$5mA < I_{OUT} < 1A$		0.1	2.0	%
Line Regulation		$\Delta V_{OUT}$	$6V < V_{IN} < 12V$		0.5	2.5	%
Quiescent Current		$I_Q$	$I_{OUT} = 0 A$			10	mA
Ripple Rejection		RR	(Note)	45	55		dB
Disable Voltage	High	$V_{DISH}$	Output Active	2.0			V
	Low	$V_{DISL}$	Output Disabled			0.8	V
Disable Bias Current	High	$I_{DISH}$	$V_{DIS} = 2.7V$			0.02	mA
	Low	$I_{DISL}$	$V_{DIS} = 0.4V$			-0.4	mA

For 78R06 ( $V_{IN}=8V$ )

PARAMETER		SYMBOL	CONDITIONS	MIN	TYP	MAX	UNIT
Output Voltage		$V_{OUT}$	$V_{IN} = 8V$	5.85	6	6.15	V
Dropout Voltage		$V_D$	$I_{OUT} = 1A$		0.6	0.7	V
Load Regulation		$\Delta V_{OUT}$	$5mA < I_{OUT} < 1A$		0.1	2.0	%
Line Regulation		$\Delta V_{OUT}$	$7V < V_{IN} < 12V$		0.5	2.5	%
Quiescent Current		$I_Q$	$I_{OUT} = 0 A$			10	mA
Ripple Rejection		RR	(Note)	45	55		dB
Disable Voltage	High	$V_{DISH}$	Output Active	2.0			V
	Low	$V_{DISL}$	Output Disabled			0.8	V
Disable Bias Current	High	$I_{DISH}$	$V_{DIS} = 2.7V$			0.02	mA
	Low	$I_{DISL}$	$V_{DIS} = 0.4V$			-0.4	mA

■ ELECTRICAL CHARACTERISTICS(Cont.)

**For 78R09** ( $V_{IN}=11V$ )

PARAMETER	SYMBOL	CONDITIONS	MIN	TYP	MAX	UNIT
Output Voltage	$V_{OUT}$	$V_{IN} = 11V$	8.78	9	9.22	V
Dropout Voltage	$V_D$	$I_{OUT} = 1A$			0.5	V
Load Regulation	$\Delta V_{OUT}$	$5mA < I_{OUT} < 1A$		0.1	2.0	%
Line Regulation	$\Delta V_{OUT}$	$10V < V_{IN} < 25V$		0.5	2.5	%
Quiescent Current	$I_Q$	$I_{OUT} = 0 A$			10	mA
Ripple Rejection	RR	(Note)	45	55		Db
Disable Voltage	High	$V_{DISH}$	2.0			V
	Low	$V_{DISL}$			0.8	V
Disable Bias Current	High	$I_{DISH}$			0.02	mA
	Low	$I_{DISL}$			-0.4	mA

**For 78R12** ( $V_{IN}=14V$ )

PARAMETER	SYMBOL	CONDITIONS	MIN	TYP	MAX	UNIT
Output Voltage	$V_{OUT}$	$V_{IN} = 14V$	11.71	12	12.29	V
Dropout Voltage	$V_D$	$I_{OUT} = 1A$			0.5	V
Load Regulation	$\Delta V_{OUT}$	$5mA < I_{OUT} < 1A$		0.1	2.0	%
Line Regulation	$\Delta V_{OUT}$	$13 V < V_{IN} < 25V$		0.5	2.5	%
Quiescent Current	$I_Q$	$I_{OUT} = 0 A$			10	mA
Ripple Rejection	RR	(Note)	45	55		Db
Disable Voltage	High	$V_{DISH}$	2.0			V
	Low	$V_{DISL}$			0.8	V
Disable Bias Current	High	$I_{DISH}$			0.02	mA
	Low	$I_{DISL}$			-0.4	mA

**For 78R15** ( $V_{IN}=4.5V$ )

PARAMETER	SYMBOL	CONDITIONS	MIN	TYP	MAX	UNIT
Output Voltage	$V_{OUT}$		1.46	1.5	1.54	V
Dropout Voltage	$V_D$	$I_{OUT} = 1A$		2.7	3.0	V
Load Regulation	$\Delta V_{OUT}$	$5mA < I_{OUT} < 1A$		0.1	2.0	%
Line Regulation	$\Delta V_{OUT}$	$4.5V < V_{IN} < 8.5V$		0.5	2.5	%
Quiescent Current	$I_Q$	$I_{OUT} = 0 A$			10	mA
Ripple Rejection	RR	(Note)	45	55		dB
Disable Voltage	High	$V_{DISH}$	2.0			V
	Low	$V_{DISL}$			0.8	V
Disable Bias Current	High	$I_{DISH}$			0.02	mA
	Low	$I_{DISL}$			-0.4	mA

**For 78R18** ( $V_{IN}=4.8V$ )

PARAMETER	SYMBOL	CONDITIONS	MIN	TYP	MAX	UNIT
Output Voltage	$V_{OUT}$		1.75	1.8	1.85	V
Dropout Voltage	$V_D$	$I_{OUT} = 1A$		2.4	2.7	V
Load Regulation	$\Delta V_{OUT}$	$5mA < I_{OUT} < 1A$		0.1	2.0	%
Line Regulation	$\Delta V_{OUT}$	$4.5V < V_{IN} < 9V$		0.5	2.5	%
Quiescent Current	$I_Q$	$I_{OUT} = 0 A$			10	mA
Ripple Rejection	RR	(Note)	45	55		dB
Disable Voltage	High	$V_{DISH}$	2.0			V
	Low	$V_{DISL}$			0.8	V
Disable Bias Current	High	$I_{DISH}$			0.02	mA
	Low	$I_{DISL}$			-0.4	mA

■ ELECTRICAL CHARACTERISTICS(Cont.)

For 78R33 ( $V_{IN}=5V$ )

PARAMETER		SYMBOL	CONDITIONS	MIN	TYP	MAX	UNIT
Output Voltage		$V_{OUT}$	$V_{IN} = 5V$	3.22	3.3	3.38	V
Dropout Voltage		$V_D$	$I_{OUT} = 1A$			0.5	V
Load Regulation		$\Delta V_{OUT}$	$5mA < I_{OUT} < 1A$		0.1	2.0	%
Line Regulation		$\Delta V_{OUT}$	$4.5V < V_{IN} < 10V$		0.5	2.5	%
Quiescent Current		$I_Q$	$I_{OUT} = 0 A$			10	mA
Ripple Rejection		RR	(Note)	45	55		dB
Disable Voltage	High	$V_{DISH}$	Output Active	2.0			V
	Low	$V_{DISL}$	Output Disabled			0.8	V
Disable Bias Current	High	$I_{DISH}$	$V_{DIS} = 2.7V$			0.02	mA
	Low	$I_{DISL}$	$V_{DIS} = 0.4V$			-0.4	mA

For 78R00-ADJ

PARAMETER		SYMBOL	CONDITIONS	MIN	TYP	MAX	UNIT
Output Voltage		$V_{OUT}$		1.22	1.25	1.28	V
Dropout Voltage		$V_D$	$I_{OUT} = 1A$			0.5	V
Load Regulation		$\Delta V_{OUT}$	$5mA < I_{OUT} < 1A$		0.1	2.0	%
Line Regulation		$\Delta V_{OUT}$	$V_O+1V < V_{IN} < V_O+7V$		0.5	2.5	%
Quiescent Current		$I_Q$	$I_{OUT} = 0 A$			10	mA
Ripple Rejection		RR	(Note)	45	55		dB
Disable Voltage	High	$V_{DISH}$	Output Active	2.0			V
	Low	$V_{DISL}$	Output Disabled			0.8	V
Disable Bias Current	High	$I_{DISH}$	$V_{DIS} = 2.7V$			0.02	mA
	Low	$I_{DISL}$	$V_{DIS} = 0.4V$			-0.4	mA

Note: These guaranteed parameters, are not 100% tested in production.

## ■ TYPICAL APPLICATION CIRCUIT

### Fixed Output Voltage Versions

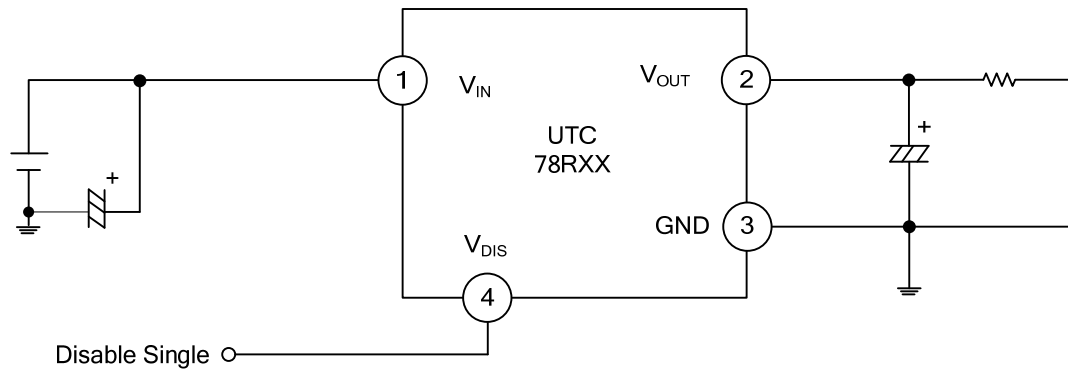

\*  $C_i$  is required if regulator is located an appreciable distance from power supply filter. [ $C_i > 0.33\mu\text{F}$  (Electrolytic)]

\*  $C_o$  improves stability and transient response. [ $C_o > 47\mu\text{F}$ (Electrolytic)]

### Adjustable Output Voltage Version

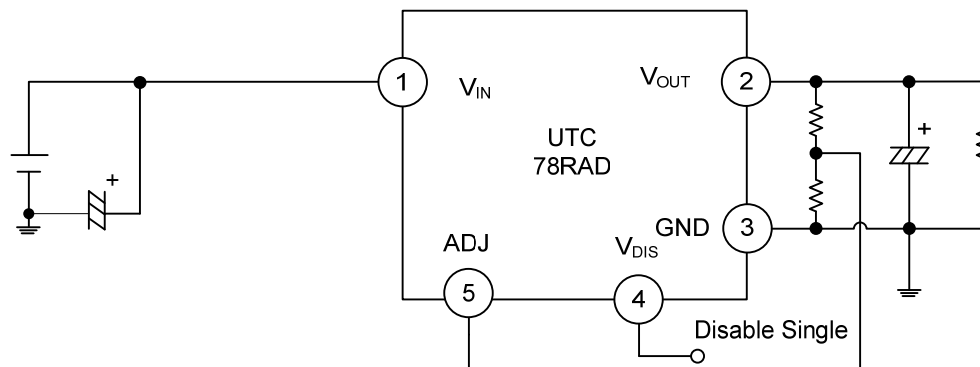

\*  $C_i$  is required if regulator is located an appreciable distance from power supply filter. [ $C_i > 0.33\mu\text{F}$  (Electrolytic)]

\*  $C_o$  improves stability and transient response. [ $C_o > 47\mu\text{F}$ (Electrolytic)]



## ■ TYPICAL CHARACTERISTICS

### (1) 78R33

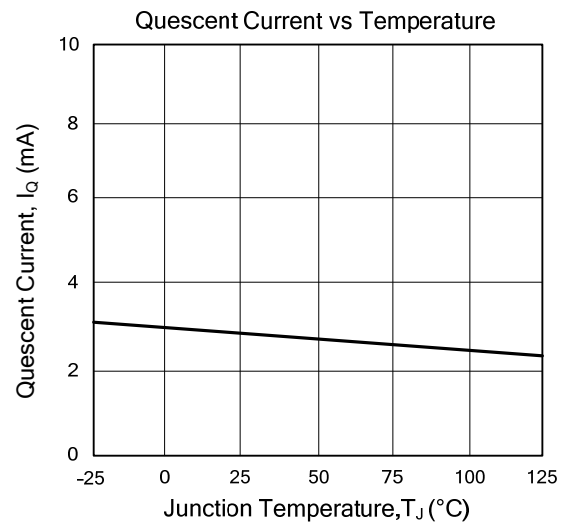
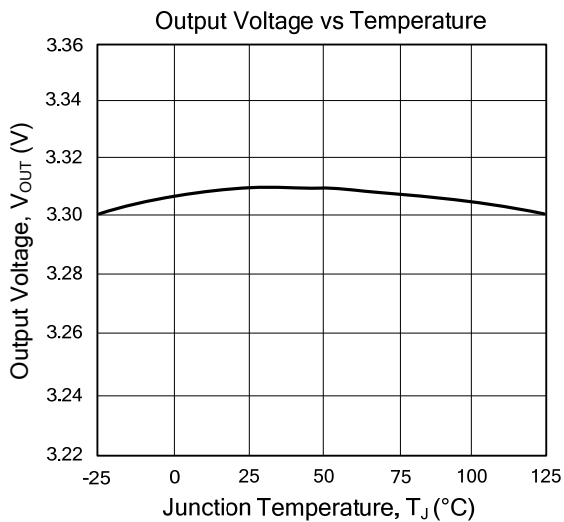
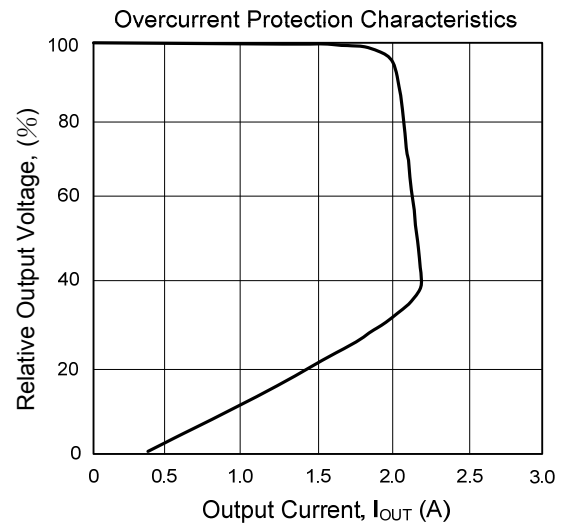
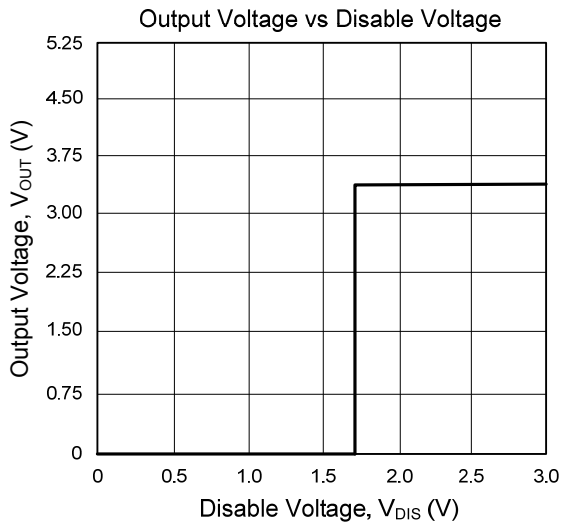
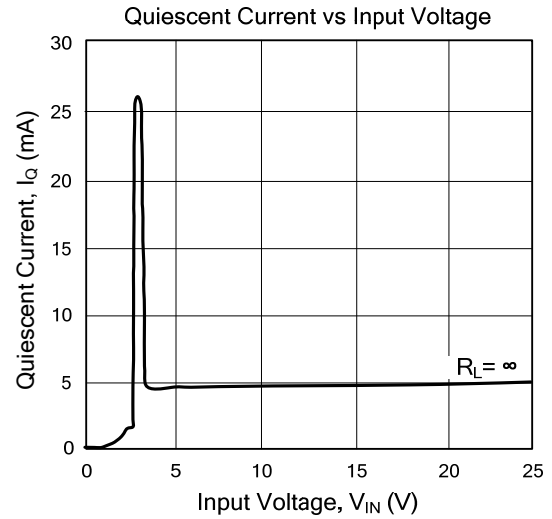
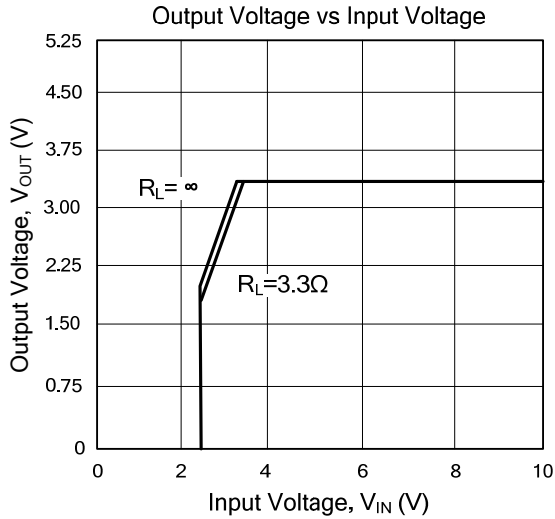

■ TYPICAL CHARACTERISTICS(Cont.)

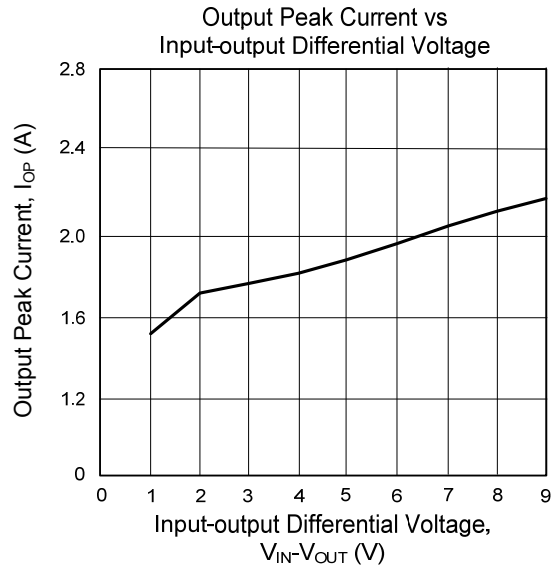

(2) 78R05

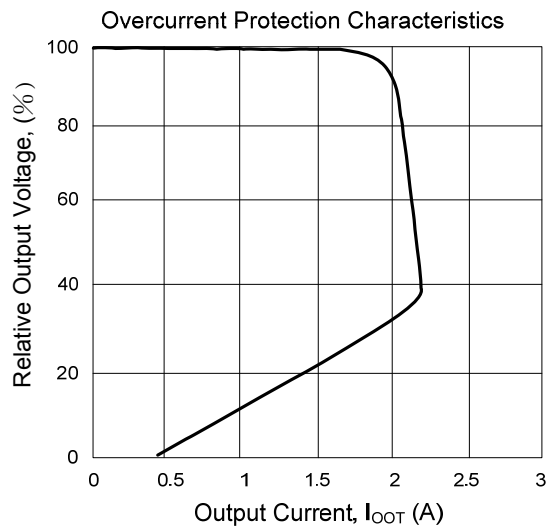
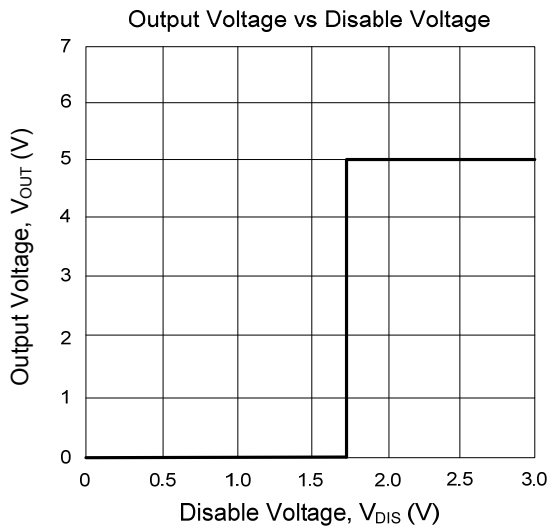
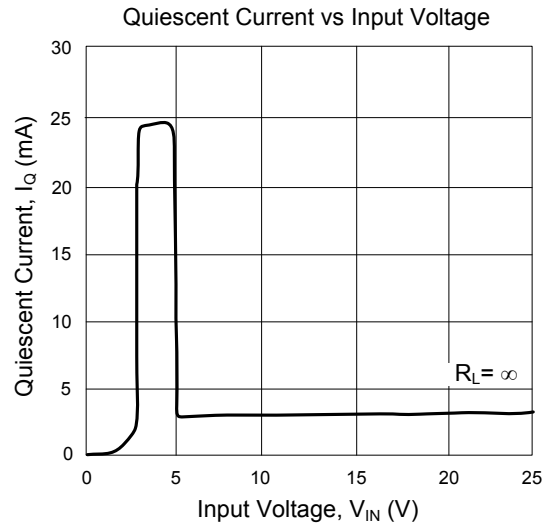
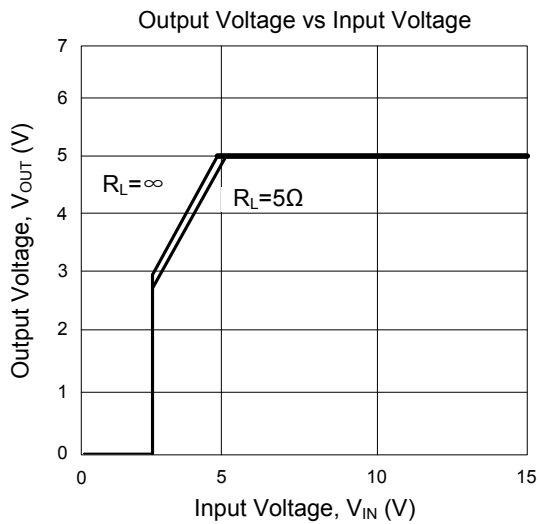

## ■ TYPICAL CHARACTERISTICS(Cont.)

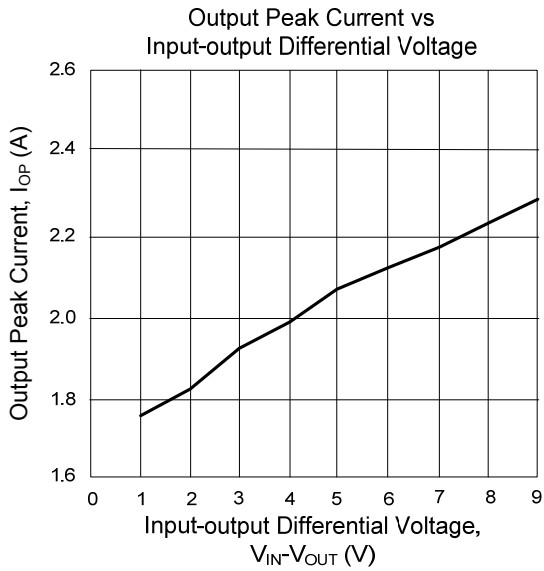
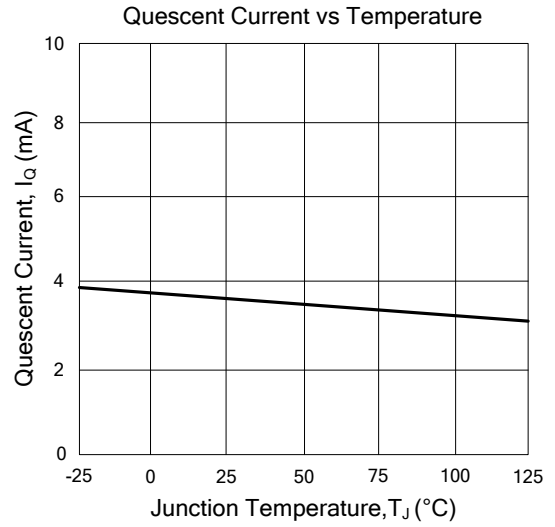
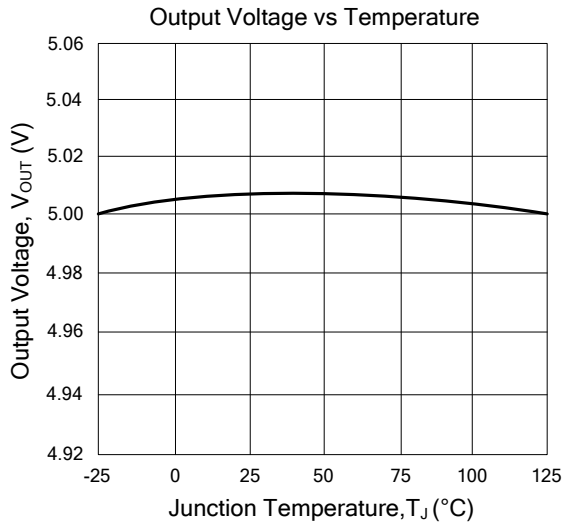

### (3) 78R09

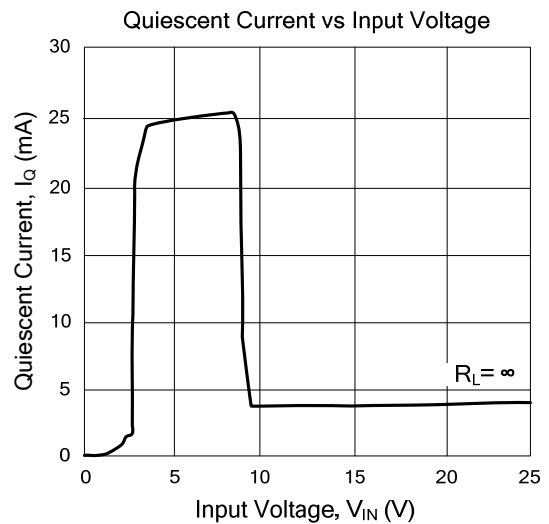
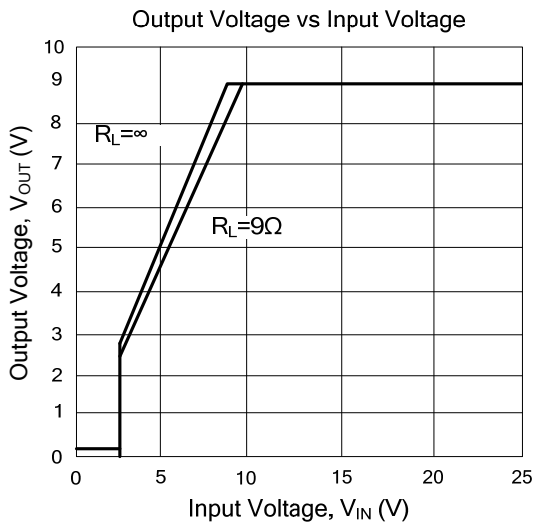

■ TYPICAL CHARACTERISTICS(Cont.)

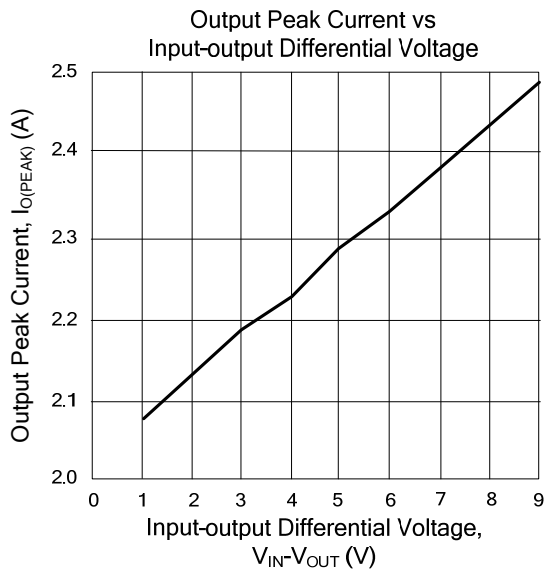
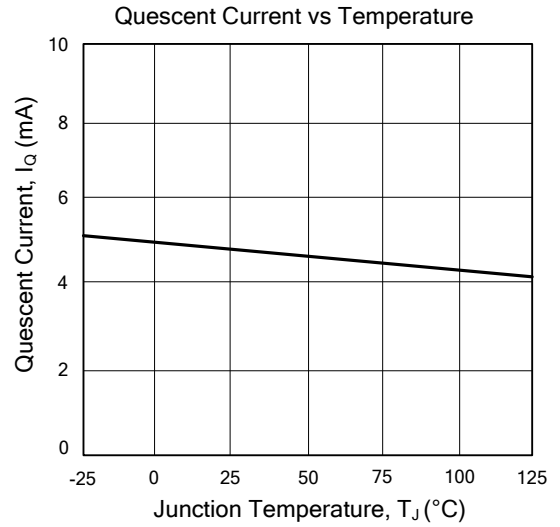
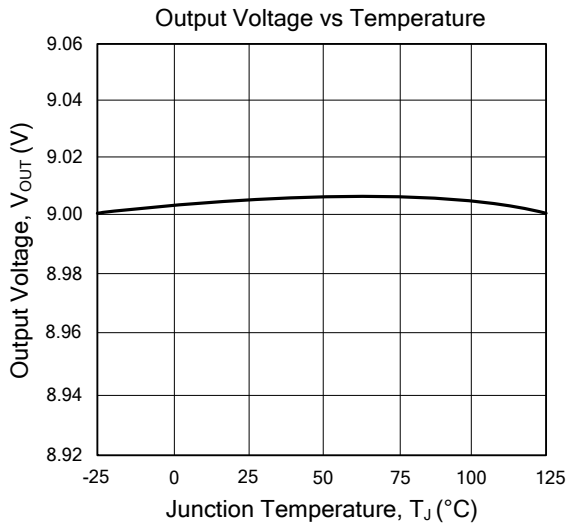
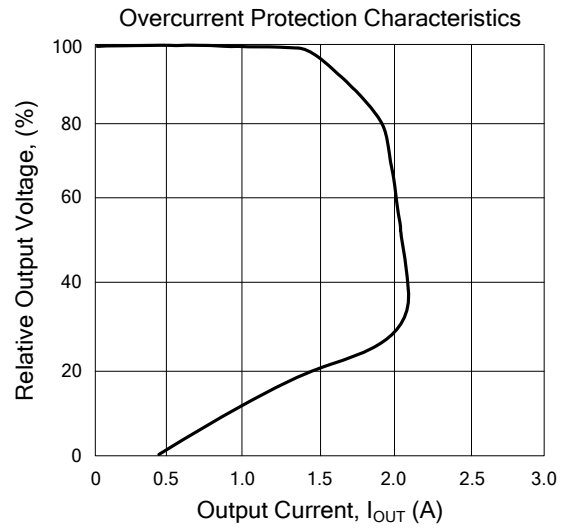
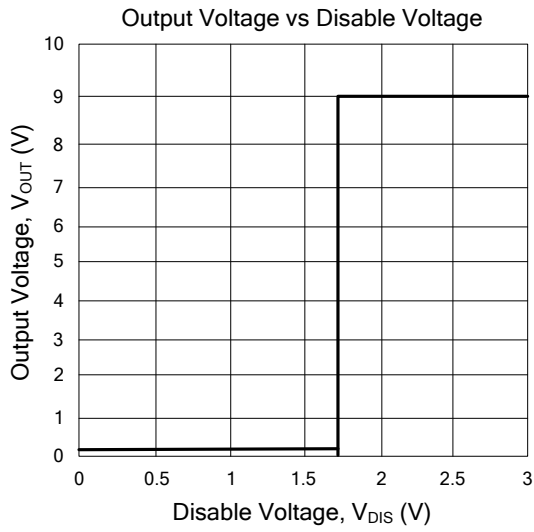

UTC assumes no responsibility for equipment failures that result from using products at values that exceed, even momentarily, rated values (such as maximum ratings, operating condition ranges, or other parameters) listed in products specifications of any and all UTC products described or contained herein. UTC products are not designed for use in life support appliances, devices or systems where malfunction of these products can be reasonably expected to result in personal injury. Reproduction in whole or in part is prohibited without the prior written consent of the copyright owner. The information presented in this document does not form part of any quotation or contract, is believed to be accurate and reliable and may be changed without notice.