

## IGBT MODULE ( N series )

### ■ Features

- Including Brake Chopper
- Square RBSOA
- Low Saturation Voltage
- Overcurrent Limiting Function  
( ~ 3 Times Rated Current )

### ■ Equivalent Circuit

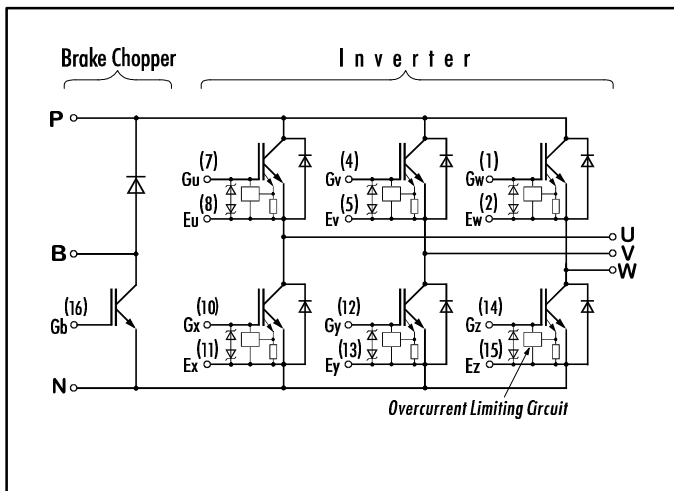

### ■ Outline Drawing

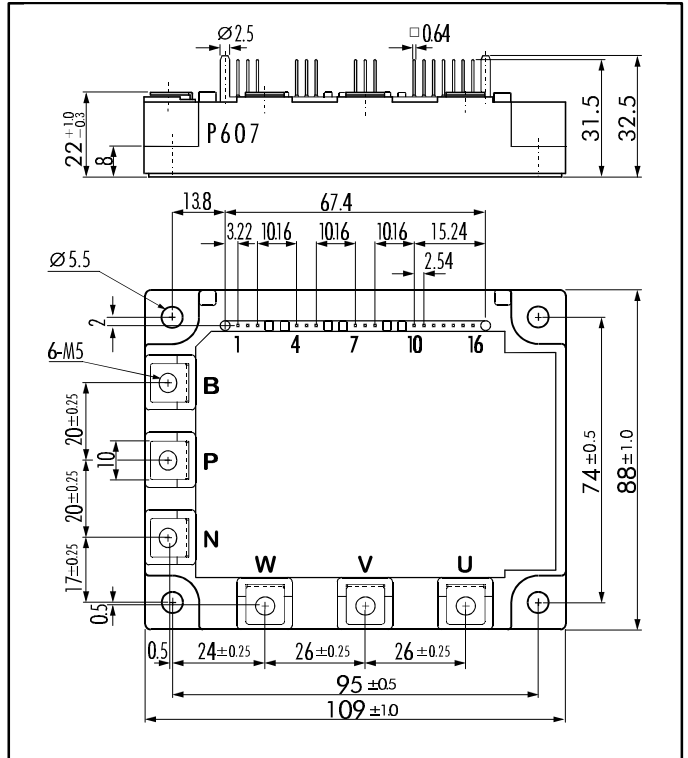

### ■ Absolute Maximum Ratings ( T<sub>c</sub>=25°C )

Items		Symbols	Test Conditions	Ratings	Units
Inverter	Collector-Emitter Voltage	V <sub>CES</sub>		600	V
	Gate -Emitter Voltage	V <sub>GES</sub>		± 20	
	Collector Current	I <sub>C</sub>	Continuous	100	A
		I <sub>C PULSE</sub>	1ms	200	
	Collector Power Dissipation	P <sub>C</sub>	1 device	400	W
Brake Chopper	Collector-Emitter Voltage	V <sub>CES</sub>		600	V
	Gate -Emitter Voltage	V <sub>GES</sub>		± 20	
	Collector Current	I <sub>C</sub>	Continuous	50	A
		I <sub>C PULSE</sub>	1ms	100	
	Collector Power Dissipation	P <sub>C</sub>	1 device	200	W
	Repetitive Peak Reverse Voltage	V <sub>RRM</sub>		600	V
	Average Forward Current	I <sub>F(AV)</sub>		1	A
Surge Current	I <sub>FSM</sub>	10ms	50		
Operating Junction Temperature	T <sub>j</sub>		+150	°C	
Storage Temperature	T <sub>Stg</sub>		-40 ~ +125		
Isolation Voltage	V <sub>ISO</sub>	A.C. 1min.	2500	V	
Mounting Screw Torque *1			3.5	Nm	
Terminal Screw Torque *1			3.5		

Note: \*1:Recommendable Value; 2.5 ~ 3.5 Nm (M5)

## ■ Electrical Characteristics ( $T_j=25^\circ\text{C}$ )

		Items	Symbols	Test Conditions	Min.	Max.	Units
Inverter	IGBT	Zero Gate Voltage Collector Current	$I_{CES}$	$V_{GE}=0V$ $V_{CE}=600V$		3.0	mA
		Gate-Emitter Leakage Current	$I_{GES}$	$V_{CE}=0V$ $V_{GE}=\pm 20V$		15	$\mu\text{A}$
		Gate-Emitter Threshold Voltage	$V_{GE(th)}$	$V_{GE}=20V$ $I_C=100\text{mA}$	4.5	7.5	V
		Collector-Emitter Saturation Voltage	$V_{CE(sat)}$	$V_{GE}=15V$ $I_C=100A$		2.8	
		Input capacitance	$C_{ies}$	$f=1\text{MHz}$ , $V_{GE}=0V$ , $V_{CE}=10V$		6600 (typ.)	pF
		Turn-on Time	$t_{on}$	$V_{CC}=300V$ $I_C = 100A$		1.2	$\mu\text{s}$
		Turn-off Time	$t_{off}$	$V_{GE}=\pm 15V$		1.5	
$t_f$	$R_G = 24\Omega$			0.35			
FWD	FWD	Diode Forward On-Voltage	$V_F$	$I_F=100A$ $V_{GE}=0V$		3.3	V
		Reverse Recovery Time	$t_{rr}$	$I_F=100A$ ; $V_{GE}=-10V$ ; $-di/dt=300\text{A}/\mu\text{s}$		300	ns
Brake Chopper	IGBT	Zero Gate Voltage Collector Current	$I_{CES}$	$V_{GE}=0V$ $V_{CE}=600V$		1.0	mA
		Gate-Emitter Leakage Current	$I_{GES}$	$V_{CE}=0V$ $V_{GE}=\pm 20V$		100	nA
		Collector-Emitter Saturation Voltage	$V_{CE(sat)}$	$V_{GE}=15V$ $I_C=50A$		2.8	V
		Turn-on Time	$t_{on}$	$V_{CC}=300V$ $I_C = 50A$		1.2	$\mu\text{s}$
			Turn-off Time	$t_{off}$	$V_{GE}=\pm 15V$		
		$t_f$		$R_G = 51\Omega$		0.35	
		FWD	FWD	Reverse Current	$I_{RRM}$	$V_R=600V$	
Reverse Recovery Time	$t_{rr}$					600	ns

## ■ Thermal Characteristics

Items	Symbols	Test Conditions	Min.	Max.	Units
Thermal Resistance (1 device)	$R_{th(f-c)}$	Inverter IGBT		0.31	$^\circ\text{C/W}$
		Inverter FRD		0.90	
		Brake IGBT		0.63	
Contact Thermal Resistance	$R_{th(c-f)}$	With Thermal Compound	0.05 (typ.)		

Collector current vs. Collector-Emitter voltage  
 $T_j=25^\circ\text{C}$

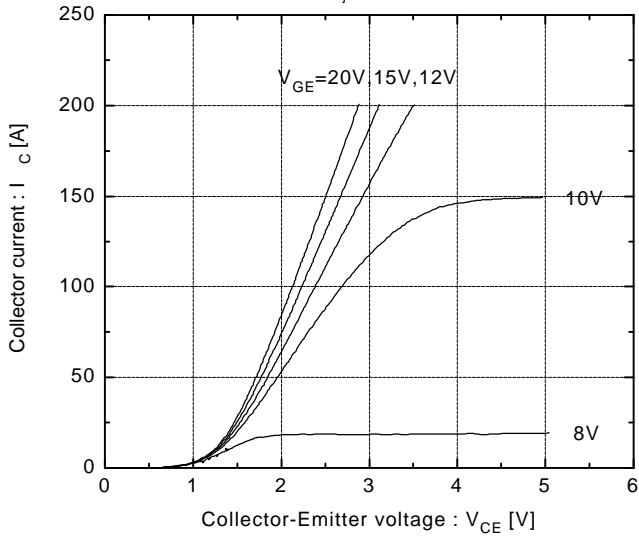

Collector current vs. Collector-Emitter voltage  
 $T_j=125^\circ\text{C}$

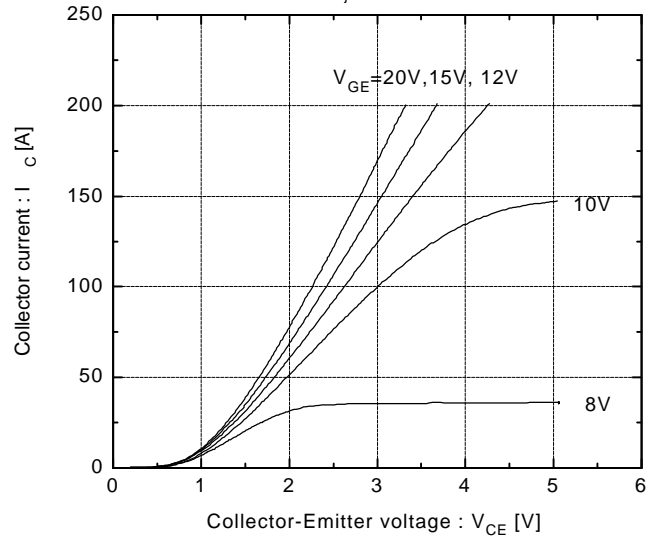

Collector-Emitter vs. Gate-Emitter voltage  
 $T_j=25^\circ\text{C}$

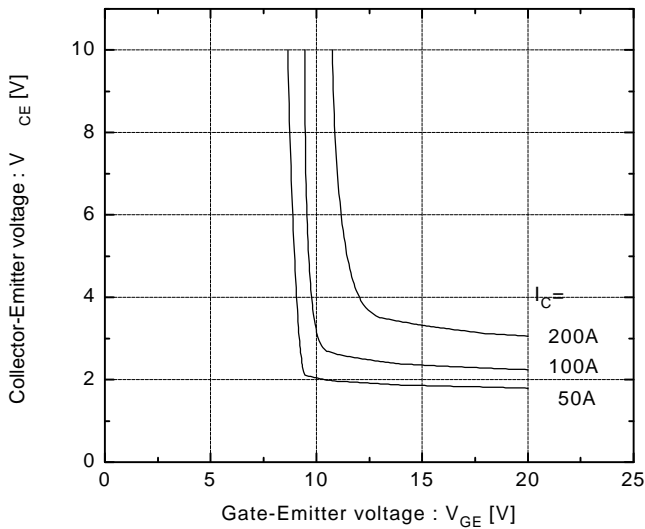

Collector-Emitter vs. Gate-Emitter voltage  
 $T_j=125^\circ\text{C}$

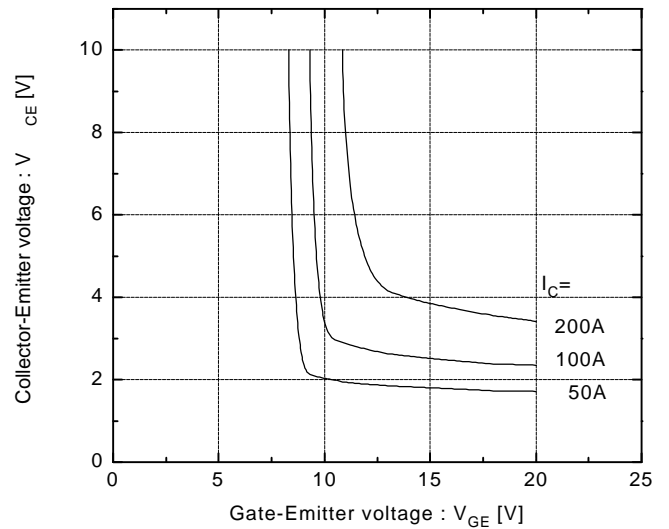

Switching time vs. Collector current  
 $V_{CC}=300\text{V}, R_G=24\Omega, V_{GE}=\pm 15\text{V}, T_j=25^\circ\text{C}$

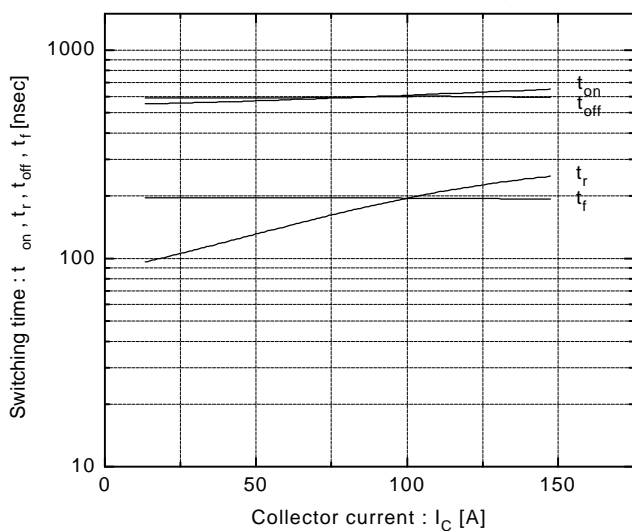

Switching time vs. Collector current  
 $V_{CC}=300\text{V}, R_G=24\Omega, V_{GE}=\pm 15\text{V}, T_j=125^\circ\text{C}$

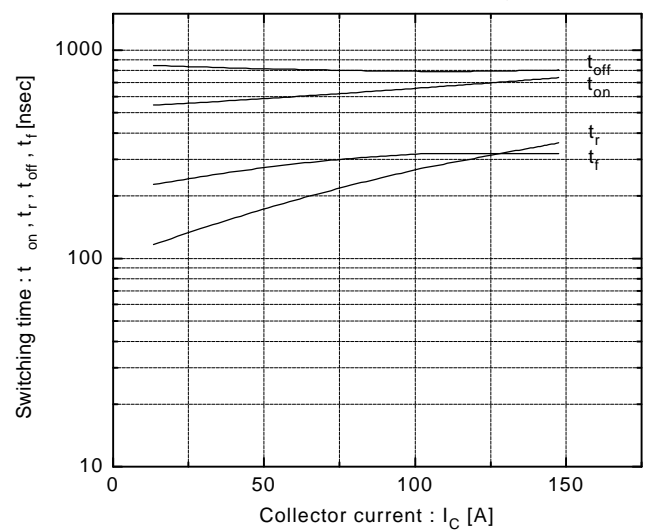

Switching time vs.  $R_G$

$V_{CC}=300V, I_C=100A, V_{GE}=\pm 15V, T_J=25^\circ C$

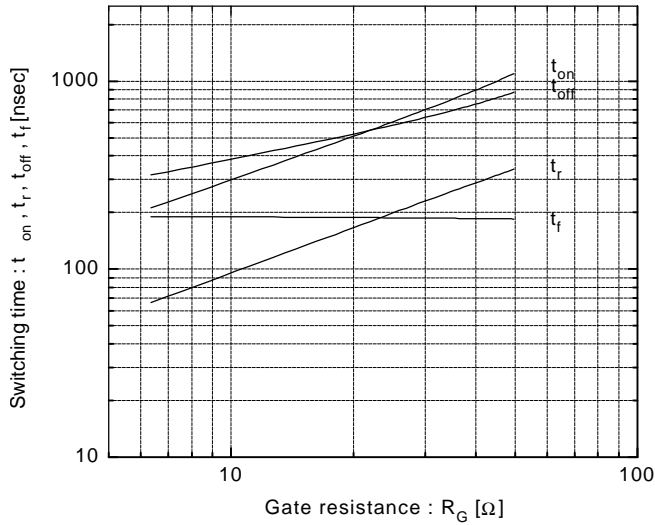

Dynamic input characteristics

$T_J=25^\circ C$

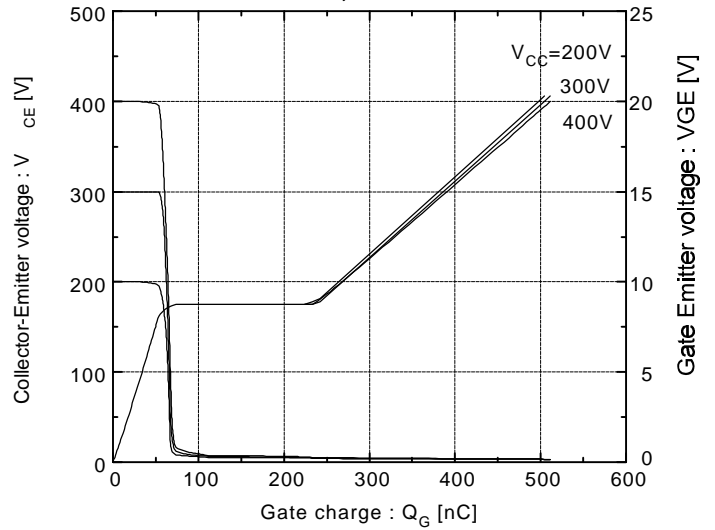

Forward current vs. Forward voltage

$V_{GE}=0V$

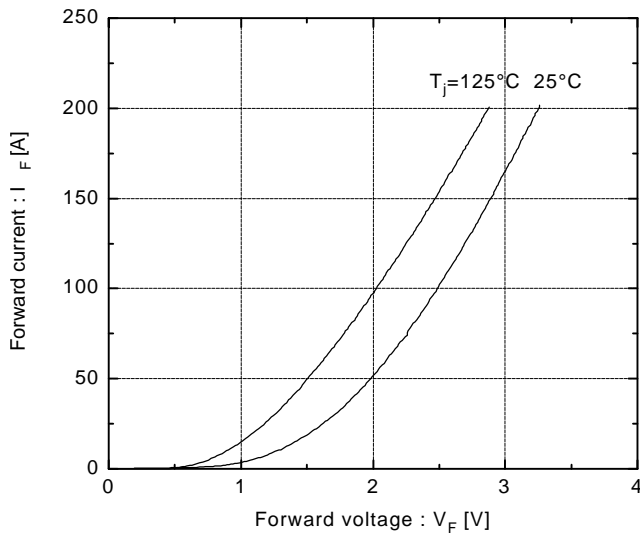

Reverse recovery characteristics

$t_{rr}, I_{rr}$  vs.  $I_F$

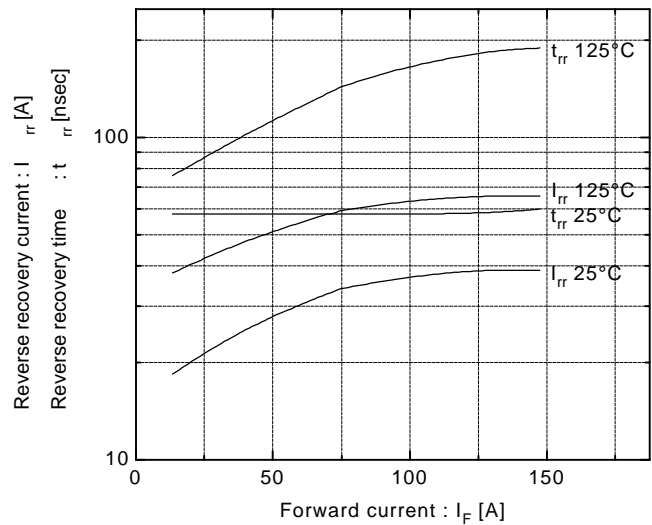

Transient thermal resistance

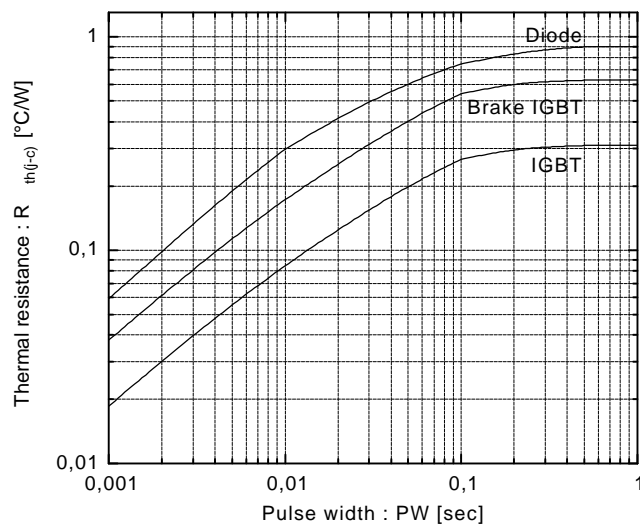

Reversed biased safe operating area

$+V_{GE}=15V, -V_{GE}<15V, T_J\leq 125^\circ C, R_G\geq 24\Omega$

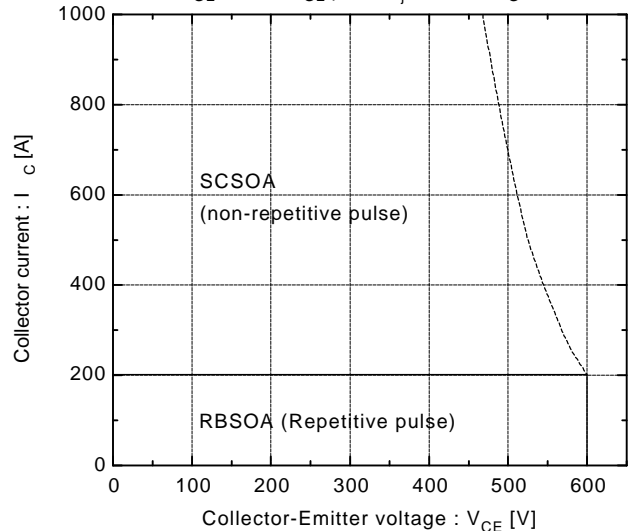

Switching loss vs. Collector current

$V_{CC}=300V, R_G=24\Omega, V_{GE}=\pm 15V$

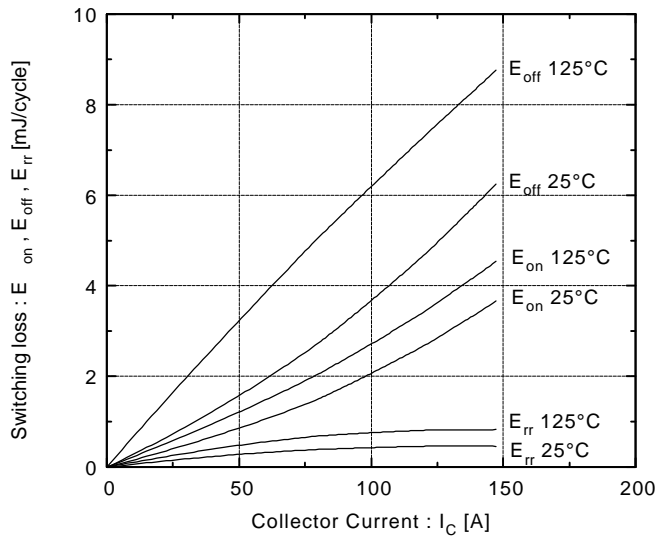

Capacitance vs. Collector-Emitter voltage

$T_J=25^\circ C$

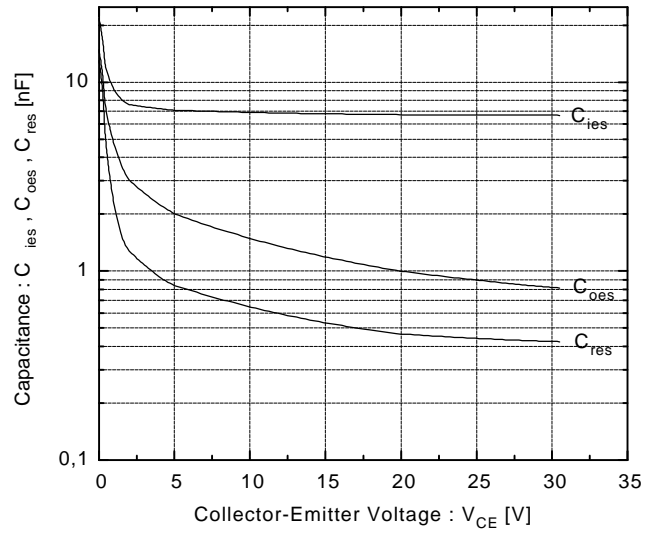

## Brake Chopper IGBT

Collector current vs. Collector-Emittor voltage  
 $T_j=25^\circ\text{C}$

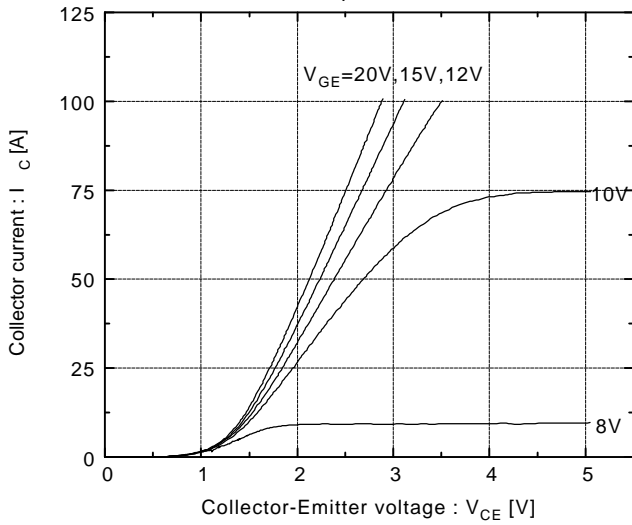

Collector current vs. Collector-Emittor voltage  
 $T_j=125^\circ\text{C}$

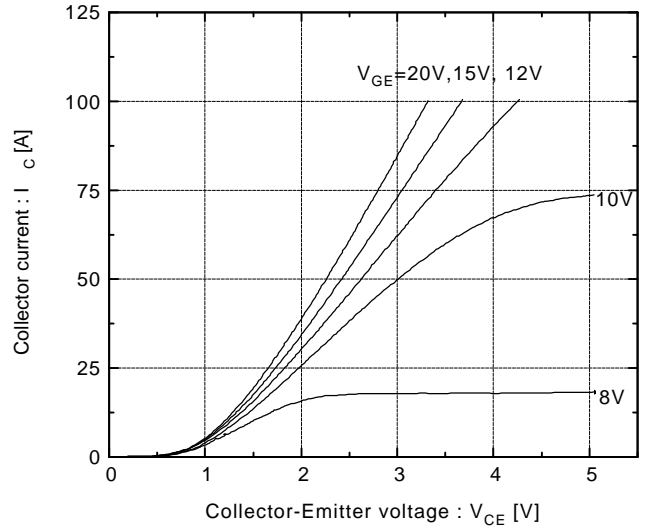

Collector-Emittor vs. Gate-Emittor voltage  
 $T_j=25^\circ\text{C}$

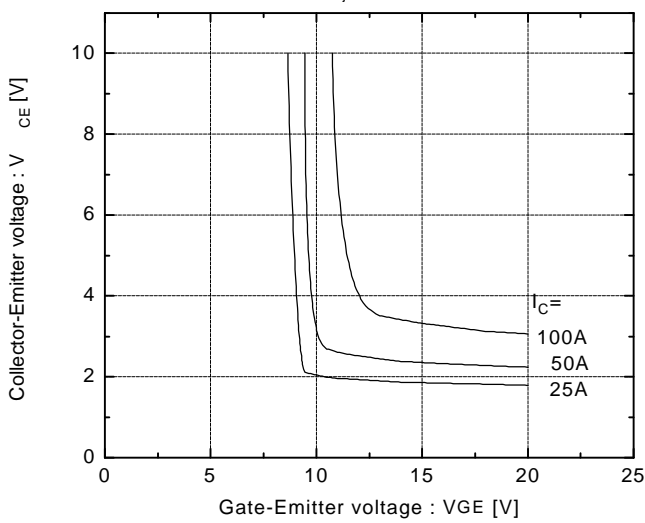

Collector-Emittor vs. Gate-Emittor voltage  
 $T_j=125^\circ\text{C}$

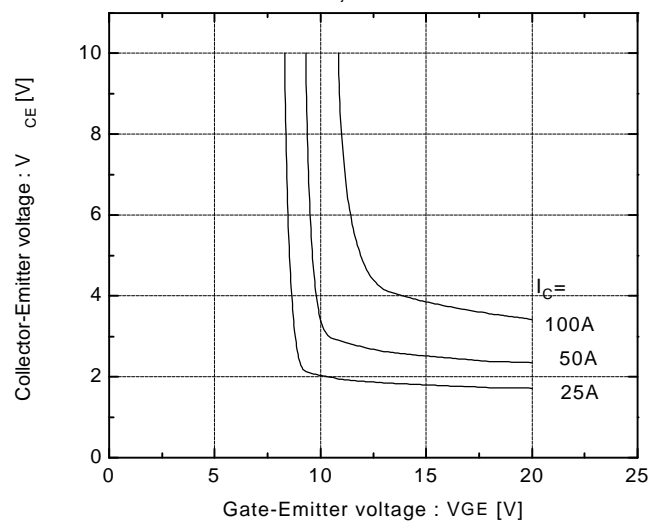

Switching time vs. Collector current  
 $V_{CC}=300\text{V}, R_G=51\Omega, V_{GE}=\pm 15\text{V}, T_j=25^\circ\text{C}$

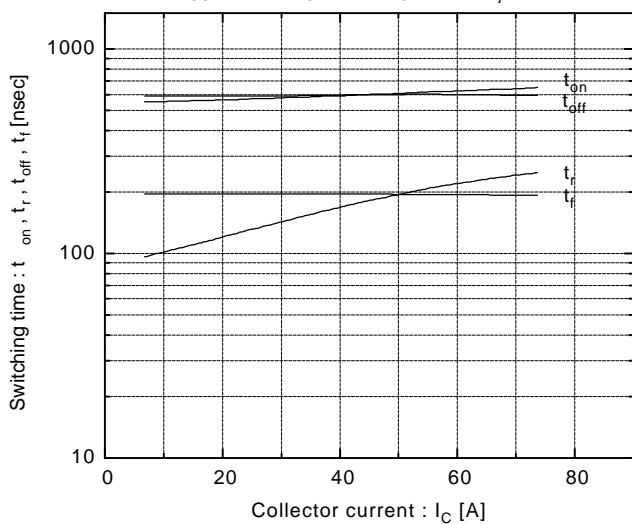

Switching time vs. Collector current  
 $V_{CC}=300\text{V}, R_G=51\Omega, V_{GE}=\pm 15\text{V}, T_j=125^\circ\text{C}$

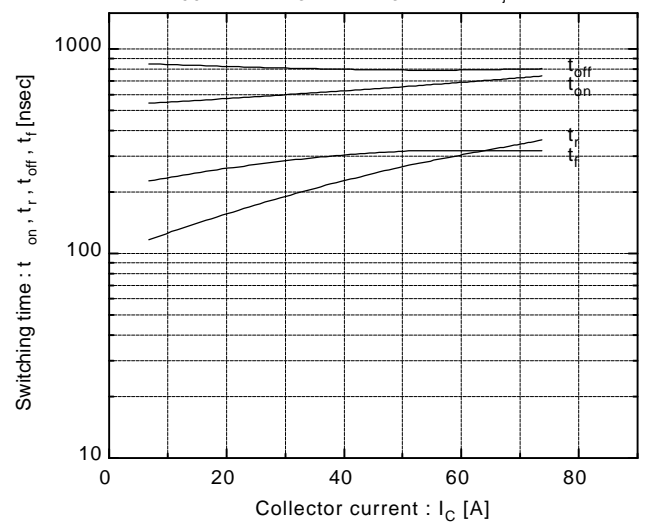

## Brake Chopper IGBT

Switching time vs.  $R_G$

$V_{CC}=300V, I_C=50A, V_{GE}=\pm 15V, T_J=25^\circ C$

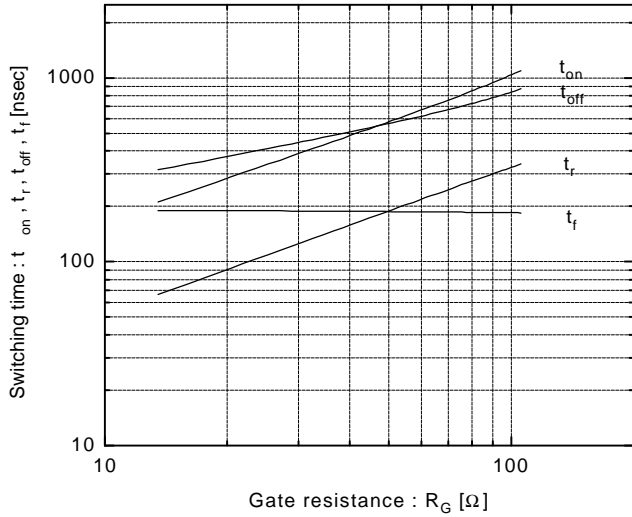

Dynamic input characteristics

$T_J=25^\circ C$

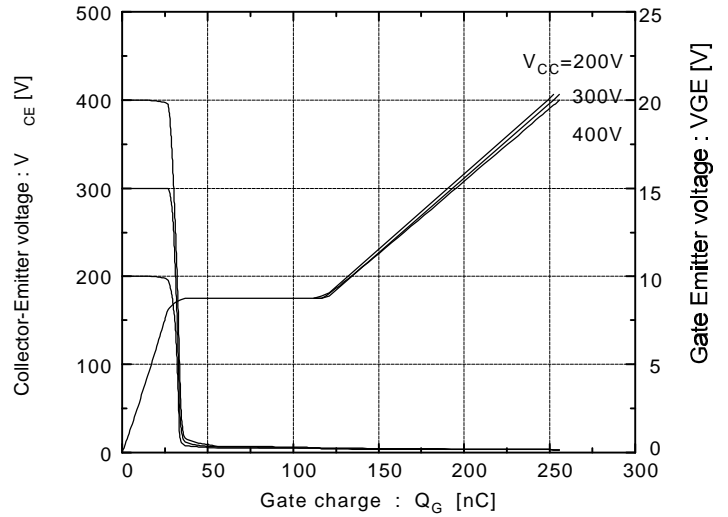

Reversed biased safe operating area

$+V_{GE}=15V, -V_{GE}\leq 15V, T_J\leq 125^\circ C, R_G\geq 51\Omega$

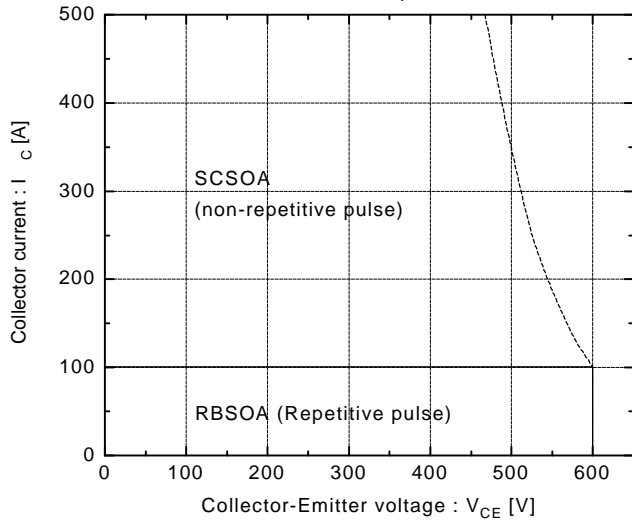

Switching loss vs. Collector current

$V_{CC}=300V, R_G=51\Omega, V_{GE}=\pm 15V$

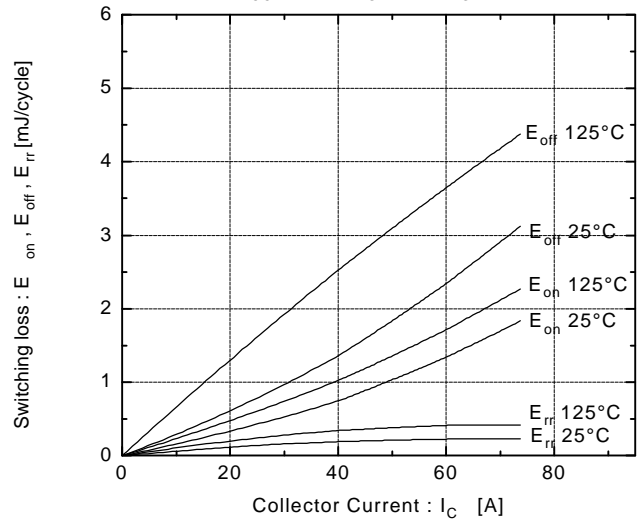

Capacitance vs. Collector-Emitter voltage

$T_J=25^\circ C$

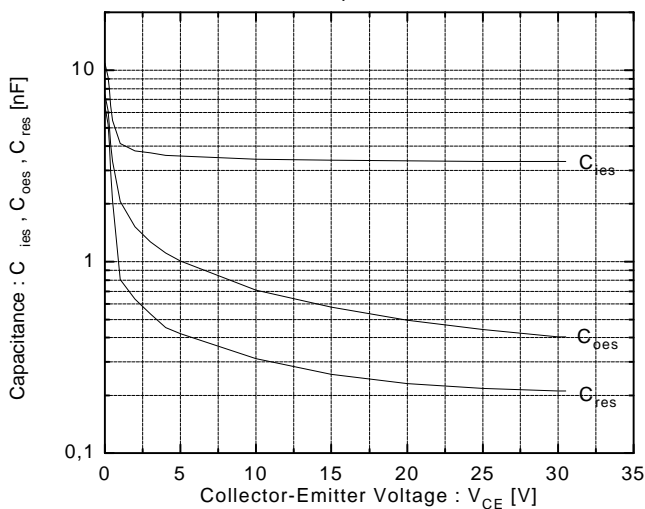

**Fuji Electric GmbH**

Lyoner Straße 26

D-60528 Frankfurt/M

Tel.: 069 - 66 90 29 - 0

Fax.: 069 - 66 90 29 - 56

**Fuji Electric (UK) Ltd.**

Commonwealth House  
2 Chalkhill Road Hammersmith

London W6 8DW, UK

Tel.: 0181 - 233 11 30

Fax.: 0181 - 233 11 60