

Messrs. Rockwell Automation

SPECIFICATION

Device Name : IGBT Module
Type Name : 7MBR10SA140E-01
Spec. No. : MS6M 0548
Date : Jun. - 02 - 2000

This material and the information herein is the property of Fuji Electric Co Ltd They shall be neither reproduced, copied, lent, or disclosed in any way whatsoever for the use of any third party nor used for the manufacturing purposes without the express written consent of Fuji Electric Co., Ltd.

Fuji Electric Co., Ltd.
Matsumoto Factory

DATE	NAME	APPROVED	Fuji Electric Co.,Ltd.	
DRAWN Jun - 2 - '00	<i>F. Kobayashi</i>		DWG. NO.	MS6M 0548
CHECKED June - 2 - 00	<i>S. M. H. C.</i>	<i>T. Miyata</i>		

H04-004-05

Revised Records

Date	Classi- fication	Ind.	Content	Applied date	Drawn	Checked	Approved
Jun-2-'00	enactment	—	—	Issued date	—	S. Mita	T. Miyazaki

This material and the information herein is the property of
 Fuji Electric Co Ltd. They shall be neither reproduced, copied,
 lent, or disclosed in any way whatsoever for the use of any
 third party nor used for the manufacturing purposes without
 the express written consent of Fuji Electric Co., Ltd.

7MBR10SA140E-01

1. Outline Drawing (Unit : mm)

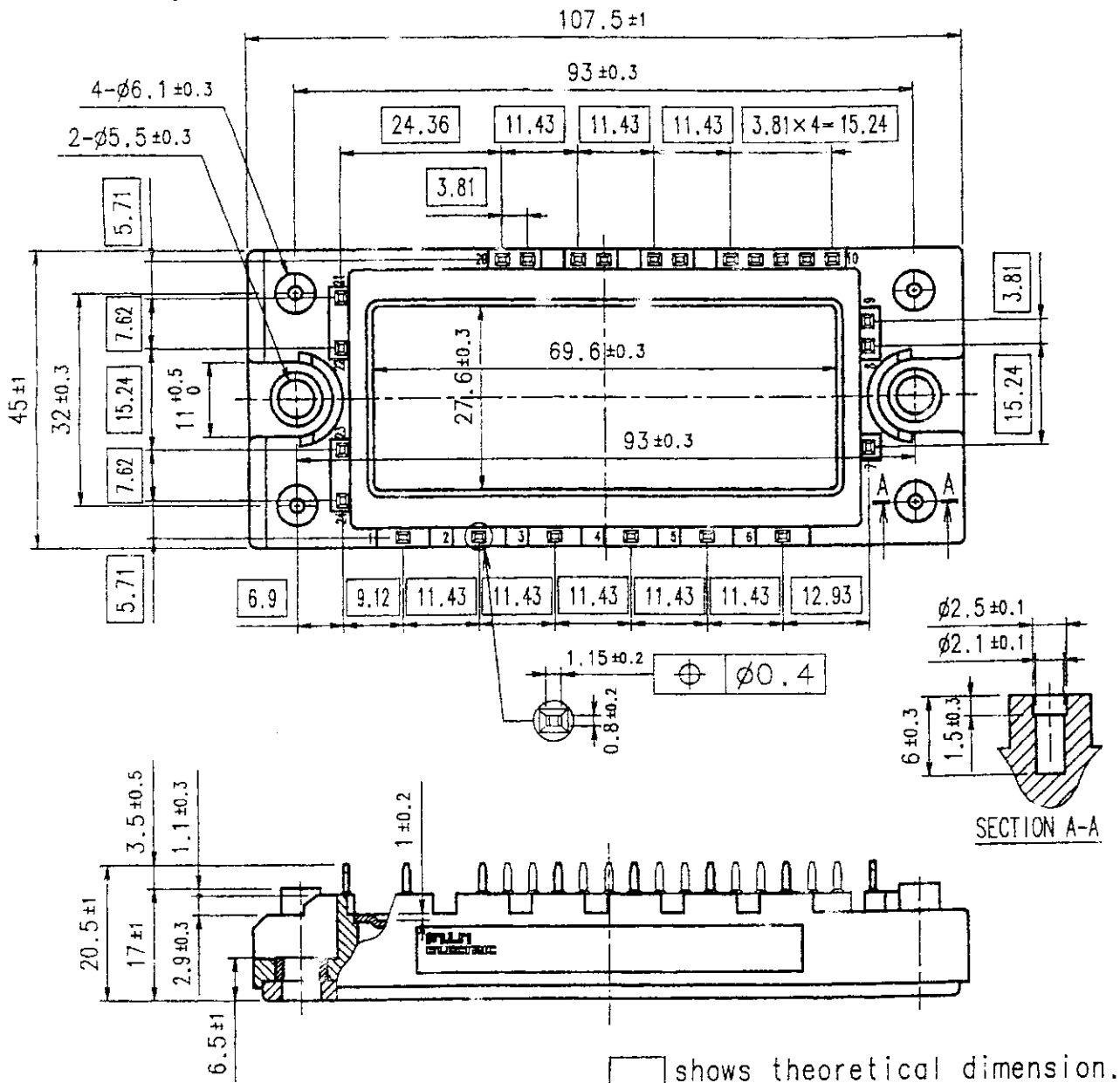

This material and the information herein is the property of Fuji Electric Co., Ltd. They shall be neither reproduced, copied, lent, or disclosed in any way whatsoever for the use of any third party nor used for the manufacturing purposes without the express written consent of Fuji Electric Co., Ltd.

2. Equivalent circuit

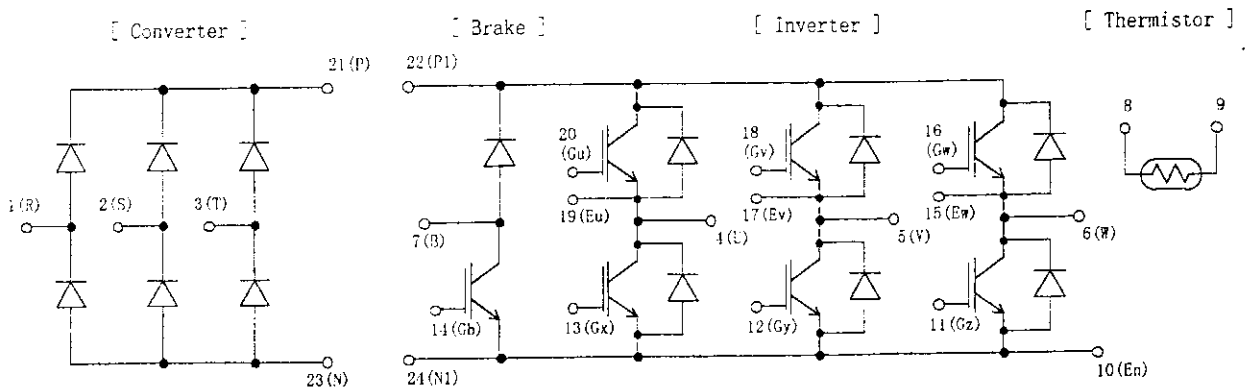

3. Absolute Maximum Ratings (at Tc= 25C unless otherwise specified)

Items		Symbols	Conditions	Maximum Ratings	Units	
Inverter	Collector-Emitter voltage	VCES		1400	V	
	Gate-Emitter voltage	VGES		+20	V	
	Collector current	Ic	Continuous	Tc=25C	15	A
				Tc=75C	10	
		Icp	1ms	Tc=25C	30	A
				Tc=75C	20	
-Ic			10	A		
Collector Power Dissipation	Pc	1 device	75	W		
Brake	Collector-Emitter voltage	VCES		1400	V	
	Gate-Emitter voltage	VGES		+20	V	
	Collector current	Ic	Continuous	Tc=25C	15	A
				Tc=75C	10	
		Icp	1ms	Tc=25C	30	A
				Tc=75C	20	
Collector Power Dissipation	Pc	1 device	75	W		
Repetitive peak reverse Voltage(Diode)	VFRM		1400	V		
Converter	Repetitive peak reverse Voltage	VRRM		1600	V	
	Average Output Current	Io	50Hz/60Hz sine wave	25	A	
	Surge Current (Non-Repetitive)	IFSM	Tj=150C,10ms	260	A	
	I ² t (Non-Repetitive)	I ² t	half sine wave	338	A ² s	
Junction temperature	Tj		150	C		
Storage temperature	Tstg		-40~ +125	C		
Isolation voltage	between terminal and copper base ^(*1)	Viso	AC : 1min.	2500	V	
	between thermistor and others ^(*2)			2500	V	
Mounting Screw Torque ^(*3)				3.5	Nm	

(*1) All terminals should be connected together when isolation test will be done.

(*2) Terminal 8 and 9 should be connected together. Terminal 1 to 7 and 10 to 24 should be connected together and shorted to copper base.

(*3) Recommendable Value : 2.5~3.5 Nm (M5)

This material and the information herein is the property of Fuji Electric Co. Ltd. They shall be neither reproduced, copied, lent, or disclosed in any way whatsoever for the use of any third party nor used for the manufacturing purposes without the express written consent of Fuji Electric Co. Ltd.

4. Electrical characteristics (at Tj= 25C unless otherwise specified)

Items	Symbols	Conditions	Characteristics			Units		
			min.	typ.	Max.			
Inverter	Zero gate voltage Collector current	ICES	VGE 0 V, VCE 1400 V			1.0	mA	
	Gate-Emitter leakage current	IGES	VCE 0 V, VGE +-20 V			200	nA	
	Gate-Emitter threshold voltage	VGE(th)	VCE 20 V, Ic = 10 mA	5.5	7.2	8.5	V	
	Collector-Emitter saturation voltage	VCE(sat)	VGE 15 V, chip		2.2			V
			Ic = 10 A, terminal		2.25	2.7		
	Input capacitance	Cies	VGE 0 V, VCE 10 V f = 1 MHz		1200			pF
	Turn-on time	ton	Vcc= 800 V		0.35	1.2		us
		tr	Ic = 10 A		0.25	0.6		
		tr(θ)	VGE +-15 V		0.1			
	Turn-off time	toff	RG = 120 ohm		0.45	1.0		us
		tf			0.08	0.3		
Forward on voltage	VF	IF = 10 A, chip		2.4			V	
		terminal		2.45	3.3			
Reverse recovery time	trr	IF = 10 A				350	ns	
Brake	Zero gate voltage Collector current	ICES	VGE 0 V, VCE 1400 V			1.0	mA	
	Gate-Emitter leakage current	IGES	VCE 0 V, VGE +-20 V			200	nA	
	Collector-Emitter saturation voltage	VCE(sat)	VGE 15 V, chip		2.2			V
			Ic = 10 A, terminal		2.3	2.7		
	Turn-on time	ton	Vcc= 800 V		0.35	1.2		us
		tr	Ic = 10 A		0.25	0.6		
	Turn-off time	toff	VGE +-15 V		0.45	1.0		us
tf		RG = 120 ohm		0.08	0.3			
Reverse current	IRRM	VR = 1400 V				1.0	mA	
Converter	Forward on voltage	VFM	IF = 10 A, chip		1.0		V	
			terminal		1.1	1.5		
Reverse current	IRRM	VR = 1600 V				1.0	mA	
Thermistor	Resistance	R	T = 25C		5000		ohm	
			T = 100C	465	495	520		
	B value	B	T = 25/50C	3305	3375	3450	K	

5. Thermal resistance characteristics

Items	Symbols	Conditions	Characteristics			Units
			min.	typ.	Max.	
Thermal resistance (1 device)	Rth(j-c)	Inverter IGBT			1.67	C/W
		Inverter FWD			2.78	
		Brake IGBT			1.67	
		Converter Diode			0.90	
Contact Thermal resistance	Rth(c-f)	with Thermal Compound (*)		0.05		C/W

* This is the value which is defined mounting on the additional cooling fin with thermal compound.

6. Indication on module

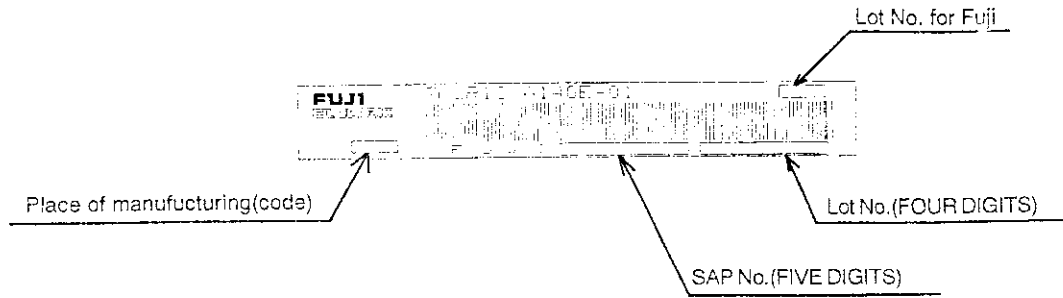

7. Applicable category

This specification is applied to Power Integrated Module named 7MBR10SA140E-01 .

8. Storage and transportation notes (保管・運搬上の注意事項)

- The module should be stored at a standard temperature of 5 to 35°C and humidity of 45 to 75% .
- Store modules in a place with few temperature changes in order to avoid condensation on the module surface.
- Avoid exposure to corrosive gases and dust.
- Avoid excessive external force on the module.
- Store modules with unprocessed terminals.
- Do not drop or otherwise shock the modules when transporting.
- Please connect adequate fuse or protector of circuit between three-phase line and this product to prevent the equipment from causing secondary destruction.

9. Definitions of switching time

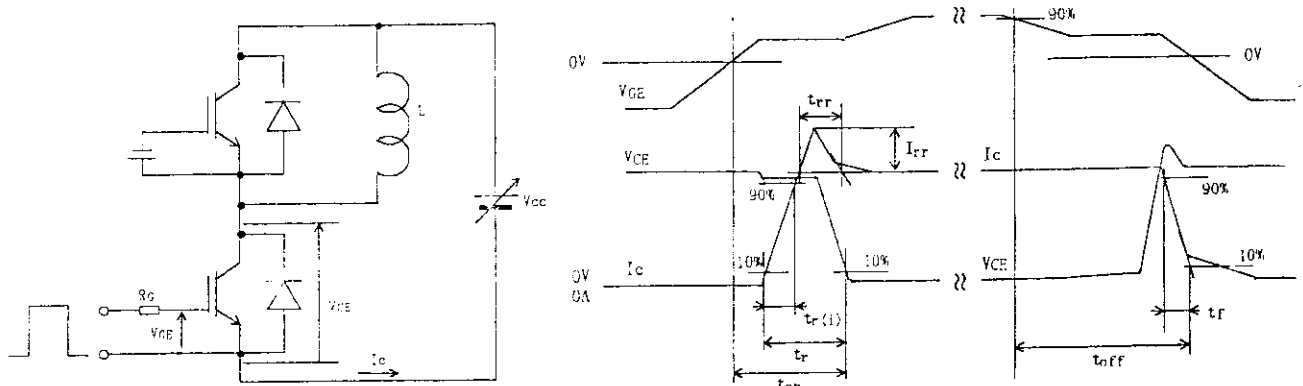

This material and the information herein is the property of Fuji Electric Co. Ltd. They shall be neither reproduced, copied, lent, or disclosed in any way whatsoever for the use of any third party nor used for the manufacturing purposes without the express written consent of Fuji Electric Co., Ltd.

This material and the information herein is the property of Fuji Electric Co. Ltd. They shall be neither reproduced, copied, lent, or disclosed in any way whatsoever for the use of any third party nor used for the manufacturing purposes without the express written consent of Fuji Electric Co. Ltd.

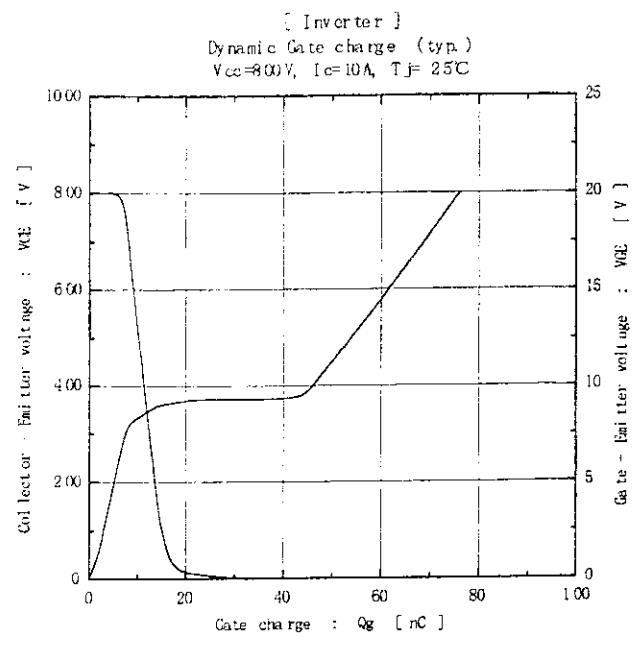
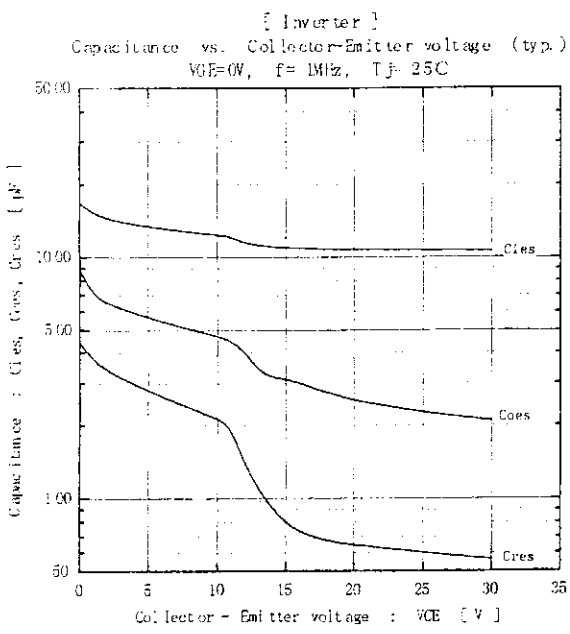
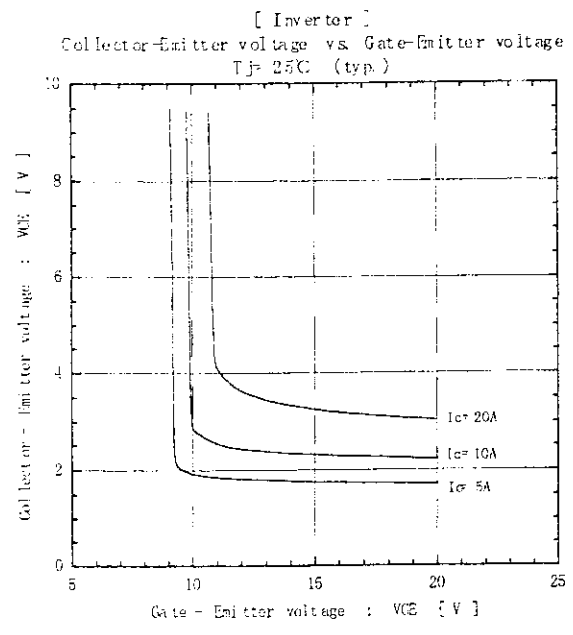
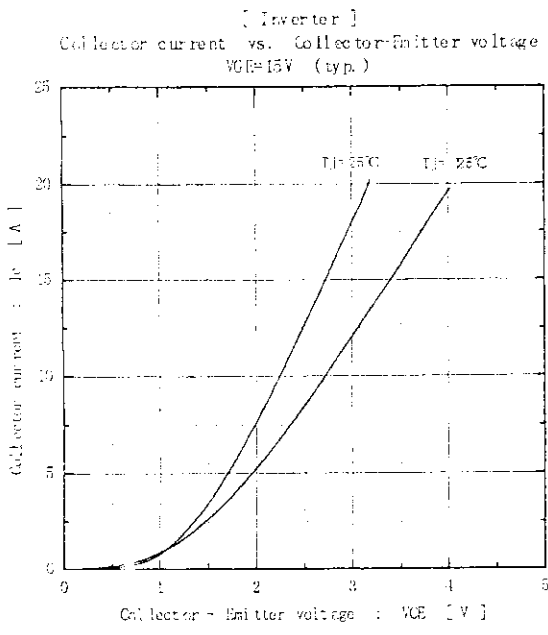
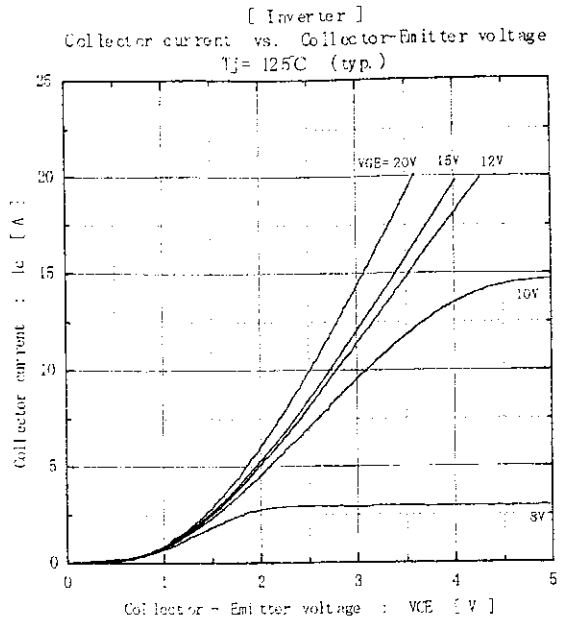
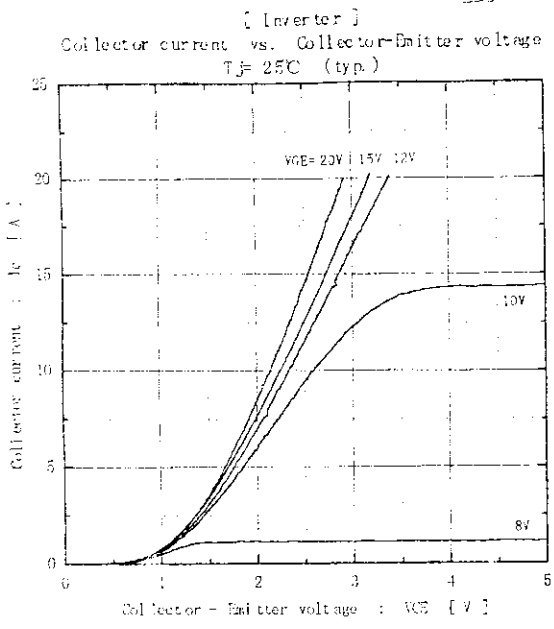

Fuji Electric Co., Ltd.

DWG. NO.

MS6M 0548

7 / 10

H04-004-03

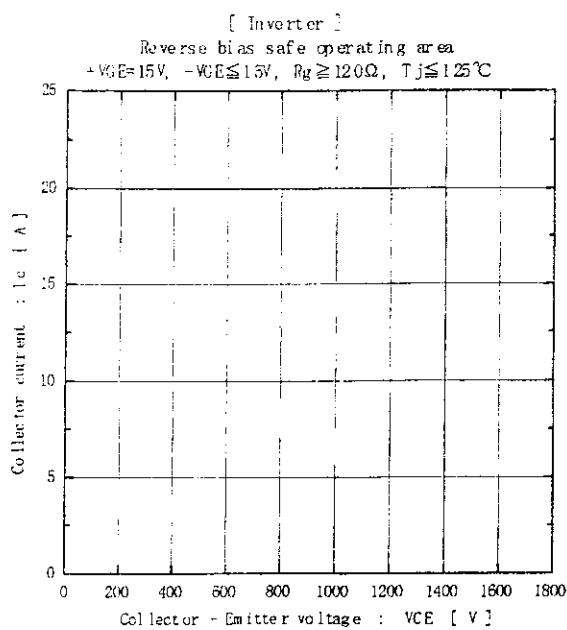
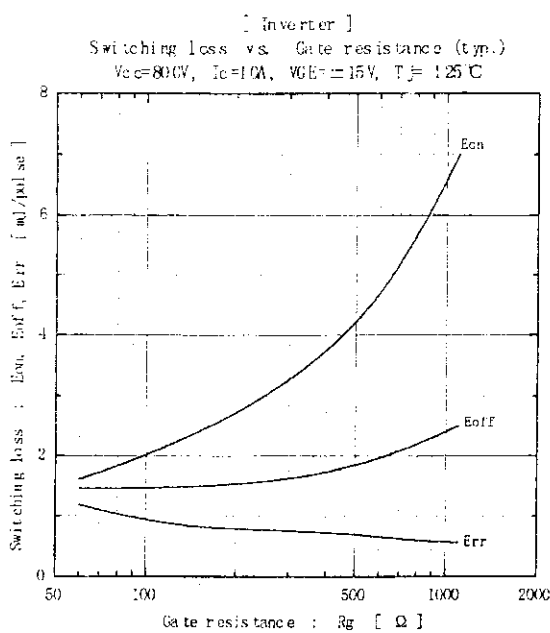
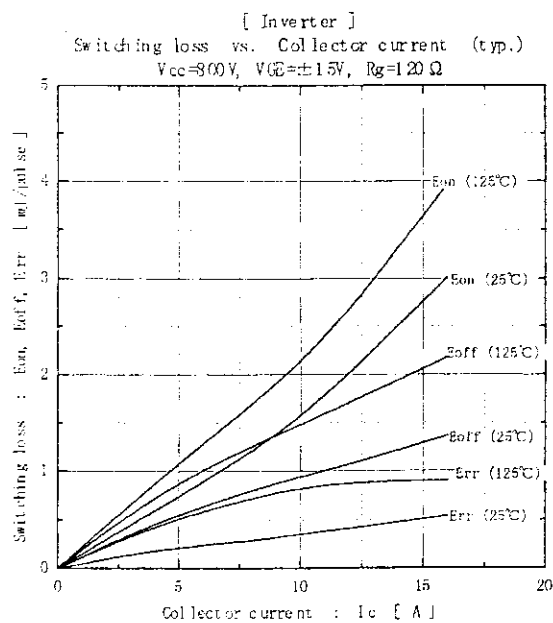
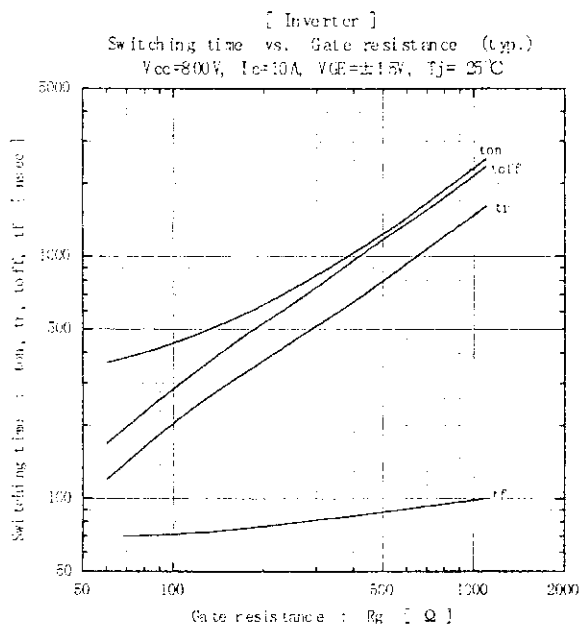
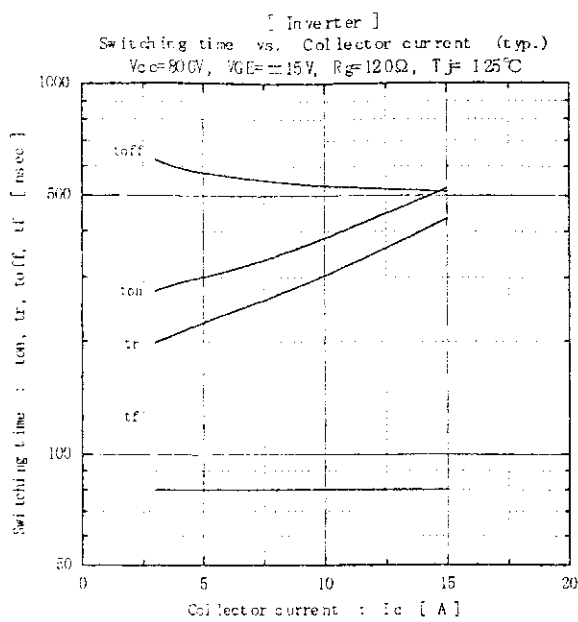
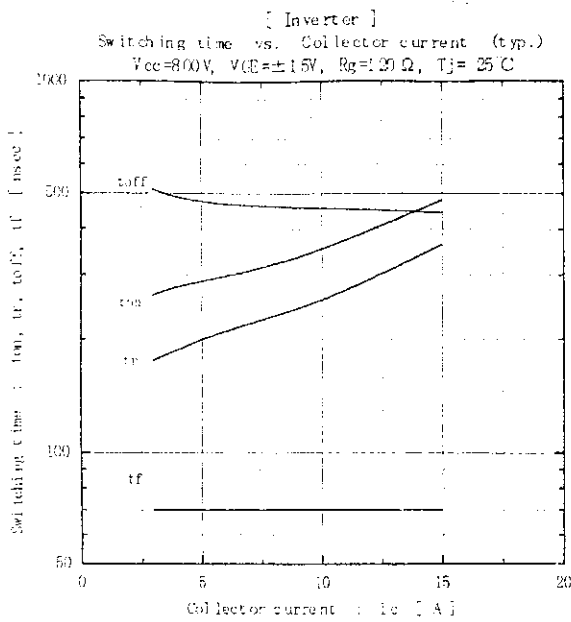

This material and the information herein is the property of Fuji Electric Co. Ltd. They shall be neither reproduced, copied, lent, or disclosed in any way whatsoever for the use of any third party nor used for the manufacturing purposes without the express written consent of Fuji Electric Co., Ltd.

This material and the information herein is the property of Fuji Electric Co., Ltd. They shall be neither reproduced, copied, lent, or disclosed in any way whatsoever for the use of any third party, nor used for the manufacturing purposes without the express written consent of Fuji Electric Co., Ltd.

[Inverter]
Forward current vs. Forward on voltage (typ.)

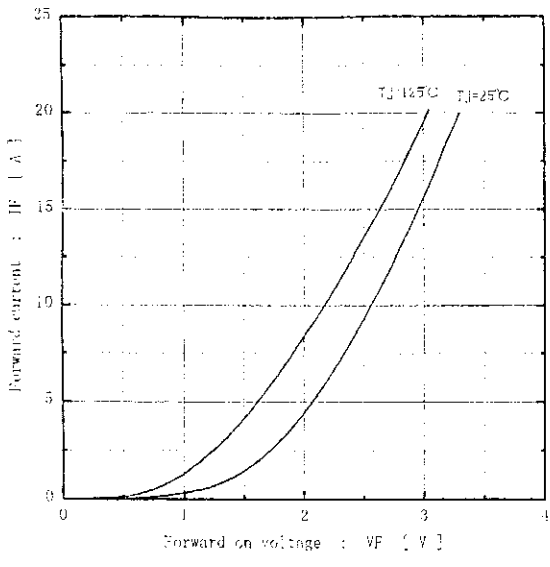

[Inverter]
Reverse recovery characteristics (typ.)
Vcc=800V, VGE=±15V, Rg=120Ω

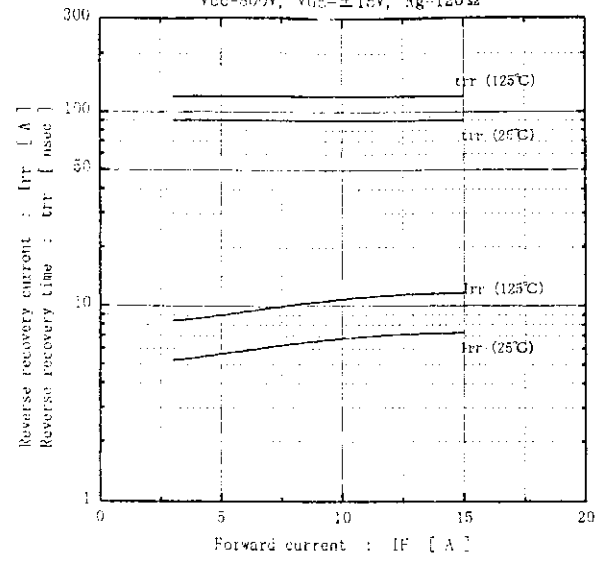

[Converter]
Forward current vs. Forward on voltage (typ.)

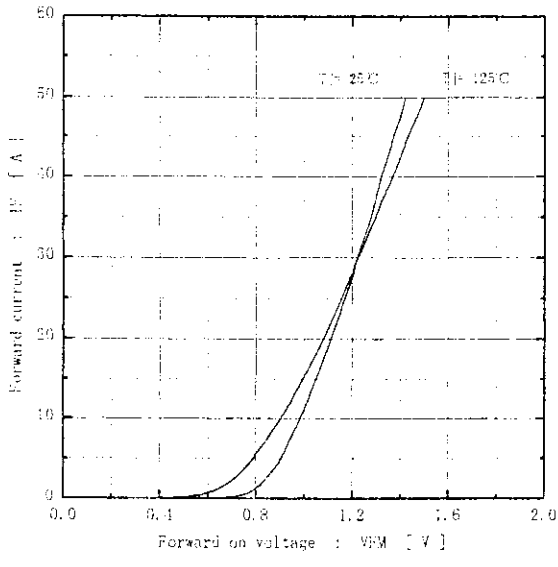

Transient thermal resistance

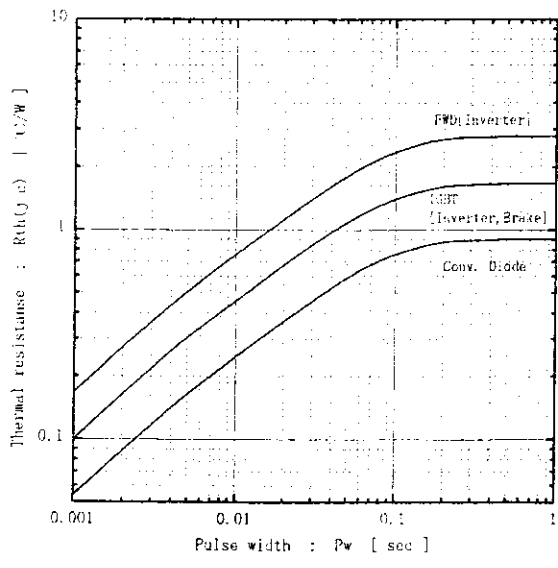

[Thermistor]
Temperature characteristic (typ.)

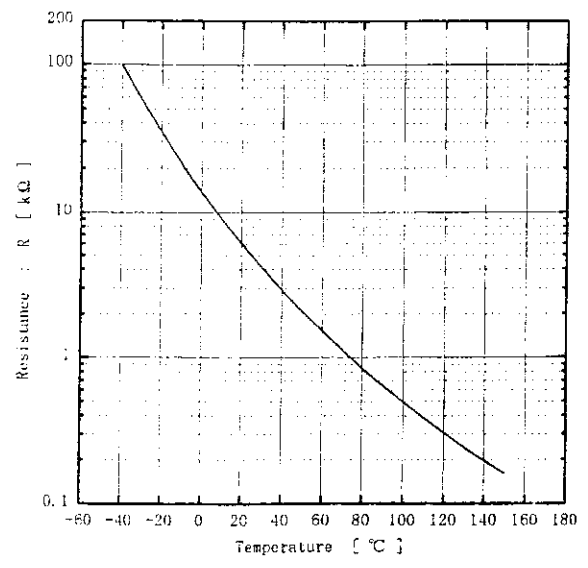

Fuji Electric Co., Ltd.

DWG. NO.

MS6M 0548

9/10

This material and the information herein is the property of Fuji Electric Co. Ltd. They shall be neither reproduced, copied, lent, or disclosed in any way whatsoever for the use of any third party nor used for the manufacturing purposes without the express written consent of Fuji Electric Co. Ltd.

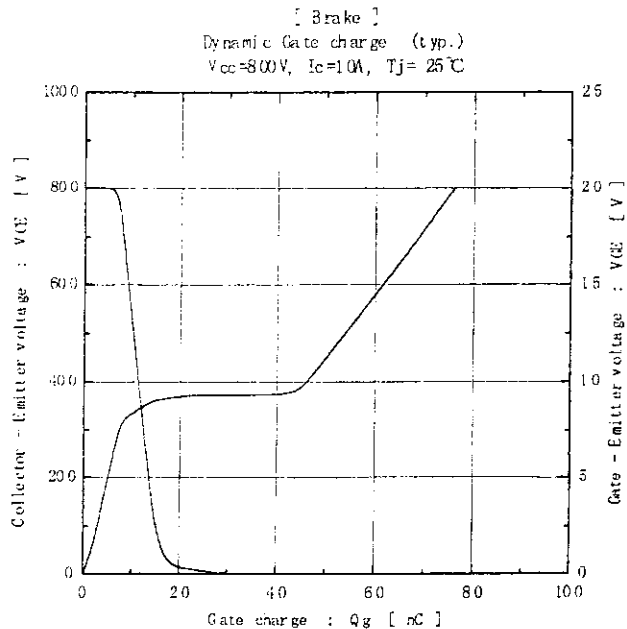
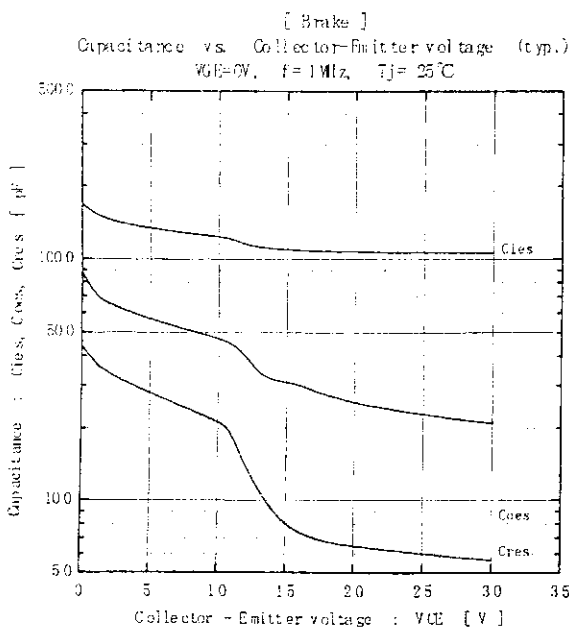
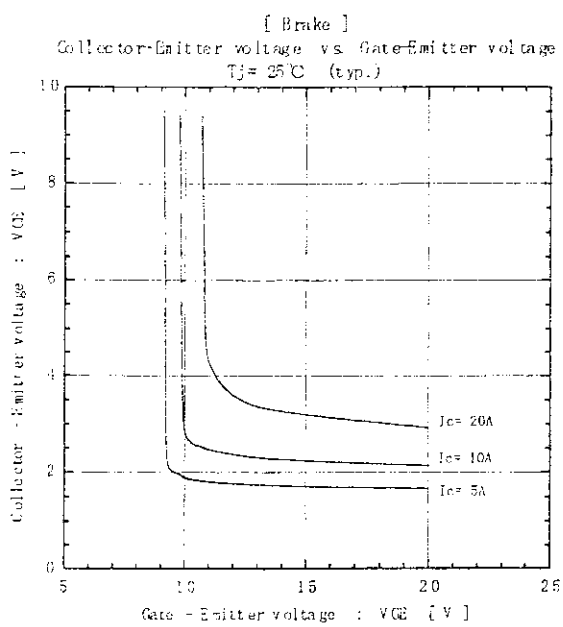
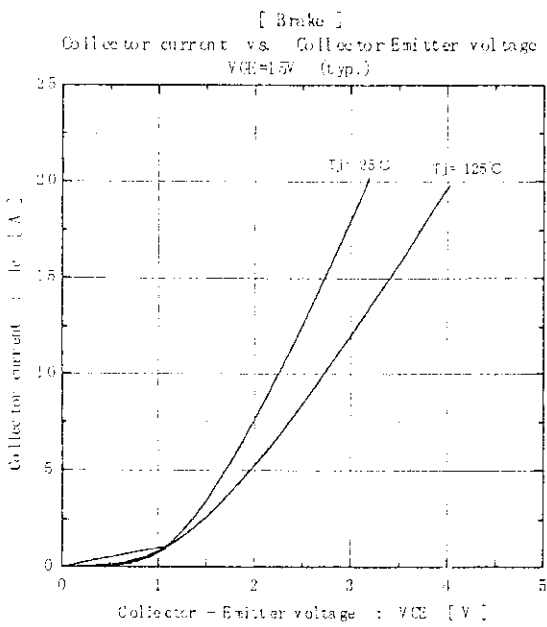
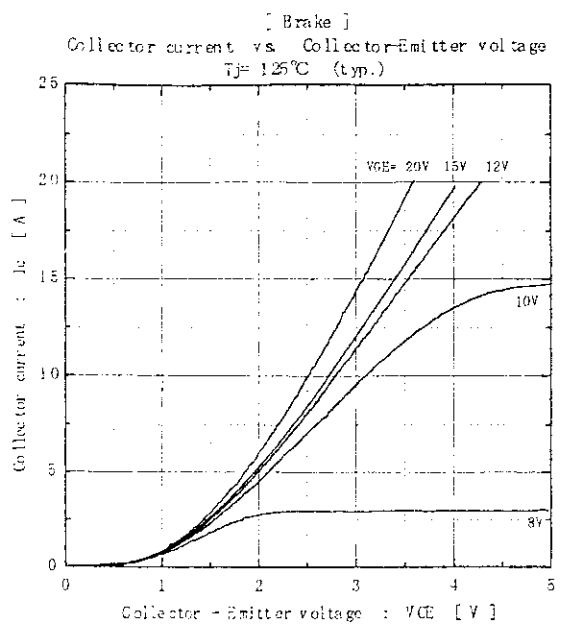
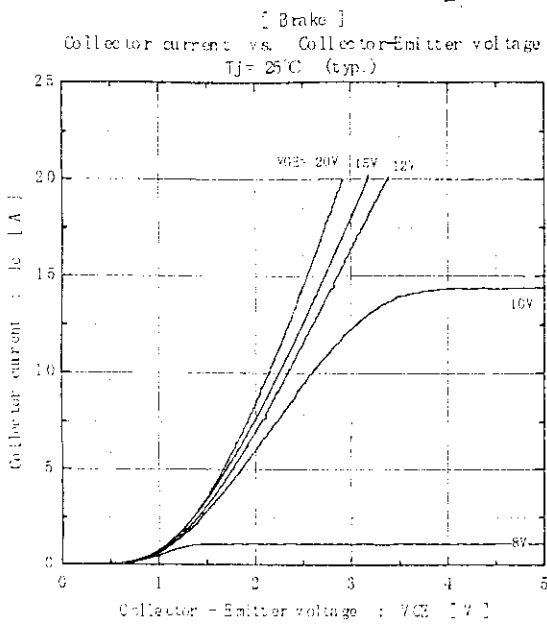

Fuji Electric Co., Ltd

DWG. NO.

MS6M 0548

10/10